



*economies*

Special Issue Reprint

---

# The Impact of COVID-19 on Financial Markets and the Real Economy

---

Edited by  
Ștefan Cristian Gherghina

[www.mdpi.com/journal/economies](http://www.mdpi.com/journal/economies)



# **The Impact of COVID-19 on Financial Markets and the Real Economy**



# The Impact of COVID-19 on Financial Markets and the Real Economy

Editor

**Ștefan Cristian Gherghina**

MDPI • Basel • Beijing • Wuhan • Barcelona • Belgrade • Manchester • Tokyo • Cluj • Tianjin



*Editor*

Ștefan Cristian Gherghina  
Bucharest University of Economic Studies  
Romania

*Editorial Office*

MDPI  
St. Alban-Anlage 66  
4052 Basel, Switzerland

This is a reprint of articles from the Special Issue published online in the open access journal *Economies* (ISSN 2227-7099) (available at: [https://www.mdpi.com/journal/economies/special\\_issues/Impact\\_COVID\\_19\\_Financial\\_Markets\\_Real\\_Economy](https://www.mdpi.com/journal/economies/special_issues/Impact_COVID_19_Financial_Markets_Real_Economy)).

For citation purposes, cite each article independently as indicated on the article page online and as indicated below:

LastName, A.A.; LastName, B.B.; LastName, C.C. Article Title. *Journal Name* **Year**, *Volume Number*, Page Range.

**ISBN 978-3-0365-7796-8 (Hbk)**

**ISBN 978-3-0365-7797-5 (PDF)**

© 2023 by the authors. Articles in this book are Open Access and distributed under the Creative Commons Attribution (CC BY) license, which allows users to download, copy and build upon published articles, as long as the author and publisher are properly credited, which ensures maximum dissemination and a wider impact of our publications.

The book as a whole is distributed by MDPI under the terms and conditions of the Creative Commons license CC BY-NC-ND.

# Contents

About the Editor . . . . . vii

**Stefan Cristian Gherghina**

The Impact of COVID-19 on Financial Markets and the Real Economy  
Reprinted from: *Economies* **2023**, *11*, 107, doi:10.3390/economies11040107 . . . . . 1

**Da Van Huynh, Thuy Thi Kim Truong, Long Hai Duong, Nhan Trong Nguyen,  
Giang Vu Huong Dao and Canh Ngoc Dao**

The COVID-19 Pandemic and Its Impacts on Tourism Business in a Developing City: Insight  
from Vietnam  
Reprinted from: *Economies* **2021**, *9*, 172, doi:10.3390/economies9040172 . . . . . 7

**Han-Sol Lee, Ekaterina A. Degtereva and Alexander M. Zobov**

The Impact of the COVID-19 Pandemic on Cross-Border Mergers and Acquisitions'  
Determinants: New Empirical Evidence from Quasi-Poisson and Negative Binomial  
Regression Models  
Reprinted from: *Economies* **2021**, *9*, 184, doi:10.3390/economies9040184 . . . . . 25

**Ana Belén Tulcanaza-Prieto and Manuel Eugenio Morocho-Cayamcela**

The Evolution and Takeoff of the Ecuadorian Economic Groups  
Reprinted from: *Economies* **2021**, *9*, 188, doi:10.3390/economies9040188 . . . . . 39

**Nikolaos Rodousakis and George Soklis**

The Impact of COVID-19 on the US Economy: The Multiplier Effects of Tourism  
Reprinted from: *Economies* **2022**, *10*, 2, doi:10.3390/economies10010002 . . . . . 55

**Greta Keliuotyte-Staniulieniene and Julius Kviklis**

Stock Market Reactions during Different Phases of the COVID-19 Pandemic: Cases of Italy  
and Spain  
Reprinted from: *Economies* **2022**, *10*, 3, doi:10.3390/economies10010003 . . . . . 63

**Taufiq Hidayat, Dian Masyita, Sulaeman Rahman Nidar, Fauzan Ahmad  
and Muhammad Adrissa Nur Syarif**

Early Warning Early Action for the Banking Solvency Risk in the COVID-19 Pandemic Era:  
A Case Study of Indonesia  
Reprinted from: *Economies* **2022**, *10*, 6, doi:10.3390/economies10010006 . . . . . 95

**Hung Van Vu and Huong Ho**

Analysis of Factors Influencing Credit Access of Vietnamese Informal Labors in the Time of  
COVID-19 Pandemic  
Reprinted from: *Economies* **2022**, *10*, 8, doi:10.3390/economies10010008 . . . . . 117

**Vikkram Singh, Homayoun Shirazi and Jessica Turetken**

The COVID-19 Era—Influencers of Uneven Sector Performance: A Canadian Perspective  
Reprinted from: *Economies* **2022**, *10*, 40, doi:10.3390/economies10020040 . . . . . 129

**Ghada A. Altarawneh, Ahmad B. Hassanat, Ahmad S. Tarawneh, Ahmad Abadleh,  
Malek Alrashidi and Mansoor Alghamdi**

Stock Price Forecasting for Jordan Insurance Companies Amid the COVID-19 Pandemic  
Utilizing Off-the-Shelf Technical Analysis Methods  
Reprinted from: *Economies* **2022**, *10*, 43, doi:10.3390/economies10020043 . . . . . 153

<b>Nguyen Vinh Khuong, Nguyen Thi Thanh Phuong, Nguyen Thanh Liem, Cao Thi Mien Thuy and Tran Hung Son</b> Factors Affecting the Intention to Use Financial Technology among Vietnamese Youth: Research in the Time of COVID-19 and Beyond Reprinted from: <i>Economies</i> <b>2022</b> , <i>10</i> , 57, doi:10.3390/economies10030057 . . . . .	<b>171</b>
<b>Zohal Habibi, Hamed Habibi and Mohammad Aqa Mohammadi</b> The Potential Impact of COVID-19 on the Chinese GDP, Trade, and Economy Reprinted from: <i>Economies</i> <b>2022</b> , <i>10</i> , 73, doi:10.3390/economies10040073 . . . . .	<b>189</b>
<b>Dmitriy Rodionov, Anastasia Ivanova, Olga Konnikova and Evgenii Konnikov</b> Impact of COVID-19 on the Russian Labor Market: Comparative Analysis of the Physical and Informational Spread of the Coronavirus Reprinted from: <i>Economies</i> <b>2022</b> , <i>10</i> , 136, doi:10.3390/economies10060136 . . . . .	<b>205</b>
<b>Trung Duc Nguyen, Anh Hoang Le, Eleftherios I. Thalassinos and Lanh Kim Trieu</b> The Impact of the COVID-19 Pandemic on Economic Growth and Monetary Policy: An Analysis from the DSGE Model in Vietnam Reprinted from: <i>Economies</i> <b>2022</b> , <i>10</i> , 159, doi:10.3390/economies10070159 . . . . .	<b>227</b>
<b>Anna Tanina, Larissa Tashenova, Yevgeni Konyshev, Dinara Mamrayeva and Dmitriy Rodionov</b> The Tourist and Recreational Potential of Cross-Border Regions of Russia and Kazakhstan during the COVID-19 Pandemic: Estimation of the Current State and Possible Risks Reprinted from: <i>Economies</i> <b>2022</b> , <i>10</i> , 201, doi:10.3390/economies10080201 . . . . .	<b>247</b>
<b>Joost R. Santos, John Frederick D. Tapia, Albert Lamberte, Christine Alyssa Solis, Raymond R. Tan, Kathleen B. Aviso and Krista Danielle S. Yu</b> Uncertainty Analysis of Business Interruption Losses in the Philippines Due to the COVID-19 Pandemic Reprinted from: <i>Economies</i> <b>2022</b> , <i>10</i> , 202, doi:10.3390/economies10080202 . . . . .	<b>275</b>
<b>Lucia Svabova, Katarina Kramarova and Dominika Chabadova</b> Impact of the COVID-19 Pandemic on the Business Environment in Slovakia Reprinted from: <i>Economies</i> <b>2022</b> , <i>10</i> , 244, doi:10.3390/economies10100244 . . . . .	<b>293</b>
<b>Sergey Mikhailovich Vasin</b> Comparative Analysis of Socioeconomic Models in COVID-19 Pandemic Reprinted from: <i>Economies</i> <b>2022</b> , <i>10</i> , 278, doi:10.3390/economies10110278 . . . . .	<b>315</b>

## About the Editor

### **Ștefan Cristian Gherghina**

Ștefan Cristian Gherghina, PhD., Habil., is a Professor of the Department of Finance, Faculty of Finance and Banking, and PhD supervisor at the Finance Doctoral School, Bucharest University of Economic Studies, Romania. His areas of interest are corporate finance, corporate governance, quantitative finance, portfolio management, and sustainable development. He has authored and co-authored several books, as well as articles published in top journals, and exhibited his studies at many international conferences. He serves as a referee for various leading journals, and is also Editorial Board Member of the *Economies* and *Journal of Risk and Financial Management*, among other journals indexed in Clarivate Analytics, Web of Science, Social Sciences Citation Index (SSCI), Science Citation Index Expanded (SCIE), Emerging Sources Citation Index (ESCI), and further reputed international databases.





Editorial

# The Impact of COVID-19 on Financial Markets and the Real Economy

Stefan Cristian Gherghina

Department of Finance, Bucharest University of Economic Studies, 6 Piata Romana, 010374 Bucharest, Romania; stefan.gherghina@fin.ase.ro

The emergence of the novel coronavirus in December 2019 manifested in an expanding prevalence of confirmed cases worldwide, posing a significant challenge to international healthcare safety; with this incident, the notion of “regular life” shifted (Güven et al. 2022). On 11 March 2020, the World Health Organization (WHO) proclaimed pneumonia triggered by the novel coronavirus—referred to as COVID-19—to be a global pandemic (Zhong and Lin 2022). The top ten nations in terms of confirmed cumulative COVID-19 cases were the United States, Spain, Russia, the United Kingdom, Italy, Brazil, France, Germany, Turkey, and Iran (Bouteska et al. 2023). The contagion had a detrimental influence on both the real and monetary dimensions of the economy in advanced, emerging, and developing countries. Many industries, particularly airline companies, tourism and travel organizations, and resorts, have had significant challenges in sustaining their revenue streams (Uddin et al. 2022). Unlike the 2007–2009 economic meltdown, the COVID-19 pandemic was not caused by problematic market situation or reckless financial policy; it was, in fact, completely unpredicted (Hsu and Tang 2022). Moreover, it contrasted from other earlier dramatic events caused by economic and financial circumstances, including the Asian financial crisis in 1997–1998 or the European debt crisis in 2010–2013 (Dong et al. 2022). Nevertheless, the similarity of these downturns is that they commenced in one nation or area and spread rapidly to other markets, prompting considerable disruption in the worldwide financial system (Zhang et al. 2022). Thus, COVID-19 has been regarded as an “exogenous shock” or potentially a “black swan”, as it was such a rare occurrence that has major repercussions for stock markets without any reasonable anticipation (Costola et al. 2023).

The COVID-19 pandemic has resulted in impressive countermeasures to limit the propagation of the virus, such as worldwide and local travel bans, lockdowns, and quarantines, which have caused rapid and lengthy disruptions to the majority of businesses and industries (Yarovaya et al. 2021). To restrict the virus’s propagation and to mitigate or avoid its effect on the economy and financial markets (Iyke and Maheepala 2022), governments all over the world implemented fiscal recovery measures, with main fiscal strategies comprising automatic insurance mechanisms, social security systems, tax breaks, and subsidies (Sariyer et al. 2023). In addition, central banks have decreased interest rates near zero, lowered reserve ratios, and expanded repurchase operations to mitigate the effects of the outbreak (To et al. 2023). However, because of poor overall health and pre-existing conditions in the community, a shortage of adequate public healthcare resources, an upsurge in the unemployment rate, and deficient leadership, developing countries have suffered more from COVID-19 than developed economies (Tortorella et al. 2021).

The financial markets witnessed substantial changes following the global diffusion of COVID-19 (Jin et al. 2022). Liu et al. (2021) proved that COVID-19 raised the likelihood of a stock market meltdown. Accordingly, the S&P500 and S&P Europe 350 lost more than a third of their value on 23 March 2020, relative to their historical high on 19 February 2020, with a 12% single-day drop in mid-March (Martins and Cró 2022). The Dow Jones Industrial Average fell to 7.79% on 9 March 2020, and then plunged to 9.9% on 12 March

**Citation:** Gherghina, Stefan Cristian. 2023. The Impact of COVID-19 on Financial Markets and the Real Economy. *Economies* 11: 107. <https://doi.org/10.3390/economies11040107>

Received: 7 March 2023

Accepted: 21 March 2023

Published: 31 March 2023



**Copyright:** © 2023 by the author. Licensee MDPI, Basel, Switzerland. This article is an open access article distributed under the terms and conditions of the Creative Commons Attribution (CC BY) license (<https://creativecommons.org/licenses/by/4.0/>).

2020, denoting the largest drop in US history (Rubbiani et al. 2022). Moreover, during the early phases of the pandemic, investors experienced anxiety, dread, and panic because of the unforeseen health and economic prospects (Cervantes et al. 2022). According to Yu and Xiao (2023), the pessimistic news from COVID-19 government restriction policies generated more instability in stock markets than the optimistic news. Moreover, Chebbi et al. (2021) emphasized that COVID-19 has a negative relationship with stock liquidity, implying that the pandemic undermined business liquidity. In addition, Tiwari et al. (2022) confirmed that a causal connection occurred between the number of cases of COVID-19 infections and stock market liquidity.

While the pandemic has devastated the world's economy, it has been extremely detrimental to nations that export commodities with unpredictable pricing (Shehabi 2022). During the COVID-19 outbreak, oil prices plummeted dramatically in April 2020. For the first time in history, US crude futures dropped to negative values, falling from USD 18 a barrel to USD −38, as stockpiles overloaded storage capacity (Mensi et al. 2020).

Securities that behave independently to market events were preferred for minimizing risk in portfolios (Yildirim et al. 2022). Hence, investors looked up assets that hedge or serve as a safe haven against aggregate macroeconomic shocks as a consequence of economic turbulence (Kamal et al. 2022). Gold is regarded as a safe haven asset by investors who encounter unexpected price fluctuations in financial markets and inflation (Bani-Khalaf and Taspinar 2022). When COVID-19 started to spread, gold prices slowly declined, but began to increase again in February 2020. Gold surged against all major currencies, achieving a record high of USD 2063.19 per ounce in August 2020, its highest level in almost a decade (Li et al. 2022). Additionally, over the last few years, the priority has shifted from gold to a new asset referred to as Bitcoin. Bitcoin was initially proposed in 2009, after the collapse of the investment bank Lehman Brothers, as confidence in financial institutions plummeted (Chemkha et al. 2021). Bitcoin's price increased sharply, and its closing price first surpassed USD 60,000 on 13 March 2021, before dropping to roughly USD 30,000 in July 2021 (Elsayed et al. 2022). Hence, Conlon and McGee (2020) raised suspicions on Bitcoin's potential to provide protection from volatility in conventional markets. Furthermore, Salisu and Ogbonna (2022) proved that the volatility of cryptocurrency returns was higher during the coronavirus outbreak than it was during preceding financial crises, such as the global financial crisis.

Financial shocks may propagate across nations and markets because of the swift pace of the globalization process, and the turmoil will heighten the likelihood of financial instability or alter the contagion structure among various markets (Guo et al. 2021). For instance, Liu et al. (2022) proved that risk spillovers from European and American equity markets substantially increased, but those from Asian markets obviously decreased after the onset of the COVID-19 pandemic. In addition, Banerjee (2021) stressed a major financial contagion in most developed and emerging nations with extensive trade ties with China during the COVID-19 episode.

This book comprises 17 papers published in the Special Issue entitled "The Impact of COVID-19 on Financial Markets and the Real Economy", centered on exploring variations in the structure of socioeconomic models due to the pandemic (Vasin 2022); the impact of the COVID-19 pandemic on the economy or industries of various nations such as Canada (Singh et al. 2022), China (Habibi et al. 2022), Slovakia (Svabova et al. 2022), United States (Rodousakis and Soklis 2022), or Vietnam (Huynh et al. 2021; Nguyen et al. 2022); workforce disruptions caused by the pandemic in the Philippines (Santos et al. 2022) or on the Russian labor market (Rodionov et al. 2022); examining the tourism and recreational potential of the cross-border regions of Russia and Kazakhstan, and the risks these regions faced during the COVID-19 phase (Tanina et al. 2022); analyzing the factors affecting young Vietnamese people's intentions to use financial technology (Khuong et al. 2022) or the factors affecting Vietnamese informal laborers' credit access in the context of the pandemic (Vu and Ho 2022); predicting Jordanian insurance companies and their performance examination (Altawwneh et al. 2022) or developing an early warning of solvency risk in the banking industry in

Indonesia during the COVID-19 outbreak (Hidayat et al. 2022); stock market responses during the COVID-19's several phases (Keliuotyte-Staniulieniene and Kviklis 2022); the drivers of cross-border mergers and acquisitions during the pandemic (Lee et al. 2021); and the financial and fiscal variables of the Ecuadorian economic groups (Tulcanaza-Prieto and Morocho-Cayamcela 2021).

Finally, the publications featured in this Special Issue expanded our comprehension surrounding the effect of the COVID-19 pandemic on financial markets and the real economy, and they proposed appealing future research avenues.

**Conflicts of Interest:** The author declares no conflict of interest.

## References

- Altarawneh, Ghada A., Ahmad B. Hassanat, Ahmad S. Tarawneh, Ahmad Abadleh, Malek Alrashidi, and Mansoor Alghamdi. 2022. Stock Price Forecasting for Jordan Insurance Companies Amid the COVID-19 Pandemic Utilizing Off-the-Shelf Technical Analysis Methods. *Economics* 10: 43. [CrossRef]
- Banerjee, Ameet Kumar. 2021. Futures market and the contagion effect of COVID-19 syndrome. *Finance Research Letters* 43: 102018. [CrossRef] [PubMed]
- Bani-Khalaf, Omar, and Nigar Taspinar. 2022. Oil and gold return spillover and stock market elasticity during COVID-19 pandemic: A comparative study between the stock markets of oil-exporting countries and oil-importing countries in the Middle East. *Resources Policy* 79: 102935. [CrossRef] [PubMed]
- Bouteska, Ahmed, Taimur Sharif, and Mohammad Zoynul Abedin. 2023. COVID-19 and stock returns: Evidence from the Markov switching dependence approach. *Research in International Business and Finance* 64: 101882. [CrossRef]
- Cervantes, Paula, Antonio Diaz, Carlos Esparcia, and Diego Huélamo. 2022. The impact of COVID-19 induced panic on stock market returns: A two-year experience. *Economic Analysis and Policy* 76: 1075–97. [CrossRef]
- Chebbi, Kaouther, Mohammed Abdullah Ammer, and Affan Hameed. 2021. The COVID-19 pandemic and stock liquidity: Evidence from S&P 500. *The Quarterly Review of Economics and Finance* 81: 134–42. [CrossRef]
- Chemkha, Rahma, Ahmed BenSaida, Ahmed Ghorbel, and Tahar Tayachi. 2021. Hedge and safe haven properties during COVID-19: Evidence from Bitcoin and gold. *The Quarterly Review of Economics and Finance* 82: 71–85. [CrossRef]
- Conlon, Thomas, and Richard McGee. 2020. Safe haven or risky hazard? Bitcoin during the Covid-19 bear market. *Finance Research Letters* 35: 101607. [CrossRef]
- Costola, Michele, Oliver Hinz, Michael Nofer, and Loriana Pelizzon. 2023. Machine learning sentiment analysis, COVID-19 news and stock market reactions. *Research in International Business and Finance* 64: 101881. [CrossRef]
- Dong, Zibing, Yanshuang Li, Xintian Zhuang, and Jian Wang. 2022. Impacts of COVID-19 on global stock sectors: Evidence from time-varying connectedness and asymmetric nexus analysis. *The North American Journal of Economics and Finance* 62: 101753. [CrossRef]
- Elsayed, Ahmed H., Giray Gozgor, and Chi Keung Marco Lau. 2022. Risk transmissions between bitcoin and traditional financial assets during the COVID-19 era: The role of global uncertainties. *International Review of Financial Analysis* 81: 102069. [CrossRef]
- Guo, Xiaochun, Fengbin Lu, and Yunjie Wei. 2021. Capture the contagion network of bitcoin—Evidence from pre and mid COVID-19. *Research in International Business and Finance* 58: 101484. [CrossRef] [PubMed]
- Guven, Murat, Basak Cetinguc, Bulent Guloglu, and Fethi Calisir. 2022. The effects of daily growth in COVID-19 deaths, cases, and governments' response policies on stock markets of emerging economies. *Research in International Business and Finance* 61: 101659. [CrossRef] [PubMed]
- Habibi, Zohal, Hamed Habibi, and Mohammad Aqa Mohammadi. 2022. The Potential Impact of COVID-19 on the Chinese GDP, Trade, and Economy. *Economics* 10: 73. [CrossRef]
- Hidayat, Taufiq, Dian Masyita, Sulaeman Rahman Nidar, Fauzan Ahmad, and Muhammad Adrissa Nur Syarif. 2022. Early Warning Early Action for the Banking Solvency Risk in the COVID-19 Pandemic Era: A Case Study of Indonesia. *Economics* 10: 6. [CrossRef]
- Hsu, Yu-Lin, and Leilei Tang. 2022. Effects of investor sentiment and country governance on unexpected conditional volatility during the COVID-19 pandemic: Evidence from global stock markets. *International Review of Financial Analysis* 82: 102186. [CrossRef]
- Huynh, Da Van, Thuy Thi Kim Truong, Long Hai Duong, Nhan Trong Nguyen, Giang Vu Huong Dao, and Canh Ngoc Dao. 2021. The COVID-19 Pandemic and Its Impacts on Tourism Business in a Developing City: Insight from Vietnam. *Economics* 9: 172. [CrossRef]
- Iyke, Bernard Njindan, and M. M. J. D. Maheepala. 2022. Conventional monetary policy, COVID-19, and stock markets in emerging economies. *Pacific-Basin Finance Journal* 76: 101883. [CrossRef]
- Jin, Lifu, Bo Zheng, Jiahao Ma, Jiu Zhang, Long Xiong, Xiongfei Jiang, and Jiangcheng Li. 2022. Empirical study and model simulation of global stock market dynamics during COVID-19. *Chaos, Solitons & Fractals* 159: 112138. [CrossRef]
- Kamal, Javed Bin, Mark Wohar, and Khaled Bin Kamal. 2022. Do gold, oil, equities, and currencies hedge economic policy uncertainty and geopolitical risks during covid crisis? *Resources Policy* 78: 102920. [CrossRef]

- Keliuotyte-Staniulieniene, Greta, and Julius Kviklis. 2022. Stock Market Reactions during Different Phases of the COVID-19 Pandemic: Cases of Italy and Spain. *Economies* 10: 3. [\[CrossRef\]](#)
- Khuong, Nguyen Vinh, Nguyen Thi Thanh Phuong, Nguyen Thanh Liem, Cao Thi Mien Thuy, and Tran Hung Son. 2022. Factors Affecting the Intention to Use Financial Technology among Vietnamese Youth: Research in the Time of COVID-19 and Beyond. *Economies* 10: 57. [\[CrossRef\]](#)
- Lee, Han-Sol, Ekaterina A. Degtereva, and Alexander M. Zobov. 2021. The Impact of the COVID-19 Pandemic on Cross-Border Mergers and Acquisitions' Determinants: New Empirical Evidence from Quasi-Poisson and Negative Binomial Regression Models. *Economies* 9: 184. [\[CrossRef\]](#)
- Li, Sufang, Qiufan Xu, Yixue Lv, and Di Yuan. 2022. Public attention, oil and gold markets during the COVID-19: Evidence from time-frequency analysis. *Resources Policy* 78: 102868. [\[CrossRef\]](#) [\[PubMed\]](#)
- Liu, Yuntong, Yu Wei, Qian Wang, and Yi Liu. 2022. International stock market risk contagion during the COVID-19 pandemic. *Finance Research Letters* 45: 102145. [\[CrossRef\]](#)
- Liu, Zhifeng, Toan Luu Duc Huynh, and Peng-Fei Dai. 2021. The impact of COVID-19 on the stock market crash risk in China. *Research in International Business and Finance* 57: 101419. [\[CrossRef\]](#)
- Martins, António Miguel, and Susana Cró. 2022. Airline stock markets reaction to the COVID-19 outbreak and vaccines: An event study. *Journal of Air Transport Management* 105: 102281. [\[CrossRef\]](#)
- Mensi, Walid, Ahmet Sensoy, Xuan Vinh Vo, and Sang Hoon Kang. 2020. Impact of COVID-19 outbreak on asymmetric multifractality of gold and oil prices. *Resources Policy* 69: 101829. [\[CrossRef\]](#)
- Nguyen, Trung Duc, Anh Hoang Le, Eleftherios I. Thalassinos, and Lanh Kim Trieu. 2022. The Impact of the COVID-19 Pandemic on Economic Growth and Monetary Policy: An Analysis from the DSGE Model in Vietnam. *Economies* 10: 159. [\[CrossRef\]](#)
- Rodionov, Dmitriy, Anastasia Ivanova, Olga Konnikova, and Evgenii Konnikov. 2022. Impact of COVID-19 on the Russian Labor Market: Comparative Analysis of the Physical and Informational Spread of the Coronavirus. *Economies* 10: 136. [\[CrossRef\]](#)
- Rodousakis, Nikolaos, and George Soklis. 2022. The Impact of COVID-19 on the US Economy: The Multiplier Effects of Tourism. *Economies* 10: 2. [\[CrossRef\]](#)
- Rubbaniy, Ghulame, Ali Awais Khalid, Konstantinos Syriopoulos, and Aristeidis Samitas. 2022. Safe-haven properties of soft commodities during times of Covid-19. *Journal of Commodity Markets* 27: 100223. [\[CrossRef\]](#)
- Salisu, Afees A., and Ahamuefula E. Ogbonna. 2022. The return volatility of cryptocurrencies during the COVID-19 pandemic: Assessing the news effect. *Global Finance Journal* 54: 100641. [\[CrossRef\]](#)
- Santos, Joost R., John Frederick D. Tapia, Albert Lamberte, Christine Alyssa Solis, Raymond R. Tan, Kathleen B. Aviso, and Krista Danielle S. Yu. 2022. Uncertainty Analysis of Business Interruption Losses in the Philippines Due to the COVID-19 Pandemic. *Economies* 10: 202. [\[CrossRef\]](#)
- Sariyer, Gorkem, Serpil Kahraman, Mert Erkan Sözen, and Mustafa Gokalp Ataman. 2023. Fiscal responses to COVID-19 outbreak for healthy economies: Modelling with big data analytics. *Structural Change and Economic Dynamics* 64: 191–98. [\[CrossRef\]](#)
- Shehabi, Manal. 2022. Modeling long-term impacts of the COVID-19 pandemic and oil price declines on Gulf oil economies. *Economic Modelling* 112: 105849. [\[CrossRef\]](#)
- Singh, Vikkram, Homayoun Shirazi, and Jessica Turetken. 2022. The COVID-19 Era&mdash;Influencers of Uneven Sector Performance: A Canadian Perspective. *Economies* 10: 40.
- Svabova, Lucia, Katarina Kramarova, and Dominika Chabadova. 2022. Impact of the COVID-19 Pandemic on the Business Environment in Slovakia. *Economies* 10: 244. [\[CrossRef\]](#)
- Tanina, Anna, Larissa Tashenova, Yevgeni Konyshv, Dinara Mamrayeva, and Dmitriy Rodionov. 2022. The Tourist and Recreational Potential of Cross-Border Regions of Russia and Kazakhstan during the COVID-19 Pandemic: Estimation of the Current State and Possible Risks. *Economies* 10: 201. [\[CrossRef\]](#)
- Tiwari, Aviral Kumar, Emmanuel Joel Aikins Abakah, Nana Kwasi Karikari, and Luis Alberiko Gil-Alana. 2022. The outbreak of COVID-19 and stock market liquidity: Evidence from emerging and developed equity markets. *The North American Journal of Economics and Finance* 62: 101735. [\[CrossRef\]](#)
- To, Bao Cong Nguyen, Bao Khac Quoc Nguyen, and Tam Van Thien Nguyen. 2023. When the market got the first dose: Stock volatility and vaccination campaign in COVID-19 period. *Heliyon* 9: e12809. [\[CrossRef\]](#) [\[PubMed\]](#)
- Tortorella, Guilherme Luz, Gopalakrishnan Narayanamurthy, Vijaya Sunder M, and Paulo A. Cauchick-Miguel. 2021. Operations Management teaching practices and information technologies adoption in emerging economies during COVID-19 outbreak. *Technological Forecasting and Social Change* 171: 120996. [\[CrossRef\]](#) [\[PubMed\]](#)
- Tulcanaza-Prieto, Ana Belén, and Manuel Eugenio Morocho-Cayamcela. 2021. The Evolution and Takeoff of the Ecuadorian Economic Groups. *Economies* 9: 188. [\[CrossRef\]](#)
- Uddin, Gazi Salah, Muhammad Yahya, Gour Gobinda Goswami, Brian Lucey, and Ali Ahmed. 2022. Stock market contagion during the COVID-19 pandemic in emerging economies. *International Review of Economics & Finance* 79: 302–9. [\[CrossRef\]](#)
- Vasin, Sergey Mikhailovich. 2022. Comparative Analysis of Socioeconomic Models in COVID-19 Pandemic. *Economies* 10: 278. [\[CrossRef\]](#)
- Vu, Hung Van, and Huong Ho. 2022. Analysis of Factors Influencing Credit Access of Vietnamese Informal Labors in the Time of COVID-19 Pandemic. *Economies* 10: 8. [\[CrossRef\]](#)

- Yarovaya, Larisa, Roman Matkovskyy, and Akanksha Jalan. 2021. The effects of a “black swan” event (COVID-19) on herding behavior in cryptocurrency markets. *Journal of International Financial Markets, Institutions and Money* 75: 101321. [[CrossRef](#)]
- Yıldırım, Durmuş Çağrı, Ömer Esen, and Hasan Murat Ertuğrul. 2022. Impact of the COVID-19 pandemic on return and risk transmission between oil and precious metals: Evidence from DCC-GARCH model. *Resources Policy* 79: 102939. [[CrossRef](#)]
- Yu, Xiaoling, and Kaitian Xiao. 2023. COVID-19 Government restriction policy, COVID-19 vaccination and stock markets: Evidence from a global perspective. *Finance Research Letters*: 103669. [[CrossRef](#)]
- Zhang, Yi, Long Zhou, Yajiao Chen, and Fang Liu. 2022. The contagion effect of jump risk across Asian stock markets during the Covid-19 pandemic. *The North American Journal of Economics and Finance* 61: 101688. [[CrossRef](#)]
- Zhong, Meihui, and Mingwei Lin. 2022. Bibliometric analysis for economy in COVID-19 pandemic. *Heliyon* 8: e10757. [[CrossRef](#)]

**Disclaimer/Publisher’s Note:** The statements, opinions and data contained in all publications are solely those of the individual author(s) and contributor(s) and not of MDPI and/or the editor(s). MDPI and/or the editor(s) disclaim responsibility for any injury to people or property resulting from any ideas, methods, instructions or products referred to in the content.



## Article

# The COVID-19 Pandemic and Its Impacts on Tourism Business in a Developing City: Insight from Vietnam

Da Van Huynh <sup>1,\*</sup>, Thuy Thi Kim Truong <sup>1</sup>, Long Hai Duong <sup>1,2,\*</sup>, Nhan Trong Nguyen <sup>1</sup>, Giang Vu Huong Dao <sup>1</sup> and Canh Ngoc Dao <sup>1</sup>

<sup>1</sup> School of Social Sciences and Humanities, Can Tho University, Can Tho 900000, Vietnam; kimthuy@ctu.edu.vn (T.T.K.T.); trongnhan@ctu.edu.vn (N.T.N.); daovhgiang@gmail.com (G.V.H.D.); dncanh@ctu.edu.vn (C.N.D.)

<sup>2</sup> Department of Global Hospitality and Tourism, Kyung Hee University, Seoul 02447, Korea

\* Correspondence: hvda@ctu.edu.vn (D.V.H.); long.7032450@gmail.com (L.H.D.)

**Abstract:** The COVID-19 pandemic has generally destroyed the global tourism industry and threatened the recovery of destinations in developing countries facing more challenges from increasingly serious waves of the pandemic. Although many studies have attempted to measure the general impacts of COVID-19, very little research has been conducted to assess its overall impact on specific tourism destinations throughout many waves of the pandemic. This research aims to explore how a tourism economy in a developing country context has been damaged after many waves of COVID-19. A typical emerging city in Vietnam experiencing three waves of the COVID-19 pandemic was selected as a case study. The study recruited 40 representatives of tourism-related organizations for in-depth interviews, while 280 questionnaires were distributed to participants from different tourism organizations. The findings indicate that the majority of tourism businesses in the examined case study seriously suffered from the pandemic, and very few tourism-related enterprises were able to recover after the first wave of infection. Unfortunately, the tourism business sectors were found to be on the brink of bankruptcy or facing permanent shutdown after the third wave. All tourism enterprises generally appeared to experience a sharp drop in the number of customers, tourism revenue, service facilities and exploitation, as well as employee downsizing, but the degree of downturn differed among the examined enterprises. Among the tourism enterprises, travel agencies and the accommodation sector were found to suffer the greatest economic losses compared to other stakeholders. In general, the COVID-19 pandemic's impact on the tourism business in Vietnam is a big concern, which may require a timely economic policy response and financial scheme to better support local enterprises in coping with the challenges during post-pandemic recovery.

**Keywords:** COVID-19; pandemic; tourism; impact; Vietnam

**Citation:** Huynh, Da Van, Thuy Thi Kim Truong, Long Hai Duong, Nhan Trong Nguyen, Giang Vu Huong Dao, and Canh Ngoc Dao. 2021. The COVID-19 Pandemic and Its Impacts on Tourism Business in a Developing City: Insight from Vietnam. *Economics* 9: 172. <https://doi.org/10.3390/economics9040172>

Academic Editor: Ștefan Cristian Gherghina

Received: 11 October 2021  
Accepted: 26 October 2021  
Published: 5 November 2021

**Publisher's Note:** MDPI stays neutral with regard to jurisdictional claims in published maps and institutional affiliations.



**Copyright:** © 2021 by the authors. Licensee MDPI, Basel, Switzerland. This article is an open access article distributed under the terms and conditions of the Creative Commons Attribution (CC BY) license (<https://creativecommons.org/licenses/by/4.0/>).

## 1. Introduction

Tourism generates huge revenue for destinations and contributes to overall economic development for a plethora of countries, especially tourism-dependent nations. In other words, there is a strong link between tourism development and economic growth, which also stimulates the development of other related businesses in a country (Haryanto 2020). However, tourism is a vulnerable industry which may crash due to potential risks such as global pandemics (Shakya 2009). The COVID-19 pandemic has inflicted serious and widespread impacts on a wide range of economic sectors, particularly the tourism industry. This is likely true for countries where the economy mainly depends on tourism, where businesses face much bigger challenges for economy resilience in both the short and long term. An abundance of consequences, including regional to national lockdowns, as well as the suspension or cancellation of tourism- and hospitality-related services, have increasingly occurred on the global scale. A typical comparison is that the COVID-19 pandemic has been estimated to be nine times more devastating than the impact of the



September 11 crisis; the economic revenue loss was enormous, at around USD 124 billion in 2020 alone (Haryanto 2020; Sarkodie and Owusu 2021). Unfortunately, the profound and long-lasting impacts of the COVID-19 pandemic may damage global economies, especially businesses in developing countries where the economy depends on tourism, and where the level of tourism resilience after pandemics is limited (Ismael et al. 2021).

In Vietnam, the COVID-19 pandemic and its impact on the tourism industry are major concerns due to multiple lockdowns imposed since 2020. The first case of COVID-19 infection in Vietnam was detected on 23 January 2020. Tourism activities in Vietnam in general and Can Tho city in particular fell into a state of crisis and almost total paralysis until March 2021. Most of the services and activities associated with tourism and hospitality were stopped or interrupted, which led to devastating consequences, including a loss of revenue for the tourism industry and a loss of jobs for workers. From June 2020, the domestic tourism industry started to recover; however, with the impact of the second and third waves of COVID-19, the situation once again became a struggle, with a difficult economic recovery from the pandemic anticipated. According to the International Monetary Fund (IMF), some economic sectors in Vietnam were projected to be severely affected, especially tourism, transportation and accommodation services. According to the annual estimated statistics, Can Tho's tourism industry generates a value of nearly VND 4500 billion and creates jobs for nearly 40,000 people. Following multiple lockdowns, the recovery of the city's tourism industry remains in a difficult and ineffective state due to the lack of a scientific basis to accurately assess the current situation and propose proper recovery solutions.

To some extent, the timely policies and supportive measures have contributed to the alleviation of the impact of the pandemic and the prevention of mass bankruptcy for local businesses. Therefore, it is essential and urgent for the tourism industry in Can Tho city to assess the current status of COVID-19's impact and find proper solutions for post-crisis recovery. As such, this research aimed to explore how the COVID-19 pandemic has influenced the tourism industry in Can Tho city, and identify the key tourism sectors and the degree to which local tourism businesses have suffered from waves of the pandemic. Therefore, the purpose of this study was to examine two research questions: (1) How hard has the COVID-19 pandemic hit the tourism industry in a developing city in Vietnam? and (2) How vulnerable are the local tourism enterprises in response to the pandemic's impacts?

## 2. Literature Review

This section reviews key studies regarding the economic impact of the COVID-19 pandemic on the tourism industry on a global scale, particularly reflecting on current research in Vietnam to provide a better understanding of how tourism businesses in a developing country context have suffered economically from the lingering pandemic crisis period.

The hospitality sector across different regions of the world has also suffered enormously due to the pandemic. Nguyen (2020) claimed that large hospitality enterprises are likely to be more resilient to the effects of the pandemic. This means that small businesses are at disadvantage, facing a risk of shutdown or even bankruptcy. In addition, the aviation sector has been vulnerable to the pandemic, with continuous lockdowns and flight restrictions leading to airline bankruptcies on a global scale (Dube et al. 2021). This has been evidenced by large airlines around the world facing bankruptcy and uncertainties as a result of the pandemic (Gole et al. 2021). Furthermore, the accommodation sector has been affected by the COVID-19 pandemic, whereby "new normal" measures have resulted in hotels adapting to maintain their business (Krouk and Almeida 2021). Lastly, tourist attractions have faced challenges with the potential scenario of shutdowns following repetitive waves of the COVID-19 pandemic (Prihadi et al. 2021).

The World Health Organization (WHO) officially declared COVID-19 a pandemic on the 11th of March 2020. The pandemic was projected to cause a wide range of socio-cultural,

political and economic impacts (Sigala 2020). Obviously, the global tourism industry is highly vulnerable to such crises, and the impacts on the global tourism destinations will be profound and long-lasting (Rassy and Smith 2013). Evidently, the significant 78% decrease in the global tourist arrivals rate and loss of around 120 million jobs were accounted to lead to a loss of USD 1.2 trillion in export revenues (Sigala 2020; UNWTO 2020). This indicates that global economic losses due to the pandemic are enormous, but particularly in destinations whose economy system mainly depends on tourism businesses.

According to Ulak (2020), global mobility has spread the pandemic to all countries and the tourism intention among the global tourists has dropped significantly for safety- and health-related reasons. Hoque et al. (2020) found that tourists were generally cautious when making trips during outbreaks of the pandemic. More seriously, the authors reported that psychological impacts of the pandemic on tourist's travel intentions and experiences during the crisis were a major concern. Similarly, other studies also highlighted the negative impacts of the COVID-19 pandemic on different sectors of the tourism and hospitality industries across different countries.

The tourism industry in Asia has also suffered enormously during the initial hits of the COVID-19 pandemic. More specifically, unemployment, bankruptcy, revenue loss and budget deficits are common serious consequences brought about by the COVID-19 pandemic (Kasare 2020). In the Philippines, the impact of COVID-19 on the national tourism business was estimated to represent a loss of more than USD seven billion as the pandemic crisis persisted until July 2020 (Centeno and Marquez 2020). More seriously, the research of Bakar and Rosbi (2020) also predicted that global tourism might collapse under the impact of COVID-19 if there were no suitable measures implemented. Recently, there have been a number of publications dealing with global tourism prospects in the post-COVID-19 period. According to Chang et al. (2020), there should be a critical transformation of global sustainable tourism development in order to better recover in post-COVID-19 crisis challenges. Higgins-Desbiolles (2020) proposed the empowerment of local tourism communities, which could be seen as an important transformation moving towards sustainable development.

Cheer (2020) further suggested a concept called "human flourishing", which offers a potential approach to alleviate the pandemic impact on tourism communities and requires current tourism development in a more sustainable transformation. On the 6th of August 2020, the *Journal of Sustainable Tourism* announced an article titled "The war of over tourism" that stressed the challenges to sustainable tourism in the tourism academy after COVID-19 (Higgins-Desbiolles 2020). This report analyzes the challenges faced by academia and the global tourism industry in the post-COVID-19 era. Thus, it can be seen that there is increasingly attention paid among tourism scholars to the impact of the COVID-19 crisis, because this global pandemic may cause long-term consequences, given that the pandemic and responses to it remain ongoing and dynamic. Therefore, it is critical to have a general assessment of the pandemic impacts on different sectors and businesses of a tourism destination, which facilitates a more effective resilience approach.

The impact of COVID-19 on the tourism industry in Vietnam is currently a major concern, because the crisis has entailed a wide range of economic downturn and profound effects on the livelihood of citizens. According to Quang et al. (2020), Vietnam is one of the top 10 fastest growing tourism industries globally, although tourist arrivals sharply dropped by around 22% in early February 2020. More specifically, tourism business revenue fell sharply during just the first 3 months of 2020, representing a VND 143.6 billion loss, because all tourism activities are inter-related (Phạm et al. 2020). In terms of job loss, it is estimated that around 98% of workers in Vietnam's tourism-related businesses left their jobs because of the pandemic (Quang et al. 2020; Tô and Bui 2020). The authors also indicated that the rate of tourism business suspension or shutdown were increasingly popular among medium and small businesses, especially.

Lê Kim Anh (2020a) and Tô and Bui (2020) conducted a statistical analysis of the impacts of COVID-19 on Vietnam's tourism industry, including reductions in international

tourist arrival, accommodation establishment closures, increasing unemployment and declining tourism revenue. The authors have proposed key measures targeting expanding marketing, supporting businesses and simplifying immigration procedures. According to analysis from the University of Economics and Finance, the best scenario was that Vietnamese tourism could recover in a 'V-shape', which means a sharp drop and then bouncing back immediately, equivalent to the original decline, or a 'U-shape', depending on the speed of control and economic recovery on the national and global scale. The statistics indicated that the Vietnamese domestic tourism market has recovered first, followed by the Chinese tourist market, Asian tourist arrivals and finally the Western industry. However, many initial articles in newspapers including the Vietnam Communist Party (*Trường Đại học Kinh Tế Quốc Dân (Đ.H) 2020*), Nhân Dân (*Anh 2020b*), Vietnam Pictorial (*TTXVN/VNP 2020*) and by researchers (*Giang et al. 2020; Long and Uyên 2020; Thang 2020*) have raised attention about the impact of COVID-19 on the tourism business; some recent papers (*Ngoc Su et al. 2021; Tri 2021*) have pointed out some practical solutions to revitalize the tourism industry in Vietnam. In spite of the increasing concern among tourism scholars in Vietnam, there has been a lack of systematic and in-depth analyses exploring the overall impact of the pandemic on the tourism industry across different tourism sectors of a tourism destination. Thus, this study aims to provide an insight into the total impact of COVID-19 on the tourism industry by employing both secondary data and primary qualitative data collection to reflect the current problems facing tourism stakeholders in Vietnam. These sources of data used as the basis for systematic and in-depth analysis in this study will be further discussed in the next section.

### 3. Research Setting

Can Tho is one of the five cities directly under the Central Government of Vietnam and is the most modern and developed city in the Mekong Delta region of Vietnam. At the same time, it plays a role as a socio-economic, cultural, medical, educational and commercial center of the southwestern region. This city encompasses a large area of 1400 km<sup>2</sup>, with nine districts and a total population of around 1.3 million people. Can Tho converges many favorable factors for successful development of the tourism industry. Geographically, it is located in a traffic hub linking the provinces in the region. Can Tho has various tourism resource advantages, ranging from natural to man-made tourism assets, which enables this destination to deliver a wide range of tourism experiences to both domestic and international tourists.

Before the pandemic, Can Tho city has welcomed more than 8.8 million visitors, earning more than VND 4435 billion, which contributed nearly 5% of the city's GDP (*Ái Lam 2020*). The development of tourism in Can Tho city created jobs for 39,300 workers in 2019, of which the numbers of on-duty workers and indirect employees made up 13,100 and 26,200, respectively. To meet the tourism needs prior to COVID-19, Can Tho city had established more than 200 restaurants and catering establishments, 275 tourist accommodation establishments, 22 family-own tourist attractions, 19 home-stays and 59 international and domestic travel businesses. Before COVID-19, the tourism industry of Can Tho city aimed to perform many tasks and solutions to develop the local tourism industry into a key economic sector of the locality. In this regard, the tourism industry attempted to establish an attractive destination image by improving the tourism infrastructure and diversifying the hospitality businesses related to accommodation, dining establishment, sightseeing, tour guiding and so on.

Unfortunately, the ongoing waves of the COVID-19 pandemic have led to collapse of many different sectors of the local tourism system. First and foremost, the manifestation was the decrease in the number of customers for tourism service businesses. According to the statistics, the local tourism enterprises had faced a significant decrease in the number of customers from 30 to 380,000 people, with an average of 11,234.4 people. In terms of relative value, the proportion of customers with the lowest, highest and average decrease was 10%, 100%, and 62.3%, respectively. The decline in the number of customers has led to

a drop in the revenue of tourism service businesses in absolute and relative values. In terms of absolute value, the revenue of businesses has decreased by at least VND 1.3 million and a maximum of VND 102 billion. In terms of relative value, the lowest decline in corporate revenue was 15%, whereas the highest constituted a 100% loss, and the average was 61.3%. The customer reduction also meant a decrease in the capacity of using assets and tourism services, which were reported to fluctuate from by least 5% to 100% (see Table 1). The decline in the number of customers also caused the loss of jobs of current employees in the tourism industry because all local businesses have had to downsize human resources to minimize expenses. As a result, it was estimated that the number of employees in each tourism enterprise who were laid off was at least 1, or could have been up to 70 during the COVID-19 pandemic crisis.

**Table 1.** Impacts of the COVID-19 pandemic on tourism in Can Tho city.

Indicator/Item	Average Decline (Absolute Number)	Average Decline (Relative Proportion)
Customers	11,234.4 people	62.3%
Revenue	VND 2.6 billion	61.3%
Capacity of exploitation/use of property/tourism services	-	57.4%
Reduction in employees	9.3	50.3%

(Source: Enterprise manager interview data in Can Tho city, 2020).

According to Nguyễn Tuấn (2020), it was estimated that tourists to Can Tho city in 2020 would reach 5,605,865 arrivals, down 36.8% over the same period, reaching 60.9% of the year plan. Accommodation tourists numbered 2,020,145 arrivals, down 32.8% over the same period in 2019, reaching 61.4% of the year plan. In particular, international visitors were estimated to constitute 111,420 arrivals, down 72.7% over the same period in 2019, reaching 25.3% of the year plan. Domestic tourists numbered 1,908,725 arrivals, down 26.5% over the same period in 2019, reaching 67% of the year plan. Outbound tourism packages were provided for 5550 tourists to travel abroad, down 77.6% over the same period in 2019, reaching 20.6% of the year plan. Total revenue from tourism was estimated at more than VND 3169 billion, down 28.6% over the same period in 2019, reaching 62.1% of the year plan. According to Ái Ái Lam (2021), in 2020, about 45.9% of direct workers in Can Tho city were forced to leave their jobs in the tourism sector due to the impact of the COVID-19 pandemic. In spite of the highly expected 2020 tourism targets, the first wave of COVID-19 caused a huge decline in the number of international visitors, while the following waves of COVID-19 placed the local tourism industry under much greater pressure.

#### 4. Research Methods

Mixed methods can be used as an effective tool in social science research to increase the validity of research findings and meet a particular purpose of tourism research (McKim 2017). McManamny et al. (2015) also identified a critical reason for the common use of mixed approaches for tourism research to overcome objective deficiencies of employing qualitative or quantitative methodologies alone. As such, a mixed method approach was employed in this study to collect both qualitative and quantitative data to meet the data collection objectives. More specifically, qualitative data allowed researchers to measure the impacts of COVID-19 on the tourism industry of the examined case study, whereas the qualitative data enabled the researchers to gain in-depth information regarding the stakeholder's perceptions and attitudes about the pandemic impacts on their business operations.

The research design included two main phases. The first stage began with developing a framework for qualitative data gathering, whereas the second stage focused on the quantitative data collection. This study adopted the theoretical framework of an impact evaluation model on tourism destination developed by Gertler et al. (2016) and

White (2009). Accordingly, the research team then developed a set of questions for the in-depth interviews, suitable for the research setting in Vietnam. A pilot study was conducted with tourism experts at Can Tho University to standardize the final interview questions. Potential participants for the interview were selected carefully by using a purposive sampling method. More specifically, the study recruited 16 representatives from tourism management organizations (e.g., tourism associations, Department of Culture, Sports and Tourism, centers for tourism development), 16 representatives of tourism-related organizations (e.g., Department of Information and Communications, Department of Health, Department of Planning and Investment, Department of Finance), and 8 representatives from local authorities in the city. Accordingly, the interviews were conducted from October to November 2020. For the second stage of data collection, the questionnaire was framed around the key emerging themes from the interviews which were relevant to the research setting. Then, the questionnaire was critically reviewed by the tourism experts at Can Tho University so that proper modification could be made to complete the official questionnaire. As a part of data collection triangulation, a pilot study with 20 tourists was conducted to test the validity and reliability of the measurement scale and content of the questions. The process of quantitative data collection lasted for 4 months, from December 2020 to March 2021.

Regarding the selection and recruitment of the participants, criteria were developed to choose a relevant list of potential participants who were tourism business managers. The first participant was chosen randomly from the list and the subsequent interviewees were recruited by using a snowball sampling method. In order to collect data regarding the impact of the COVID-19 pandemic on the tourism industry of Can Tho city, 280 tourism-related business managers were recruited. More specifically, the majority of respondents were in charge of managing accommodation (28.6%) and tourist attractions (25%), whereas 17.9% of respondents were from both travel agencies and dining establishments, followed by family-owned businesses and homestays with 10.7%. The sample compared to the population is presented in Table 2.

**Table 2.** Sample compared to population.

Item	Sample	Population (2018) a	Percentage (%)
Accommodations	80	275	29.1
Travel agencies	50	59	84.7
F & B establishments	50	200	25.0
Family-owned business and homestays	30	41	73.2
Tourist attractions	70	70	100

Source: (a) Data provided by the Department of Culture, Sports and Tourism of Can Tho City.

The questionnaire structure consisted of two parts. The first section gathered the respondents' demographic information, whereas the second part focused on exploring five key aspects: (1) the impact of the COVID-19 pandemic on local tourism business; (2) the measures to alleviate the impact and foster tourism business recovery during and after the pandemic; (3) the supportive policies of the local governments; (4) new business opportunities under the COVID-19 pandemic; and (5) corporate recommendations for the local tourism industry. The questionnaire mainly collected quantitative data by using different measurement techniques including multiple-choice questions, 5-point Likert scales (1, totally disagree; 5, totally agree) and open-ended questions to gather the qualitative data.

Regarding the process of data analysis and interpretation, the qualitative data were coded to identify popular themes and categories that are relevant to the research questions. The emerging themes were grouped using NVivo software. For quantitative data analysis, a total of 280 questionnaires were distributed and collected (response rate at 100%) and all the questionnaires were eligible for further analysis. Using IBM SPSS Statistics 20.0, data from the questionnaire were imported and analyzed to generate descriptive statistics and one-way analysis of variance (one-way ANOVA).

## 5. Research Findings

This section presents the key findings regarding the general impacts of the COVID-19 pandemic on the local tourism industry in Can Tho city, and particularly highlights the vulnerability of different types of local tourism-related businesses, and the collective responses from key stakeholders in coping with the pandemic.

### 5.1. How Serious Is It?

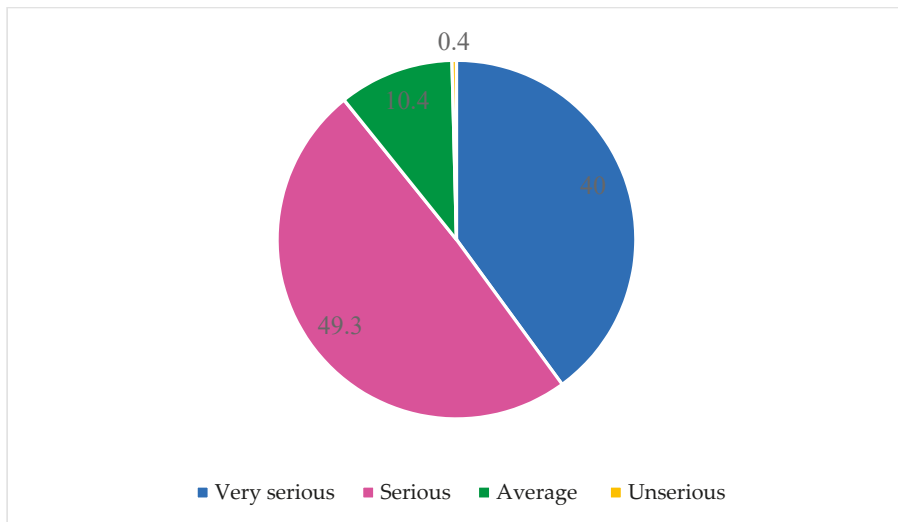
The COVID-19 pandemic has generally damaged the tourism industry in Can Tho city. The sharp decline in the number of customers, especially international visitors, has made many tourist service establishments close or suspend their business operations (Figure 1). Through the interviews with the representatives of the Department of Culture, Sports and Tourism of Can Tho City, about 20% of the tourism service businesses in the city and many tourism- and hospitality-related enterprises have had to close their businesses, which has also meant a huge loss in revenue (business, government, employees), loss of jobs, confusion and burden on society (businesses, employees) and negative impacts on local socio-economic development in both the short and long term (Figure 2).



**Figure 1.** Tourist attractions that stopped doing business during the COVID-19 pandemic. (Source: Photos taken by the research team, 2020).

The majority of the managers of tourism service businesses in this study believed that the COVID-19 pandemic has impacted local business either at a serious or very serious level, at 49.3% and 40%, respectively. According to the statistics, very few enterprises admitted that the COVID-19 pandemic has had moderate or non-serious impacts on their business, at 10.4% and 0.4%, respectively. This finding affirmed the serious impact of the pandemic on the tourism and hospitality industry (Panzone et al. 2021).

According to the data provided directly from the Department of Culture, Sports and Tourism of Can Tho City, the revenue of businesses has decreased significantly compared to the same period in 2019. More specifically, the revenue of accommodation establishments decreased on average from 50% to 90%, whereas the revenues of travel agencies and dining establishments decreased by 90% and around 60–90%, respectively.



**Figure 2.** The perceived impact of the COVID-19 pandemic on tourism service businesses in Can Tho. (Source: Enterprise manager interview data in Can Tho city, 2020).

The results of qualitative interviews with many stakeholders involved in the tourism business in Can Tho generally reflected their impuissant responses to the COVID-19 pandemic. The respondents stressed that the pandemic has caused a crisis in the tourism industry of Can Tho city, with extremely heavy losses. A representative of Can Tho City Tourism Association said:

*“The COVID-19 pandemic has had a great impact on the tourism industry of Can Tho city, especially the travel agencies, accommodations, and tourist destinations and transport services. Many tourism businesses were on the brink of bankruptcy, causing employees losing their jobs and creating a burden for the society”.*

In order to overcome difficulties during and after the pandemic, the findings from the survey indicated that all local business owners were aware of the importance of self-adjustment rather than dependence on the limited financial support from the government. Some common measures to deal with the pandemic consequences associated with renting premises, paying staff salaries and operating costs have been initiated. In this sense, a lot of companies chose to reduce staff numbers or close a part of their business temporarily, whereas the others adjusted their target markets and re-structured their tourism products or services. These are supposed to be temporary solutions for local businesses:

*“We could not just sit there and wait for the financial support from the local and central government. Although we were first passive at the first wave of pandemic, we are now proactive to prepare possible scenarios and have our own measures. Indeed, we are lucky not to close our business but not sure if lockdowns or another wave of COVID-19 occurs”.*

*(A representative of a tourism enterprise in Can Tho city)*

According to a representative of the Can Tho City Tourism Development Center, the COVID-19 pandemic has caused a domino effect in the entire tourism economy. As a result, a few surviving tourism enterprises have been unable to operate their business as usual due to a lack of other important suppliers.

*“A half of the businesses in the area were temporarily closed; some businesses operated moderately, over 70% of workers in the tourism industry were affected and unemployed... they had to change their jobs. It can be said that COVID-19 has been stifling the tourism industry, not only in Can Tho city but also nationwide.”*

According to the respondents, the domino effect of the pandemic crisis in Can Tho city almost froze its tourism economy, leading to devastating consequences. Evidently, around 63% of businesses in Can Tho city stopped operating; only 16% of businesses could remain open, but had to cut 14% of their operation scale and employees. On the other hand, with the consequences of the decline in customers and revenue, the remaining 7% of businesses had to dissolve when there was not enough funding to maintain operations. A representative of the local government of Cai Rang district projected a dark scenario for domestic tourism in the region:

*“COVID-19 has been and will continue to be a huge challenge for the tourism industry in Can Tho in particular and the entire tourism industry in our country in general”. This has caused a great pressure on the social economy when the laborers lost their jobs, the socioeconomic burden increased rapidly, and the job creation problem was under pressure. From that we can see the impact of the pandemic on the tourism industry and the economy. I think that the epidemic crisis is extremely serious.”*

## 5.2. COVID-19 Impact and the Vulnerability of Tourism Business Sectors

The research findings generally indicated differences in the impact of the COVID-19 pandemic on some tourism sectors and the types of tourism-related enterprises. Each type of tourism business with different business characteristics has been affected differently by the pandemic. According to the framework of this study, one of the key research objectives was to explore if there was any difference in the impact of the pandemic on business operations of the restaurants, accommodations, travel agencies, tourist destinations and family-owned tourist attractions. The results of data analysis by one-factor variance analysis showed that there was a statistically significant difference in the impact of the COVID-19 pandemic on some key business activities in terms of the percentage of customer decline, total decline, the proportion of revenue and the proportion of employee reduction (See Table 3).

**Table 3.** ANOVA results.

Item		df	F	p
Customer reduction	Between Groups	4	0.992	0.415
	Within Groups	102		
	Total	106		
Percentage of customer reduction	Between Groups	4	7.339	0.000
	Within Groups	274		
	Total	278		
Revenue reduction	Between Groups	4	2.466	0.052
	Within Groups	79		
	Total	83		
Percentage of revenue reduction	Between Groups	4	4.041	0.003
	Within Groups	257		
	Total	261		
Percentage of reduction in capacity of exploitation, property use and tourism services	Between Groups	4	1.665	0.158
	Within Groups	263		
	Total	267		
Number of employees to be laid off	Between Groups	4	1.737	0.146
	Within Groups	127		
	Total	131		
Percentage of employees to be laid off	Between Groups	4	11.133	0.000
	Within Groups	127		
	Total	131		

(Source: Enterprise manager interview data in Can Tho city, 2020).

According to Table 4, the COVID-19 pandemic has caused a decrease in the percentage of customers and the percentage of employees being laid off, differing from business to business. In terms of the proportion of customer decline, tourist fruit orchard houses were



the most affected (68.5%), followed by other tourist attractions (67.8%). The other types of tourism businesses with smaller decreases in the number of customers than travel agencies made up 65.8%, compared to accommodation establishments and dining establishments at 58.4% and 53.4%, respectively. Regarding the proportion of employees being laid off, large tourism sites and family owned-tourist attractions were the two organizations with the greatest proportion of employees being laid off at 74.3% and 63%, respectively. The other tourism-related businesses including accommodation, tour operators and dining establishment experienced similar impacts, at 46.4%, 39.5% and 39.2%, respectively.

**Table 4.** Differences of COVID-19 impacts on business performance of firms in Can Tho city.

Item		N	Mean
Percentage of customer reduction	Accommodation	80	58.4
	Travel agency	49	65.8
	Dining establishment	50	53.4
	Tourist attraction	70	67.8
	Tourism fruit orchard	30	68.5
Revenue reduction (VND millions)	Accommodation	20	2337.7
	Travel agency	13	11,336.9
	Dining establishment	9	1577.9
	Tourist attraction	30	263.2
	Tourism fruit orchard	12	240.5
Percentage of revenue reduction	Accommodation	80	58.3
	Travel agency	48	64.2
	Dining establishment	48	54.7
	Tourist attraction	63	66.5
	Tourism fruit orchard	23	65.3
Percentage of employees to be laid off	Accommodation	34	46.4
	Travel agency	20	39.5
	Dining establishment	40	39.2
	Tourist attraction	28	74.3
	Tourism fruit orchard	10	63.0

(Source: Data collected from interviewing tourism enterprises in Can Tho city, Vietnam, 2020).

The above findings generally indicate the decline in revenue for different types of businesses. Unexpectedly, tourist destinations and family-owned tourist attractions experienced the greatest decline in revenue at 66.5% and 65.3%, respectively. Meanwhile, 58.3% of accommodation establishments and 54.7% of food establishments witnessed a decrease in revenue. At 90% confidence, the revenue of different types of tourism business experienced different drops. The travel agencies, accommodation establishments, and food and beverage establishments were those with the greatest decrease in total revenue, at VND 11,336.9 million, VND 2337.9 million and VND 1577.9 million, respectively. Meanwhile, the tourist destinations and family-owned attractions saw relative declines in total revenue of VND 263.2 million and VND 240.5 million, respectively.

## 6. Discussion

This section addresses the research question by revisiting the significant findings and providing in-depth discussion regarding the overall impact of COVID-19 on the tourism industry, particularly highlighting how vulnerable local tourism businesses suffered from multiple waves of the pandemic.

### 6.1. Overall Impact of the Pandemic on the Local Tourism Industry

The COVID-19 pandemic generally caused a standstill of tourism development in developing cities in Vietnam during the first wave. The findings in this study indicated that this paralysis has resulted in a plethora of negative impacts on different sectors of the local tourism industry. The first wave of the pandemic placed local businesses under such intensive pressure. Nearly 90% of tourism-related businesses faced economic impacts at

serious or very serious levels, with 20% of tourism-related enterprises having to temporarily close their business. This implies that a tourism-dependent city might be under much more pressure because of the huge tourism revenue losses. The evidence from this research revealed increasing concerns of the temporary closure or shutdown of many different genres of tourism enterprises and suppliers due to the sharp drop of tourism demand, which has directly caused supply chain disruption of the whole tourism system. This also means that even surviving enterprises during the waves of the pandemic might find it difficult to recover their financial capabilities due to the limitations of local tourism business activities.

Evidently, local enterprises were found to face the increasing revenue losses, fluctuating around 50% to 90% depending on the types of tourism-related businesses. Of which, tourism enterprises were found to suffer the hardest hits, with nearly a 90% economic downturn during the initial waves of the pandemic. However, it was estimated that the real impact of the COVID-19 pandemic on the local tourism industry in this examined case study was even worse (Mekong Delta Tourism Association 2020). Similar research findings by Kuqi et al. (2021) also reconfirmed the tourism business crisis in Kosovo and the huge decline in tourism revenue compared to previous years. Other studies also reported a significant drop in tourist arrivals during the pandemic and their intentions not to travel post-pandemic (Terziyska and Dogramadjieva 2021). This reveals the serious effects of the pandemic on tourism demand at the global scale (Deyshappriya et al. 2021). In general, the pandemic has caused a plethora of significant impacts on different aspects of the local tourism economy and may contribute to a long-lasting crisis for the national tourism system which will be further discussed in the next section.

#### 6.2. Domino Effects of COVID-19 on the Local Tourism Industry

The impact of the COVID-19 crisis has led to a domino effect in different areas of the local tourism system. The findings in this research reflected the reality of the hardest hits to the local tourism enterprises, many of which were found to be on the edge of bankruptcy. This finding could be similar to that of the research by Wieprow and Gawlik (2021), which also confirmed that the pandemic crisis might entail the collapse of the tourism enterprises in Poland. The same is true for business bankruptcy on a large scale in Argentina due to lingering pandemic impacts (Korstanje 2021). This common phenomenon could be interpreted in many different ways. First of all, the long-lasting lockdowns during multiple waves of COVID-19 have affected all local businesses, especially small enterprises with limited financial capacity. As a result, the small business enterprises in this study were likely to face a possibility of real shutdown, and very few small-sized business enterprises were found to overcome the second wave of the pandemic. A study by Kalogiannidis (2020) also confirmed that small businesses might be at risk and face the practical possibility of bankruptcy due to long lockdowns. Moreover, even small businesses in European countries which benefited from their country's good financial schemes also faced financial crisis, and very few of them could survive repetitive and long-lasting lockdowns (García et al. 2020; Parikh 2020).

In addition, the domino effect also brought indirect consequences to other tourism-related business sectors when tourism demand experienced a free fall as a result of repetitive waves of the pandemic. The tourism managers in this study showed little optimism about post-crisis recovery because of supply chain disruption and the existing barriers. First of all, financial difficulty, which was found to be the most common concern among the tourism enterprises, necessitated better financial support from both local and central government. Evidently, Vietnam's tourism stimulus packages focused more on easing pandemic control restrictions and fostering the domestic demand marketing, whereas the financial measures were inefficiently addressed (Tri 2021). As such, the majority of the surviving tourism enterprises after multiple waves of the pandemic were likely unable to maintain temporary operation in the long run, whereas the medium- and small-sized enterprises had to face more challenges in coping with fiscal measure shortages during the ongoing pandemic. Bartik et al. (2020) suggested that small enterprises had to take their

own measures to overcome the challenges, although the researchers accepted the reality that financial policy responses from local levels might be limited to strengthen the survival ability of local businesses.

The other typical barrier to local business recovery is the governmental policy of quarantine. The tourism managers in this study claimed that any positive case of COVID-19 found at a local business might lead to a temporary shutdown of their business operation, and this influenced their recovery opportunities during the pandemic waves. According to [Masondo \(2021\)](#), the mass collapse of local businesses during the pandemic could be alleviated if the tourism businesses had effective preparation to be more resilient to the impacts and more flexible to adapt to the governmental policy of pandemic prevention and control. Similarly, the Vietnamese policy of pandemic prevention and control was found to have impacted the poor resilience of the local tourism industry in Can Tho, which will be discussed in-depth in the next section.

### 6.3. Poor Resilience to Pandemic Impacts

According to the majority of the research respondents, the governmental policy response to the pandemic might have strongly influenced local business operation and resilience. A lot of tourism enterprise managers explained that the slow and passive response to the pandemic from local and central governments might have contributed to the ineffective responses of the local businesses. This result reconfirmed the previous study by [Van Van Nguyen et al. \(2020\)](#), that Vietnam's central government had a slow response to the first wave of the COVID-19 pandemic, causing difficulties for the tourism industry to cope with the impacts of the pandemic. Moreover, most of tourism enterprises shared their increasing concern about the lack of more effective visions and measures from the government which could orient the local businesses, especially the small- and medium-sized enterprises, to better respond to the pandemic in the long term. According to the statistics, over 63% of the local businesses temporarily suspended operations, most of which were small- and medium-sized travel businesses. This finding reconfirmed the previous studies that the COVID-19 pandemic might have long-term impacts on all tourism-related businesses, and the recovery ability of medium- and small-sized companies is at serious risk ([Wieprow and Gawlik 2021](#)). Therefore, the governments at all levels should be more concerned about their leading role toward the goal of pandemic impact alleviation on the tourism industry and initiate prioritized tourism policies which could strengthen the recovery of all tourism-related businesses before it is too late.

Regarding the measures to reduce the impacts of the pandemic on the local tourism businesses, a collaborative approach was believed to better support the tourism enterprises in overcoming hits from the pandemic. The research findings in this study indicated that there have been different levels of suffering of different businesses and tourism enterprises against the pandemic crisis. Therefore, financial support from the government might consider a case-by-case basis ([Ministry of Industry and Trade of Vietnam 2021](#)). In addition, each enterprise should initiate their self-adjustment plan in a proactive way, enabling them to overcome waves of COVID-19 impacts. According to [Rosli and Jamil \(2020\)](#), the enterprises with efficient measures against pandemic might have a better chance to cope with difficulties during the crisis. This reconfirmed the significant role of tourism enterprises to revitalize their business capability rather than the dependence on the governmental support.

However, these findings do not mean that governments can underestimate their role towards addressing the most challenging difficulties related to the financial incapability of small enterprises, as discussed above. Therefore, the authority's timely policy responses could be a key factor that strengthen local business resilience. A good example of effective policy responses during the second wave of COVID-19 in Vietnam was that the governmental tourism stimulus package fostered the domestic tourism and saved local enterprises in Can Tho, recovering their destination capacity to around 60%. To some extent, this important evidence elicits a positive belief that the pandemic impacts on tourism businesses

could be alleviated, and tourism-related enterprises could be saved if proper measures are taken (Atalan 2020).

#### 6.4. Does the Size of Tourism Businesses Matter?

In response to the impact of the COVID-19 pandemic, tourism enterprises in Can Tho were likely to be the most vulnerable businesses. However, there were some key differences in the vulnerability related to the size of the local enterprises. There are many potential causes to explain this phenomenon. First of all, the tourism companies whose direct revenue mainly relies on tourists might have suffered more due to the matter of fact that tourist arrivals dropped significantly during the pandemic. Moreover, the findings in this study further explained that dependence on a specific tourism offering or target market might have led to financial crisis during lingering lockdowns in Vietnam. As a result, those big companies were likely to lose far more revenue than smaller enterprises.

However, the big company managers in this research supposed that the restructuring of their business model by diversifying tourism products and positioning the target market have enabled them to reduce the economic loss. A potential measure regarding the reduction in workforce was also found to be a temporary solution for all kinds of local businesses. This appears to be understandable, because downsizing the number of employees at tourist attractions has been a common measure for enterprises to alleviate finance pressure to survive during the pandemic (Hamilton 2020). Although big tourism enterprises could restructure their business in the short term, they were found to be more vulnerable in the long term. In general, the above-mentioned findings imply that the COVID-19 pandemic has severely affected the entire tourism industry of Can Tho city and the lingering crisis may lead to an entire collapse of the hospitality and tourism enterprises no matter what their size of business is. In order to prevent worse scenarios, governments at all levels may have offered special support to save different types of tourism enterprises which are almost on the brink of bankruptcy due to domino effects of the pandemic.

### 7. Conclusions

This research has highlighted the overall impacts of the COVID-19 pandemic on different sectors of the tourism industry in a developing city in Vietnam. The study found that there were differences in terms of the levels of impact on local tourism destinations throughout the various COVID-19 waves. The impact of the pandemic on the examined case study has generally caused a wide range of negative impacts in local destinations, including enormous losses in the tourism revenue, significant decreases in the number of both domestic and international tourist arrivals, the inadequacy of destination exploitation capacity, the temporary or permanent closure of tourism-related services, and the rising unemployment rate. In terms of the level of influence, all tourism businesses had suffered from the pandemic, ranging from serious to very serious levels.

However, there has been a difference in the degree of business damage, which can be seen from the percentage of customer decline, the decrease in absolute value, the relative turnover and the proportion of employee redundancies. The research findings also indicated that tourist attractions and tourism enterprises were the key stakeholders facing the biggest decline in the number of customers, the percentage of staff downsizing and the highest proportion of revenue decline. Additionally, tour operators, accommodations and dining establishments experienced the greatest losses in the absolute value of tourism revenue. However, it is noticeable that there was no difference in terms of the damage in each tourism service company in terms of decreases in the number of passengers, the percentage of tourism asset, service capacity, utilization and the absolute value of employee downsizing. Among the businesses, tourism enterprises were found to be the most vulnerable to the pandemic. More seriously, the pandemic crisis has caused a domino effect on different sectors of the local tourism system. Therefore, more than 20% of tourism-related enterprises have had to close their business, whereas the remainder have faced post-pandemic recovery challenges.

In response to the pandemic, the proactive measures initiated by the tourism enterprises were found to be effective, whereas financial solutions from the government were supposed to be critical but inefficient for local tourism revitalization. The effective measures reported by the local businesses included promoting the exploitation of the domestic tourist market, developing new products, ensuring safety for employees and tourists, developing quality tourism human resources, service price reduction, organizing a number of tourism stimulating events with a focus of motivating tourists, implementing capital support policies for each sector of the businesses, prioritizing domestic tourism recovery, ensuring hygiene at tourist sites and destinations and promoting the application of information technology in promoting destination images. In general, the staged model applied for crisis management during the second and the third waves of COVID-19 in Vietnam has been successful. These findings indicated that effective collaboration among all key stakeholders might contribute to alleviating the impacts of the pandemic.

Theoretically, this study provides a potential enrichment to the literature related to the global pandemic impacts and crisis management. This study indicates that there will be no “one-size-fits-all” approach to global pandemic crisis management such as for COVID-19. Therefore, this research adds a novel theoretical contribution to crisis- and disaster-management models for tourism destinations which should be flexibly staged and multiple strategic action plans integrated, because this global pandemic will cause lingering and repetitive impacts on tourism destinations. Moreover, the study sheds light on the roles of key stakeholders at different stages of pandemic, which contributes to building a strategic and holistic framework in effectively coping with pandemic impacts on different stages of the pandemic. Finally, the study offers better understanding of the vulnerability of tourism business and collective measures for instant pandemic responses in a more sustainable way.

Importantly, this study provides several practical implications for the tourism industry under the pressure of COVID-19 crisis. First of all, it provides destination managers better understanding about the strategic management to deal with the pandemic impacts and adjust potential measures to reduce the crisis consequences. In this regard, due to the long-lasting pandemic impacts, the surviving tourism enterprises should be more aware of the difficulties ahead. As such, the tourism enterprises should be adaptive to the impacts of the pandemic by restructuring their tourism products and target markets in order to survive during multiple waves of COVID-19. Importantly, tourism businesses should be more proactive by initiating their own measures to achieve post-crisis revitalization instead of passively relying on governmental support. The findings in this study also imply that the tourism system should have various action plans prepared to deal with similar global disasters in the future. It is also suggested that governments may need to take the leading role in emergent crisis management and address the conundrums associated with financial crises which directly affect destination resilience and tourism enterprises’ post-pandemic recovery prospects.

Although this study has attempted to provide both theoretical and practical implications regarding the impact of the COVID-19 pandemic on the tourism industry in a developing country context, there are still some limitations available for future research. The sample size of this study may not be representative for the whole tourism industry in Vietnam, but provides interesting ideas for similar research in different settings where the tourism industries may have also suffered multiple waves of COVID-19. In addition, potential research may investigate the effectiveness of governmental policy responses to the survival of the tourism industry and revitalization during and after pandemic. Last but not least, prospective studies may consider exploring key factors and stakeholders affecting the success of domestic tourism resilience during the pandemic.

**Author Contributions:** Data curation, G.V.H.D.; Formal analysis, D.V.H., N.T.N. and G.V.H.D.; Funding acquisition, D.V.H.; Investigation, T.T.K.T., N.T.N. and C.N.D.; Methodology, L.H.D.; Project administration, D.V.H.; Resources, C.N.D.; Supervision, L.H.D.; Validation, T.T.K.T.; Writing—original draft, D.V.H.; Writing—review & editing, L.H.D. All authors have read and agreed to the published version of the manuscript.

**Funding:** This research was funded by the Vietnam National Foundation for Science and Technology Development (NAFOSTED) under grant number: ĐXTN-2020.07.

**Conflicts of Interest:** The authors declare no conflict of interest.

## References

- Ái Lam. 2020. Du lịch Cần Thơ đón hơn 8,8 triệu lượt khách trong năm 2019. *Dân Trí*. Available online: <https://dantri.com.vn/du-lich/nam-2019-nganh-du-lich-can-tho-don-88-trieu-luot-khach-20200106101822273.htm> (accessed on 25 December 2020).
- Ái Lam. 2021. Cần Thơ: Thách Thức Cho Nhân Lực Ngành Du Lịch. *Báo Cần Thơ*. Available online: <https://baocantho.com.vn/thach-thuc-cho-nhan-luc-nganh-du-lich-a131323.html> (accessed on 27 December 2020).
- Anh, Lê Kim. 2020a. Ảnh Hưởng Của Dịch Covid-19 Tới Ngành Du Lịch Việt Nam. *Tạp Chí Công Thương*. Available online: <https://taphchicongthuong.vn/bai-viet/anh-huong-cua-dich-covid-19-toi-nganh-du-lich-viet-nam-72311.htm> (accessed on 20 March 2021).
- Anh, Vit ệ. 2020b. Phục Hồi Du Lịch Sau Đại Dịch. *Báo Nhân Dân*. Available online: <https://nhandan.vn/tag/phuchoidulichsaudaidich-53929> (accessed on 27 January 2021).
- Atalan, Abdulkadir. 2020. Is the lockdown important to prevent the COVID-19 pandemic? Effects on psychology, environment and economy-perspective. *Annals of Medicine and Surgery* 56: 38–42. [CrossRef]
- Bakar, Nashirah Abu, and Sofian Rosbi. 2020. Effect of Coronavirus disease (COVID-19) to tourism industry. *International Journal of Advanced Engineering Research and Science* 7: 189–93.
- Bartik, Alexander W., Marianne Bertrand, Zoe Cullen, Edward L. Glaeser, Michael Luca, and Christopher Stanton. 2020. The impact of COVID-19 on small business outcomes and expectations. *Proceedings of the National Academy of Sciences* 117: 17656–66. [CrossRef]
- Centeno, Raffy S., and Judith P. Marquez. 2020. How Much Did the Tourism Industry Lost? Estimating Earning Loss of Tourism in the Philippines. *arXiv arXiv:2004.09952*.
- Chang, Chia-Lin, Michael McAleer, and Vicente Ramos. 2020. A Charter for Sustainable Tourism after COVID-19. *Sustainability* 12: 3671. [CrossRef]
- Cheer, Joseph M. 2020. Human Flourishing, Tourism Transformation and COVID-19: A Conceptual Touchstone. *Tourism Geographies* 22: 514–24. [CrossRef]
- Deyshappriya, N. P., U. G. O. Sammani, and R. Minuwanthi. 2021. Impact of COVID-19 on Tourism Sector of Asia & Pacific Countries Evidence from 20 Asia-Pacific Countries. Sri Lanka. Vol. 20. Available online: <https://ssrn.com/abstract=3780713> (accessed on 28 December 2020).
- Dube, Kaitano, Godwell Nhamo, and David Chikodzi. 2021. COVID-19 pandemic and prospects for recovery of the global aviation industry. *Journal of Air Transport Management* 92: 102022. [CrossRef]
- García, Raquel, Christian Gayer, Werner Hölzl, Sergio Payo, Andreas Reuter, and Klaus Wohlrabe. 2020. *The Impact of the COVID-19 Crisis on European Businesses: Evidence from Surveys in Austria, Germany and Spain*. Munich: EconPol Policy Brief.
- Gertler, Paul J., Sebastian Martinez, Patrick Premand, Laura B. Rawlings, and Christel M. J. Vermeersch. 2016. *Impact Evaluation in Practice*. Washington, DC: World Bank Publications.
- Giang, Hoang Thi Nam, Jaffer Shah, Trinh Huu Hung, Abdullah Reda, Luong Ngoc Truong, and Nguyen Tien Huy. 2020. The first Vietnamese case of COVID-19 acquired from China. *The Lancet Infectious Diseases* 20: 408–9.
- Gole, Iulian, Razvan Catalin Dobre, and Carol Cristina Gombos. 2021. Aviation industry-challenges and uncertainties after the Covid-19 pandemic. *SHS Web of Conferences* 92: 01010. [CrossRef]
- Hamilton, Steven. 2020. From Survival to Revival: How to Help Small Businesses through the COVID-19 Crisis. The Hamilton Project Policy Proposal 2014–20. Available online: [https://static1.squarespace.com/static/59b0bb01f9a61e09f11924fa/t/5f62e96ad5319709d4a7b75f/1600317823206/THP\\_small\\_business.pdf](https://static1.squarespace.com/static/59b0bb01f9a61e09f11924fa/t/5f62e96ad5319709d4a7b75f/1600317823206/THP_small_business.pdf) (accessed on 28 December 2020).
- Haryanto, Tri. 2020. COVID-19 pandemic and international tourism demand. *JDE (Journal of Developing Economies)* 5: 1–5. [CrossRef]
- Higgins-Desbiolles, Freya. 2020. Socialising tourism for social and ecological justice after COVID-19. *Tourism Geographies* 22: 610–23.
- Hoque, Ashikul, Farzana Afrin Shikha, Mohammad Waliul Hasanat, Ishtiaque Arif, and Abu Bakar Abdul Hamid. 2020. The Effect of Coronavirus (COVID-19) in the Tourism Industry in China. *Asian Journal of Multidisciplinary Studies* 3: 52–58.
- Ismael, Nechirwan Burhan, Sarhang Sorguli, Hassan Mahmood Aziz, Bawan Yassin Sabir, Pshdar Abdalla Hamza, Bayar Gardi, and Farhad Rafaat Ali Al-Kake. 2021. The Impact of COVID-19 on Small and Medium-Sized Enterprises in Iraq. *Annals of the Romanian Society for Cell Biology* 25: 2496–505.
- Kalogiannidis, Stavros. 2020. Covid Impact on Small Business. *International Journal of Social Science and Economics Invention* 6: 387–91. [CrossRef]
- Kasare, Karishma S. 2020. Effects of Coronavirus Disease (COVID-19) on Tourism Industry of India. *Studies in Indian Place Names* 40: 362–65.

- Korstanje, Maximiliano E. 2021. Tourism Disaster Preparedness Post-COVID-19 Pandemic: The Example of Argentina. In *Tourism Destination Management in a Post-Pandemic Context*. Bingley: Emerald Publishing Limited.
- Krouk, Rim, and Fernando Almeida. 2021. Exploring the Impact of COVID-19 in the Sustainability of Airbnb Business Model. *arXiv* arXiv:2101.00281.
- Kuqi, Bekë, Elvis Elezaj, Bedri Millaku, Adem Dreshaj, and Nguyen Tan Hung. 2021. The impact of COVID-19 (SARS-CoV-2) in tourism industry: Evidence of Kosovo during Q1, Q2 and Q3 period of 2020. *Journal of Sustainable Finance & Investment* 1: 1–12.
- Long, Phan Hoàng, and Phạm Thị Tú Uyên. 2020. Ứng dụng lý thuyết hành vi dự định (tpb) trong nghiên cứu ý định lựa chọn khách sạn xanh của du khách tại thành phố Đà Nẵng. *Hue University Journal of Science: Economics and Development* 129: 81–95.
- Masondo, Happy. 2021. Business during a surreal pandemic. *Without Prejudice* 21: 18–19.
- McKim, Courtney A. 2017. The value of mixed methods research: A mixed methods study. *Journal of Mixed Methods Research* 11: 202–22.
- McManamy, Tegwyn, Jade Sheen, Leanne Boyd, and Paul A. Jennings. 2015. Mixed methods and its application in prehospital research: A systematic review. *Journal of Mixed Methods Research* 9: 214–31. [CrossRef]
- Mekong Delta Tourism Association. 2020. *Report on Tourism Recovery of Mekong Delta Region during the First Half of 2021*. Can Tho: Mekong Delta Tourism Association.
- Ministry of Industry and Trade of Vietnam. 2021. Control the Epidemic as Quickly as Possible, Determined not to Have a Health Crisis or an Economic Crisis. Available online: <https://moit.gov.vn/tin-tuc/hoat-dong/kiem-soat-dich-benh-nhanh-nhat-co-the-quyet-khong-de-khung-hoang-y-te-khung-hoang-kinh-te.html> (accessed on 28 December 2020).
- Ngoc Su, Diep, Diep Luc Tra, Hanh My Thi Huynh, Hai Hong Thi Nguyen, and Barry O'Mahony. 2021. Enhancing resilience in the Covid-19 crisis: Lessons from human resource management practices in Vietnam. *Current Issues in Tourism* 24: 1–17. [CrossRef]
- Nguyen, Kim Thanh Thanh. 2020. *Safety Plan during Covid-19 Pandemic in Restaurant Industry: Case Study: KOKORO Sushii*. Vantaa: Laurea University.
- Panzone, Luca A., Shaun Larcom, and Po-Wen She. 2021. Estimating the impact of the first COVID-19 lockdown on UK food retailers and the restaurant sector. *Global Food Security* 28: 100495. [CrossRef]
- Parikh, Samir D. 2020. Bankruptcy Tourism and the European Union's Corporate Restructuring Quandary: The Cathedral in Another Light. *University of Pennsylvania Journal of International Law* 42: 205.
- Phạm, Hồng Long, Thị Phương Vũ, and Ngọc Anh Đỗ. 2020. Ảnh hưởng của dịch bệnh Covid-19 đến hoạt động du lịch tại tỉnh Quảng Ninh. *Kinh Tế và Dự Báo* 53: 209–13.
- Prihadi, D. J., Z. Guanghai, and H. Nuraeni. 2021. The impacts of COVID-19 at Karangsang Mangrove Centre. In *Promoting Creative Tourism: Current Issues in Tourism Research*. Abingdon: Routledge, pp. 664–68.
- Quang, Tuyen D., Thi C. Tran, Vu H. Tran, Thao T. Nguyen, and Thu T. Nguyen. 2020. Is Vietnam ready to welcome tourists back? Assessing COVID-19's economic impact and the Vietnamese tourism industry's response to the pandemic. *Current Issues in Tourism*, 1–19. [CrossRef]
- Rassy, Dunia, and Richard D. Smith. 2013. The economic impact of H1N1 on Mexico's tourist and pork sectors. *Health Economics* 22: 824–34. [CrossRef]
- Rosli, Siti Nur Ayuni, and Nurul Nazlia Jamil. 2020. *Conceptual Framework Related To The Impact of Coronavirus Disease 2019 (Covid-19) on Malaysian Private Entity Reporting Standard (MPERS) Adoption By Small And Medium Enterprises (SMES) In Malaysia*. Penang: Universiti Sains Islam Malaysia.
- Sarkodie, Samuel Asumadu, and Phebe Asantewaa Owusu. 2021. Global Assessment of Environment, Health and Economic Impact of the Novel Coronavirus (COVID-19). *Environment, Development and Sustainability* 23: 5005–15.
- Shakya, Martina. 2009. *Risk, Vulnerability and Tourism in Developing Countries: The Case of Nepal*. Berlin: Logos Verlag Berlin GmbH, vol. 56.
- Sigala, Marianna. 2020. Tourism and COVID-19: Impacts and implications for advancing and resetting industry and research. *Journal of Business Research* 117: 312–21. [CrossRef]
- Terziyska, Ilinka, and Elka Dogramadjieva. 2021. Should I stay or should I go? Global COVID-19 pandemic influence on travel intentions of Bulgarian residents. *SHS Web of Conferences* 92: 2021.
- Thang, Vu Chien. 2020. Policy measures for viet nam tourism in response to impacts of COVID-19. *VNU Journal of Foreign Studies* 36: 197–206. [CrossRef]
- Tô, Trung Thành, and Trinh Bùi. 2020. Tác Động Của COVID-19 Đến Nền Kinh Tế-Những Đánh Giá Ban Đầu và Hàm ý Chính Sách. Available online: <http://103.7.177.7:80/handle/123456789/195812> (accessed on 25 October 2020).
- Tri, Nguyen Huu. 2021. Growth and economic development in Vietnam under the impact of COVID-19. *International Conference Universitas Pekalongan* 1: 7–12.
- Trường Đại học Kinh Tế Quốc Dân (Đ.H). 2020. Báo cáo đánh giá tác động của Covid 19 đến nền kinh tế và các khuyến nghị chính sách. Available online: <https://trungtamwto.vn/tin-tuc/15196-bao-cao-danh-gia-tac-dong-cua-covid-19-den-nen-kinh-te-va-cac-khuyen-nghi-chinh-sach> (accessed on 24 March 2021).
- Tuấn, Nguyễn. 2020. Du Lịch Thành Phố Cần Thơ—Một Năm Nhìn Lại. In *Du Lịch Việt Nam*. Available online: <https://vietnamtourism.gov.vn/index.php/items/35183> (accessed on 24 March 2021).
- TTXVN/VNP. 2020. Công Nghệ và Giải Pháp Cho Ngành Du Lịch—Dịch vụ Thời Kỳ Hậu COVID-19. Báo Ảnh Việt Nam. Available online: <https://vietnam.vnnet.vn/vietnamese/cong-nghe-va-giai-phap-cho-nganh-du-lich---dich-vu-thoi-ky-hau-covid-19/446955.html> (accessed on 24 March 2021).

- Ulak, Nimesh. 2020. A preliminary study of novel coronavirus disease (COVID-19) outbreak: A pandemic leading crisis in tourism industry of Nepal. *Journal of Tourism and Hospitality Education* 10: 108–31. [CrossRef]
- UNWTO. 2020. Impact Assessment of the Covid-19 Outbreak on International Tourism. Available online: <https://www.unwto.org/impact-assessment-of-the-covid-19-outbreak-on-international-tourism> (accessed on 25 October 2020).
- Van Nguyen, Huy, Minh Van Hoang, An Thi Minh Dao, Hoa L. Nguyen, Tien Van Nguyen, Phuong The Nguyen, Long Quynh Khuong, Phuong Mai Le, and Stuart Gilmour. 2020. An Adaptive Model of Health System Organization and Responses Helped Vietnam to Successfully Halt the Covid-19 Pandemic: What Lessons Can Be Learned from a Resource-constrained Country. *The International Journal of Health Planning and Management* 35: 988–92. [CrossRef]
- White, Howard. 2009. Theory-based impact Evaluation: Principles and practice. *Journal of Development Effectiveness* 1: 271–84.
- Wieprow, Joanna, and Agnieszka Gawlik. 2021. The Use of Discriminant Analysis to Assess the Risk of Bankruptcy of Enterprises in Crisis Conditions Using the Example of the Tourism Sector in Poland. *Risks* 9: 78.





Article

# The Impact of the COVID-19 Pandemic on Cross-Border Mergers and Acquisitions' Determinants: New Empirical Evidence from Quasi-Poisson and Negative Binomial Regression Models

Han-Sol Lee \*, Ekaterina A. Degtereva \* and Alexander M. Zobov \*

Department of Marketing, Peoples' Friendship University of Russia, Miklukho-Maklaya, 6, 117198 Moscow, Russia

\* Correspondence: 1042185141@pfur.ru (H.-S.L.); degtereva-ea@rudn.ru (E.A.D.); zobov-am@rudn.ru (A.M.Z.)

**Citation:** Lee, Han-Sol, Ekaterina A. Degtereva, and Alexander M. Zobov. 2021. The Impact of the COVID-19 Pandemic on Cross-Border Mergers and Acquisitions' Determinants: New Empirical Evidence from Quasi-Poisson and Negative Binomial Regression Models. *Economics* 9: 184. <https://doi.org/10.3390/economics9040184>

Academic Editor: Ștefan Cristian Gherghina

Received: 18 September 2021  
Accepted: 27 October 2021  
Published: 18 November 2021

**Publisher's Note:** MDPI stays neutral with regard to jurisdictional claims in published maps and institutional affiliations.



**Copyright:** © 2021 by the authors. Licensee MDPI, Basel, Switzerland. This article is an open access article distributed under the terms and conditions of the Creative Commons Attribution (CC BY) license (<https://creativecommons.org/licenses/by/4.0/>).

**Abstract:** The cross-border movement of capital has suffered due to the COVID-19 pandemic since December 2019. Nevertheless, it is unrealistic for multinational companies to withdraw giant global value chains (GVCs) overnight because of the pandemic. Instead, active discussions and achievements of deals in cross-border mergers and acquisitions (M&As) are expected in the post-COVID-19 era among various other market entry modes, considering the growing demand in high technologies in societies. This paper analyzes particular determinants of cross-border mergers and acquisitions (M&As) during the pandemic year (2020) based on cross-sectional datasets by employing quasi-Poisson and negative binomial regression models. According to the empirical evidence, COVID-19 indices do not hamper M&A deals in general. This indicates that managerial capabilities of the coronavirus, not the outbreak itself, determined locational decisions of M&A deals during the pandemic. In this vein, it is expected that the vaccination rate will become a key factor of locational decision for M&A deals in the near future. Furthermore, countries that have been outstanding in coping with COVID-19 and thus serve as a good example for other nations may seize more opportunities to take a leap forward. In addition, as hypothesized, the results present positive and significant associations with M&A deals and the SDG index, confirming the resource-based theory of internationalization. In particular, the achievement of SDGs seems to exercise much influence in developing countries for M&A bidders during the pandemic year. This indicates that the pandemic demands a new zeitgeist that pursues growth while resolving existing but disregarded environmental issues and cherishes humanitarian values, for all countries, non-exceptionally, standing at the start line of the post-COVID-19 era.

**Keywords:** entry mode; mergers and acquisitions (M&As); sustainable development goal (SDG) index; COVID-19; generalized linear model (GLM)

## 1. Introduction

The COVID-19 pandemic has been sweeping the world (since December 2019), and the world economy has survived an impressive recession; in 2020, the world (nominal) GDP fell by 3.3% (IMF 2021). In particular, as multiple countries closed or tightly controlled their territorial borders to hamper the spread of the coronavirus, the cross-border movement of capital also suffered, and as a result, in 2020, FDI volume decreased by 42% (UNCTAD 2021).

International companies have been significantly affected by uncertainties caused by the health pandemic by reducing their foreign direct investment (FDI) activities (Ho and Gan 2021). Nevertheless, most countries have already been long convinced that internationalization is not a choice but a fate to accept to surmount insufficient domestic markets (in terms of production factors and business opportunities) (Moon et al. 1995, 1998), and it is hardly expected for multinational companies to withdraw giant global value

chains (GVCs) overnight due to the pandemic. In addition, for developing economies, foreign capital inflows have played a critical role in their economic growth (Ioan et al. 2020). In this sense, in the long-term perspective, the public and private sectors would best prepare for a post-COVID-19 era by developing new technologies and adopting the spirit of the new times to restore the international capital movement to that of a pre-pandemic era.

In particular, we expect active discussions and achievements of deals in cross-border mergers and acquisitions (M&As) in the post-COVID-19 era among various other market entry modes, considering the growing demand in high technologies in societies. In practice, COVID-19 accelerates the dawn of a non-contact era, which will require standard digital infrastructure. Most things have happened in a remote mode, as some countries utilize smart phone applications for efficient quarantines (for instance, South Korea's surveillance application of live tracking of a subject person in self-isolation). Multiple studies reveal that digital technology played a critical role in surveilling and controlling the COVID-19 disease (Kumar et al. 2020; Ting et al. 2020; Whitelaw et al. 2020; He et al. 2021) and will be necessary in the post-COVID-19 era (Strusani and Hounghonon 2020; Xie et al. 2020).

Furthermore, the contagious disease reminds societies of the importance of resolving existing environmental issues, as the pandemic enlightens people on how health problems can destroy and paralyze economic systems. This leads to the demand for new green technologies (Agrawala et al. 2020; Chiappinelli et al. 2021; Mohideen et al. 2021), which highly require the transfer of technology from developed to developing countries. In this sense, we expect that in the post-COVID-19 era, M&A deals will be actively accomplished in target countries that are highly developed in the innovation index, particularly in green technologies (which is in line with the zeitgeist of the post-COVID-19 era and requires nature and society to coexist as a whole).

The main theoretical contribution of this paper is to extend a resource-based view of firms' internationalization (particularly in terms of cross-border M&As) in the year 2020 as reflecting the necessary zeitgeist of the post-pandemic era. Over the last decades, M&As have been explored in diverse themes (for instance, their impact on stock returns, abnormal returns, etc., synergies, value chain creation, performance outcomes, etc.) (Hutzschenreuter et al. 2012; Nguyen et al. 2021). However, this study focuses on determinants of M&As (Rossi and Volpin 2004; Wang 2008; Nguyen et al. 2021, etc.) based on the assumption that M&As are a factor for sustainable economic growth by attracting foreign capital in target countries and the impact of COVID-19 on its determinants. To do this, our regression models include the SDG index and COVID-19 indices as key explanatory variables. The results of this paper can be used to establish guidelines for proper innovation for countries in the post-pandemic era to become an attractive destination of M&A deals without sacrificing the environment and humanitarian values for economic growth.

The remainder of this paper is structured as follows. Section 2 is a literature review on the theoretical frames of firms' internationalization and COVID-19's impacts on the main motivation of business and social activities. Section 3 presents econometric models and methodologies. Section 4 analyzes the results of quasi-Poisson and negative binomial regression models. Section 5 discusses conclusions and policy implications based on the results of the regression analyses.

## 2. Literature Review

There have been multiple attempts to empirically investigate the motivating factors of M&As by employing one firm's internationalization theoretical frames: an industry-based view, institution-based view and resource-based view. Some recent studies articulate motivations of M&As based on the industry-based view, which explains cross-border M&As mainly as an action to increase efficiencies amid severe market competition. For instance, according to research performed by Yu (2020), who explores the motivations and performances of vertical M&As, cost reduction and income from the initial investment (which offsets new costs) are verified as a main driving force of vertical M&As. In a study by Soni et al. (2019) on domestic and cross-border M&A motivations of Indian IT

companies from 2000 to 2015, market-seeking and efficiency-seeking are confirmed as a main driving force of M&As, but the latter motivation has gained strength after the global financial crisis (2008). [Erel et al. \(2012\)](#) investigates 56,978 cases of cross-border mergers outside of the United States, and there, we find an industry-based view. The results show that the appreciation of a currency (which is pointed out as a major factor) is associated with the decision to become a buyer company of cross-border mergers.

Other papers look for evidence of M&As by employing the institution-based view, describing cross-border M&As as a means to overcome institutional constraints at a home country. [Deng \(2009\)](#) asserts that Chinese firms go abroad to obtain strategic assets of international companies, but the reason behind these resource-driven M&As is rooted in institutional constraints of the home country. A study by [Pablo \(2009\)](#) on cross-border M&As in Latin America confirms that regardless of target or bidder countries, macro-economic and business environments are determining factors in M&A deals. The significance of institutional quality of target countries is further addressed in the following studies on international capital movements ([Hyun and Kim 2010](#); [Rjoub et al. 2017](#); [Dowling and Vanwalleghem 2018](#)).

However, compared to greenfield investments or joint ventures (JVs), multiple studies, in particular, under the resource-based view to explain M&As by considering it an act of strategic asset-seeking. To catch up with technologies as a late-mover, a large number of multinational companies of developing countries complete M&As with companies in developed countries ([Liang et al. 2021](#)) as a rapid and efficient way to gain international market competitiveness ([Li 2011](#)). [Sun et al. \(2012\)](#) further stress the necessity of more than one M&A deal for companies of emerging countries because absorbing and developing high skills are outcomes from a continuous learning process rather than an overnight achievement. Additionally, a study by [Pradhan \(2010\)](#) points out that Indian pharmaceutical firms' cross-border acquisition seeks both market expansion and strategic assets. A recent study by [Hu et al. \(2020\)](#) suggests an interesting conclusion from observations of Chinese manufacturing firms' M&As for the period of 2009 to 2015; cross-border M&As have negative impacts on buyers' rival companies, particularly in high-tech industries.

In this sense, considering all three theoretical view-points of M&As we addressed above and the fact that that M&A deals are still mainly made in developed countries (around 80% of the total M&A deals in terms of M&A value in 2020) ([World Investment Report 2021a](#)), which includes both flows between developed countries and from developing to developed countries, our study assumes that strategic asset-seeking is a main driving factor in determining M&A locations. Then, we can raise a question related to an existing pivotal motivation of M&As and the impacts of the COVID-19 pandemic on it.

The COVID-19 pandemic has awakened people to the necessity of innovation in environmental and social systems, especially those centered on developed countries. People have realized how environmental pollution make a society vulnerable to contagious diseases and disrupt our normal daily lives. Conversely, people witness how much air pollution emissions have decreased during lockdowns throughout the world. In this vein, recent studies investigate relationships of environmental parameters with COVID-19 (or impacts of COVID-19 on environmental parameters) and their further linkage to a path of innovation, where our lifestyle and future as a whole should strive to move forward (for instance, [Barcelo 2020](#); [Bashir et al. 2020](#); [Megahed and Ghoneim 2020](#); [Facciola et al. 2021](#)).

To reflect on these circumstances and notions, the authors suggest that asset-seeking of M&As during and after the pandemic era should not simply be measured as a level of innovation (e.g., R&D expenditure ratio, the number of patents, etc.) but according to SDGs-related technologies, such as improving humanitarian values and resolving environmental problems. The importance of SDGs-oriented innovation, which focuses on humans and the environment, has been underlined by several studies (i.e., [Uang and Liu 2013](#); [Calabrese et al. 2018](#); [Soares et al. 2020](#); [Walsh et al. 2020](#)). The COVID-19 pandemic expedites the association between the environment and the economy ([Srivastava et al. 2020](#)), which legitimates environmental-friendly and sustainable development as a new growth path

(Bhattacharya and Stern 2020) and promotes awareness and the appreciation of nature, something we used to take for granted) (Rousseau and Deschacht 2020).

This paper assesses innovation (to measure the asset-seeking nature of M&A motives) in relation to the SDG index as reflecting the growing significance of sustainability-oriented innovation. In addition, we include variables related to COVID-19 to observe the impacts of the pandemic on locational decisions of M&A deals. It should further be considered that black swan events in the world economy have affected developed and developing countries in a different way. In a study by Reddy et al. (2014), which explores the impact of the 2007–2008 global financial crisis on cross-border M&As, it is revealed that developing countries obtained opportunities to acquire companies in developed countries with advantageous asset prices in the post-crisis periods. Similarly, Rao-Nicholson and Salaber (2016) reviewed the impact of the 2007–2008 global financial crisis on cross-border M&As, particularly in banking sectors, and asserted that developing countries' banks became the main purchasers during the post-crisis periods. In this regard, our study further compares the impacts of the COVID-19 pandemic in developed and developing countries.

### 3. Descriptive Data and Model Specifications

M&A datasets are selected in terms of M&A target (seller) countries. As presented in Table 1, M&A\_number is a count variable and is therefore not normally distributed, indicating that it is not appropriate to apply ordinary least squares (OLS) regression. Conversely, UNCTAD statistics calculate the number of M&A deals by employing a net basis methodology. This implies that as divestments (sales of foreign affiliates to domestic firms) are subtracted, some countries' number of M&A deals are shown as negative values. In this sense, 145 countries with M&A deals  $\geq 0$  are made up of cross-section datasets (for the year 2020) to apply generalized linear model (GLM) regression analyses for a count variable. The list of countries and data sources are provided in Tables A1 and A2, respectively. Based on the previous literature, we draw that M&As are mainly associated with market-seeking, efficiency seeking and asset-seeking in a broad aspect as one method of foreign direct investment while considering asset-seeking as the main motivation. Unlike previous studies, which simply measured innovation capacity based on either the R&D expenditure ratio or patent indices, this study assesses innovation in relation to the SDG index, which is a comprehensive parameter, to estimate asset-seeking motivations as reflecting a desirable path of innovation in the post-COVID-19 era. We further assumed that COVID-19 indices significantly affect M&A activities and decisions of multinational companies during the pandemic year. In this vein, we set COVID-19 and SDG indices as key independent variables.

In terms of methodology, Poisson regression is pre-tested. However, over-dispersion is observed, which contradicts the basic assumption of Poisson regression analysis—the mean and variance should be equal. To deal with the over-dispersion issue, quasi-Poisson and negative binomial regression analyses, which are estimators of GLM to allow over-dispersion (Ver Hoef and Boveng 2007; Lindén and Mäntyniemi 2011; Naji et al. 2020), are employed to fit our models. The regression analyses were performed with R software (version 4.1.0) and “GLM2” and “MASS” packages were utilized. The equations of our regression models are as follows:

$$M\&A_{numberi} = \exp(\beta_0 + \beta_1 \ln(Corona_{case})_i + \beta_2 \ln(SDG)_i + \beta_3 \ln(CPI)_i + \beta_4 \ln(Per_{capita})_i + \varepsilon_i) \quad (1)$$

$$M\&A_{numberi} = \exp(\beta_0 + \beta_1 Corona_{deathi} + \beta_2 \ln(SDG)_i + \beta_3 \ln(CPI)_i + \beta_4 \ln(Per_{capita})_i + \varepsilon_i) \quad (2)$$

where  $M\&A_{numberi}$  denotes the number of M&A deals of country  $i$ . Various parameters in regression models were used to estimate the impact of the coronavirus, but confirmed cases were for the most part determined by previous research (Cyrus et al. 2020; Pavlyshenko 2020; Liu et al. 2020; Abbas et al. 2021; Yan and Zhu 2021). In this sense,  $\ln(Corona_{case})_i$ —a natural logarithm of total COVID-19 cases (per million people) of a country  $i$  is used as a proxy to the impact of COVID-19. However, for a more robust estimation, we approach COVID-19 with an additional and different proxy and clarify the consistency of

results. Here,  $Corona_{death_i}$  (total COVID-19 deaths/total COVID-19 cases) is used as another COVID-19 variable.  $Ln(SDG)_i$  denotes a natural logarithm of the SDG index (score 0–100) of country  $i$ .

**Table 1.** Variables and descriptive data (for the year 2020) analysis.

Variable Name	Mean	S.D	Minimum	Maximum	Skewness	Kurtosis	N
Dependent variable							
M&A_number	42.03448	136.8423	0.000000	1085.000	5.690170	37.88590	145
COVID-19 variables (key)							
Ln(Corona_case)	8.540317	2.184558	1.180499	11.24921	−0.969944	3.392527	145
Corona_death	0.022593	0.026950	0.000000	0.290615	7.111488	69.13461	145
Asset-seeking variable (key)							
Ln(SDG)	4.205416	0.149954	3.778508	4.439400	−0.700598	2.544913	145
Efficiency-seeking variable (control)							
Ln(CPI)	5.077244	0.548704	4.593321	8.171515	2.921059	14.13648	145
Market-seeking variable (control)							
Ln(Per_capita)	8.734716	1.420445	6.120603	11.67026	0.024867	2.081489	145

Source: composed by authors.

Moreover,  $Ln(CPI)_i$  (a natural logarithm of Consumer Price Index (CPI) of country  $i$ ) and  $Ln(Per_{capita})_i$  (a natural logarithm of GDP per capita (dollars at current prices) of country  $i$ ) are included as control variables to capture efficiency-seeking and market-seeking motivations, respectively, considering that cost reductions and market expansion amid competition also affect firms' locational decisions on M&As (Yang et al. 2009). Our research hypotheses are as follows:

**Hypothesis 0 (H0).**  $Ln(Corona\_case)$  is negatively associated with  $M\&A\_number$ .

**Hypothesis 1 (H1).**  $Corona\_death$  is negatively associated with  $M\&A\_number$ .

**Hypothesis 2 (H2).**  $Ln(SDG)$  is positively associated with  $M\&A\_number$ .

**Hypothesis 3 (H3).**  $Ln(CPI)$  is negatively associated with  $M\&A\_number$ .

**Hypothesis 4 (H4).**  $Ln(Per\_capita)$  is positively associated with  $M\&A\_number$ .

Before running quasi-Poisson and negative binomial regression analyses, we conducted Pearson's correlation tests for dependent and independent variables. As described in Table 2,  $Ln(Corona\_case)$  is positively correlated with  $M\&A\_number$  at the 5% significance level.  $Ln(SDG)$  shows a positive correlation with  $M\&A\_number$  at the 1% significance level.  $Ln(Corona\_case)$  shows positive co-movement with  $Ln(SDG)$  at the 1% significance level, while  $Corona\_death$  presents a negative correlation with  $Ln(SDG)$  at the 10% significance level. In addition, we conducted variance inflation factor (VIF) tests to capture potential multicollinearity issues in the linear function. As described in Table 3, our explanatory variables' VIF are all below 5, which indicate no concern of multicollinearity.

**Table 2.** Coefficients of Pearson's correlation tests.

	M&A_Number	Ln(Corona_Case)	Corona_Death	Ln(SDG)
M&A_number	1.000000	—	—	—
Ln(Corona_case)	0.193397 (0.0198) **	1.000000	—	—
Corona_death	0.002935 0.9720	−0.143106 (0.0860) *	1.000000	—
Ln(SDG)	0.291042 (0.0004) ***	0.626793 (0.0000) ***	−0.153034 (0.0661) *	1.000000

Note:  $p$  values in parentheses \*  $p < 0.1$ , \*\*  $p < 0.05$ , and \*\*\*  $p < 0.01$ . Source: composed by authors.

**Table 3.** Variance inflation factor (VIF) tests.

	All Countries		Developed Countries		Developing Countries	
Ln(Corona_case)	1.692732	-	1.020802	-	1.485333	-
Corona_death	-	1.067852	-	1.148092	-	1.071136
Ln(SDG)	3.341304	2.987665	1.123278	1.131519	2.226291	2.001954
Ln(CPI)	1.182253	1.224407	1.013034	1.032143	1.051730	1.095998
Ln(Capita)	3.061884	2.988518	1.156723	1.243078	2.060471	1.992372

Source: composed by authors.

#### 4. GLM (Generalized Linear Model) Estimation Results and Discussion

Table 4 describes the results of quasi-Poisson and negative binomial regression analyses for all countries. Contrary to the hypothesis, the coefficient of Ln(Corona\_case) is positive but insignificant regardless of GLM estimators. This implies that the number of COVID-19 cases is not a determining factor of M&A deals of target countries. Furthermore, the results of Corona\_death are not robust. The results present a positive coefficient in the quasi-Poisson regression model [2] at the 1% significance level (rejection of H1), but its significance disappears in negative binomial model [4].

**Table 4.** Results of GLM (generalized linear model) analysis for all economies.

Estimator	Quasi-Poisson		Negative Binomial	
	[1]	[2]	[3]	[4]
Constant	−26.9462 ** (11.7524)	−28.5382 ** (13.5219)	−25.4214 *** (6.7998)	−25.1714 *** (6.5112)
COVID-19 impacts				
Ln(Corona_case)	0.0453 (0.1207)	-	0.0205 (0.0837)	-
Corona_death	-	20.0127 *** (6.8708)	-	1.9449 (5.7073)
Asset-seeking				
Ln(SDG)	4.8366 * (2.6816)	5.0382 * (2.9821)	5.1044 *** (1.7806)	5.0655 *** (1.6884)
Efficiency-seeking				
Ln(CPI)	0.0617 (0.6268)	−0.0796 (0.7357)	0.0063 (0.2915)	−0.0101 (0.2949)
Market-seeking				
Ln(Per_capita)	0.9384 *** (0.2362)	1.0769 *** (0.2601)	0.7152 *** (0.1744)	0.7299 *** (0.1723)
Observations	145	145	145	145

Note: standard errors in parentheses, \*  $p < 0.1$ , \*\*  $p < 0.05$ , and \*\*\*  $p < 0.01$ . Source: composed by authors.

The coefficient of Ln(SDG) is positive and significant throughout the models [1]–[4] regardless of GLM estimators. This confirms strong asset-seeking motivations of M&A

deals during the pandemic year for the sustainable development of target countries, which supports the resource-based-view hypothesis (support of H2).

In terms of control variables, the coefficient sign of Ln(CPI) is not consistent depending on GLM estimators without statistical significance. However, Ln(Per\_capita) presents a consistent positive coefficient throughout models [1]–[4] at the 1% significance level (support of H4). This indicates that during the pandemic year 2020, efficiency-seeking was not a main motivation for M&A deals while international companies were highly driven by market-seeking purposes.

These results lead us to the question of whether the same results would be repeated in models dividing economic groups or if each economic group would show a distinguishable impact of COVID-19 factors and other M&A bidders' motivations (which are confirmed to be asset-seeking and market-seeking in models for all countries).

In this sense, as shown in Table 5, we further conducted a regression analysis by dividing observations into developed and developing economies.

**Table 5.** Results of GLM (generalized linear model) analysis for developed versus developing economies.

Economy	Developed				Developing			
Estimator	Quasi-Poisson		Negative Binomial		Quasi-Poisson		Negative Binomial	
Model	[5]	[6]	[7]	[8]	[9]	[10]	[11]	[12]
Constant	−31.7347 (38.9896)	−63.3726 (37.7889)	−38.0033 (26.9740)	−42.0723 * (23.3921)	−23.7247 * (12.4020)	−22.1358 * (12.3961)	−27.2049 *** (7.8886)	−27.6833 *** (7.5618)
COVID-19 impacts								
Ln(Corona_case)	0.1336 (0.2403)	-	0.1304 (0.1643)	-	−0.1117 (0.1046)	-	0.0103 (0.1012)	-
Corona_death	-	84.6211 *** (26.6780)	-	89.8634 *** (19.0938)	-	6.8596 (8.3078)	-	−1.9845 (6.8866)
Asset-seeking								
Ln(SDG)	0.8125 (6.8623)	4.1285 (6.1952)	−0.5542 (5.4884)	1.3399 (4.6878)	5.6421 * (3.0491)	5.1160 * (3.0117)	6.3668 *** (2.0777)	6.4921 *** (1.9801)
Efficiency-seeking								
Ln(CPI)	4.4970 (3.9317)	6.8074 * (3.7680)	4.8754 * (2.9159)	3.3847 (2.5061)	−0.1151 (0.5146)	−0.1998 (0.5105)	0.0054 (0.3298)	0.0243 (0.3360)
Market-seeking								
Ln(Per_capita)	0.9839 ** (0.4525)	1.5276 *** (0.4813)	1.9691 *** (0.3323)	2.1855 *** (0.2935)	0.4242 (0.2866)	0.4194 (0.2879)	0.2856 (0.2381)	0.2843 (0.2343)
Observations	37	37	37	37	108	108	108	108

Note: standard errors in parentheses, \*  $p < 0.1$ , \*\*  $p < 0.05$ , and \*\*\*  $p < 0.01$ . Source: composed by authors.

The coefficient of Ln(Corona\_case) is consistently insignificant in developed and developing countries regardless of GLM estimators. This means that the outbreak of the coronavirus itself does not hamper a country's selection as a target country in M&A deals. A lack of negative impacts of Ln(Corona\_case) in developed economies displays convincing data that these countries hold strong capacities and systems to handle contagious diseases. Thus, M&A bidders may have high expectations of prompt vaccinations in developed countries, which can lead to the expectation that the pandemic can be relatively easily controlled in developed countries as opposed to developing countries.

There requires further explanation on why Ln(Corona\_case) does not hinder of M&A deals in developing countries as well. As revealed in a study by Hayakawa and Mukunoki (2021), the impacts of the COVID-19 can be different even between developing economies depending on various factors, such as a country's position in trade and geographical location. In this sense, the results become acceptable when we look at the main target countries of M&A deals (420 out of 907 M&A deals in developing countries in 2020) amongst developing countries. The developing countries are East Asian (e.g., China, Hong Kong (China), Republic of Korea and Taiwan province of China) and Southeast Asian (e.g., Singapore, Malaysia, Indonesia, Vietnam, etc.) countries, and many of them are developed enough to handle contagious diseases, despite the fact that they are categorized as developing economies, according to UNCTAD.



However, *Corona\_death* shows positive coefficients in developed countries in models [6] and [8] at the 1% significant level (rejection of H2), which is in the same line as model [2] for all countries. This can be explained by the high aging index of major M&A sellers from developed countries. The top 10 M&A seller countries during the pandemic year were the United States, Canada, United Kingdom, Germany, France, Netherlands, Australia, Italy, Spain and Sweden, which contain large populations of people over the age of 65. The average *Corona\_death* of these 10 countries is 0.024496, which surpasses that of all countries (0.022593), even developing countries (0.023776). Conversely, the average GDP per capita of these 10 countries is 44,772 U.S. dollars.  $\ln(\text{Per\_capita})$  presents positive coefficients at the 1% significance level throughout models [5]–[7] (support of H4). This indicates that market attractiveness was a strong main determinant of M&A deals in developed countries during the pandemic year even when we consider the risks of the coronavirus. As discussed in a study by [Kooli and Son \(2021\)](#), a favorable macro-economic environment encouraged M&A deals during the pandemic. This becomes clear when comparing the data with that for developing countries. The significance of  $\ln(\text{Corona\_death})$  and  $\ln(\text{Per\_capita})$  disappear in developing countries. In this sense, the positive association of  $\ln(\text{Corona\_death})$  with *M&A\_deals* is applicable only to limited high per capita groups of developed countries, not all countries general.

$\ln(\text{SDG})$ , however, turns out to be a much more significant determinant in developing countries; its coefficient consistently shows positive signs with statistical significance, while the statistical significance in models composed of developed countries disappears. This can be partially explained by the fact that as SDGs are at the center of policy making in developed countries, a level gap in the SDG index among these countries (which is insignificantly trivial) does not have a huge impact in the selection of a target country for M&A deals. As demonstrated in a study by [Kaya \(2020\)](#), developed countries showed better performances than developing countries in sustainable development during the pandemic. This is also indicative of how a level of achievements in SDG plays a critical role in attracting M&A deals, especially in developing countries. It further shows that fulfilling SDGs is no longer optional but mandatory in the post-pandemic era ([Van Zanten and Tulder 2020](#)).

Meanwhile, efficiency-seeking is not a main motive regardless of economic groups.  $\ln(\text{CPI})$  even shows positive coefficients with statistical significance in models [6] and [7] of developed economies to contradict the H3 of efficiency-seeking. The coefficients of  $\ln(\text{CPI})$  are inconsistent in terms of a sign and statistical significance in models for developing countries. These results contradict the industry-based view (e.g., [Erel et al. 2012](#); [Soni et al. 2019](#); [Yu 2020](#)) but are understandable considering the extraordinarily high costs in crossing borders during the pandemic (which hindered companies seeking efficiencies from cross-border M&As). In addition, the asset-seeking of M&As seems to have accelerated in relation to sustainable development in the post-pandemic era. In particular, for sustainability, the significance of smart cities, which utilize massive datasets with high technologies, is expected to increase in the post-pandemic era ([Lyons and Lázároiú 2020](#); [Scott et al. 2020](#)).

## 5. Conclusions and Implications

This paper examined the impacts of the COVID-19 pandemic on determinants of cross-border M&As. The results of quasi-Poisson and negative binomial regression analyses (based on cross-sectional data in the year 2020) confirmed that COVID-19 indices (namely total new coronavirus cases) do not hamper M&A deals in general. As the statistics of total coronavirus cases are somehow related to how actively a government tests potentially infected people according to their COVID-19 quarantine guidelines and receiving capabilities, it is likely that the total number of cases itself does not exert influence on M&A deals. The results are consistent in developed and developing countries. This is because the main target countries of M&A deals are developed countries (5225 out of 6201 M&A deals in the world in 2020), and even M&A deals in developing countries (420 out of 907

M&A deals in developing countries in 2020) were mostly made in East Asian (e.g., China, Hong Kong (China), Republic of Korea and Taiwan province of China) and Southeast Asian (e.g., Singapore, Malaysia, Indonesia, Vietnam, etc.) countries, many of which are developed enough to handle contagious diseases, despite the fact that they are categorized as developing economies, according to UNCTAD.

From the authors' point of view, managerial capabilities of the coronavirus, not the outbreak itself, determined locational decisions of M&A deals during the pandemic. In this vein, we expect that the vaccination rate will become a significant determinant in the near future. Furthermore, countries that have been outstanding in coping with COVID-19 and thus serve as a good example for other nations, may seize more opportunities to take a leap forward. However, developed countries may encounter serious stagnation if they fail to successfully control the coronavirus and consequently face social chaos. COVID-19 revealed the negative aspects of societies regardless of the economic wealth of countries. In addition, as proved in previous studies, black swan events (e.g., 2007–2008) may serve as new business opportunities for companies in developing countries (Reddy et al. 2014; Rao-Nicholson and Salaber 2016).

However, the death rate of the coronavirus showed mixed results; the significance of its coefficient is different between quasi-Poisson and negative binomial models. In addition, the death rate of the coronavirus showed positive associations with statistical significance in developed countries while its significance disappeared in developing countries. This is because market attractiveness was too strong of a main determinant of M&A deals in developed countries during the pandemic year, even when taking into consideration the risks of the coronavirus. The positive association of the death rate of the coronavirus with M&A\_deals is applicable only to limited high per capita groups of developed countries, not countries in general.

In addition, as presumed, we found strong positive and significant associations with M&A deals and SDG and innovation variables, confirming the resource-based view of internationalization. In particular, the achievement of SDGs seems to exercise much influence for developing countries for M&A bidders in the pandemic year. However, as SDGs are at the center of policy making in developed countries, a level gap in the SDG index among these countries (which is insignificantly trivial) does not have a huge impact in the selection of a target country for M&A deals.

As the pandemic alerts us to sustainable development, which pursues growth while resolving existing but disregarded environmental issues by applying technological innovations, it may become inevitable for developing countries, countries that are late-comers and thus whose government policies have been economic growth-centered, to orient their policies towards environmental and humanitarian values. However, this requires the cooperation and support from developed countries, who may need to stop considering developing countries as countries from which they can exploit ownership advantages (which have been non-environmentally friendly but widely used during the pre-pandemic era). Rather, these countries should voluntarily invest in SDG-related sectors with humanitarian partnerships and avoid investments devastating developing countries' environments and societies with their long-term visions.

In this sense, we highly encourage governments to implement industrial development projects and guidelines related to SDGs such that international firms can more actively strive to develop environment-friendly production and sales methods. However, one of the lessons we have learnt during the pandemic era is the importance of social unity. The control of the coronavirus' spread has been highly dependent on the cooperation of society as a whole to follow quarantine guidelines. Regardless of existing economic groups, all countries stand at the start line of the post-COVID-19 era amid chaos derived from the pandemic. This implies that the world economic order may be critically rearranged depending on how thoroughly we prepare for and respond to a post-COVID-19 era. The COVID-19 pandemic served as an impetus to remind us how environmental issues and contagious diseases can paralyze economies as we look back on the history of mankind.

**Author Contributions:** Supervision, A.M.Z.; writing—original draft, H.-S.L.; writing—review and editing, E.A.D. All authors have read and agreed to the published version of the manuscript.

**Funding:** This research received no external funding.

**Institutional Review Board Statement:** Not applicable.

**Informed Consent Statement:** Not applicable.

**Data Availability Statement:** Not applicable.

**Conflicts of Interest:** The authors declare no conflict of interest.

## Appendix A

**Table A1.** List of countries.

Developed countries																																																																																																													
Australia	Austria	Belgium	Bulgaria	Canada	Croatia	Cyprus	Czechia	Denmark	Estonia	Finland	France	Germany	Greece	Hungary	Iceland	Ireland	Israel	Italy	Japan	Latvia	Lithuania	Luxembourg	Malta	Netherlands	New Zealand	Norway	Poland	Portugal	Romania	Slovakia	Slovenia	Spain	Sweden	Switzerland	United Kingdom	United States																																																																									
Developing countries																																																																																																													
Afghanistan	Albania	Algeria	Angola	Argentina	Armenia	Azerbaijan	Bahrain	Bangladesh	Belarus	Belize	Benin	Bolivia	Bosnia and Herzegovina	Botswana	Brazil	Brunei	Darussalam	Burkina Faso	Cambodia	Cameroon	Chad	Chile	China	Colombia	Congo	Democratic Republic of Costa Rica	Côte d'Ivoire	Dominican Republic	Ecuador	Egypt	El Salvador	Eswatini	Ethiopia	Fiji	Gambia	Georgia	Ghana	Guatemala	Guinea	Guyana	Haiti	Honduras	India	Indonesia	Iran, Islamic Republic of	Iraq	Jamaica	Jordan	Kazakhstan	Kenya	Korea, Republic of	Kuwait	Kyrgyzstan	Lao	People's Democratic Republic	Lebanon	Liberia	Madagascar	Malawi	Malaysia	Maldives	Mali	Mauritius	Mexico	Moldova, Republic of	Mongolia	Montenegro	Morocco	Mozambique	Myanmar	Namibia	Nepal	Nicaragua	Niger	Nigeria	North Macedonia	Pakistan	Panama	Papua New Guinea	Paraguay	Peru	Philippines	Qatar	Russian Federation	Rwanda	Saudi Arabia	Senegal	Serbia	Sierra Leone	Singapore	South Africa	Sri Lanka	Sudan	Suriname	Thailand	Togo	Trinidad and Tobago	Tunisia	Turkey	Uganda	Ukraine	United Arab Emirates	Uruguay	Uzbekistan	Vanuatu	Viet Nam	Yemen	Zambia	Zimbabwe

Note: The categorization follows the World Investment Report, 2021b. Source: Composed by authors.

**Table A2.** Data descriptions and data sources.

Variable Name	Description	Data Source
M&A_number	Number of M&A deals	(World Investment Report 2021b)
Ln(Corona_case)	A natural logarithm of total COVID-19 cases (per million people)	(Our World in Data 2021)
Corona_death	Total COVID-19 deaths/Total COVID-19 cases (rate)	(Our World in Data 2021)
Ln(SDG)	A natural logarithm of SDG index (score 0–100)	(Sustainable Development Report 2020)
Ln(CPI)	A natural logarithm of Consumer Price Index (CPI)	(UNCTAD Stat 2021)
Ln(Per_capita)	A natural logarithm of GDP per capita (dollars at current prices)	(UNCTAD Stat 2021)

## References

- Abbas, Hafiz Syed Mohsin, Xiaodong Xu, Chunxia Sun, Atta Ullah, Samreen Gillani, and Muhammad Ahsan Ali Raza. 2021. Impact of COVID-19 pandemic on sustainability determinants: A global trend. *Heliyon* 7: e05912. [CrossRef]
- Agrawala, Shardul, Damien Dussaux, and Norbert Monti. 2020. *What Policies for Greening the Crisis Response and Economic Recovery?: Lessons Learned from Past Green Stimulus Measures and Implications for the COVID-19 Crisis*. OECD Environment Working Papers, No. 164. Paris: OECD Publishing. [CrossRef]
- Barcelo, Damia. 2020. An environmental and health perspective for COVID-19 outbreak: Meteorology and air quality influence, sewage epidemiology indicator, hospitals disinfection, drug therapies and recommendations. *Journal of Environmental Chemical Engineering* 8: 104006. [CrossRef]
- Bashir, Muhammad Farhan, Benjiang Ma, Bushra Komal, Muhammad Adnan Bashir, Duoqiao Tan, and Madiha Bashir. 2020. Correlation between climate indicators and COVID-19 pandemic in New York, USA. *Science of The Total Environment* 728: 138835. [CrossRef]

- Bhattacharya, Amar, and Nicholas Stern. 2020. *From Rescue to Recovery, to Transformation and Growth: Building a Better World after COVID-19*. London: Grantham Research Institute on Climate Change and the Environment. Available online: <https://eprints.lse.ac.uk/104540/> (accessed on 31 August 2021).
- Calabrese, Armando, Giampiero Forte, and Nathan Levialdi Ghiron. 2018. Fostering sustainability-oriented service innovation (SOSI) through business model renewal: The SOSI tool. *Journal of Cleaner Production* 201: 783–91. [CrossRef]
- Chiappinelli, Olga, Timo Gerres, Karsten Neuhoﬀ, Frederik Lettow, Heleen de Coninck, Balázs Felsmann, Eugénie Joltreau, Gauri Khandekar, Pedro Linares, Jörn Richsteina, and et al. 2021. A green COVID-19 recovery of the EU basic materials sector: Identifying potentials, barriers and policy solutions. *Climate Policy*, 1–19. [CrossRef]
- Cyrus, Elena, Rachel Clarke, Dexter Hadley, Zoran Bursac, Mary Jo Trepka, Jessy G. Dévieux, Ulas Bagci, Debra Furr-Holden, Makella Coudray, Yandra Mariano, and et al. 2020. The Impact of COVID-19 on African American Communities in the United States. *Health Equity* 4: 476–83. [CrossRef] [PubMed]
- Deng, Ping. 2009. Why do Chinese firms tend to acquire strategic assets in international expansion? *Journal of World Business* 44: 74–84. [CrossRef]
- Dowling, Michael, and Dieter Vanwalleghem. 2018. Gulf Cooperation Council cross-border M&A: Institutional determinants of target nation selection. *Research in International Business and Finance* 46: 471–89. [CrossRef]
- Erel, Isil, Rose C. Liao, and Michael S. Weisbach. 2012. Determinants of Cross-Border Mergers and Acquisitions. *The Journal of Finance* 67: 1045–82. [CrossRef]
- Facciola, Alessio, Pasqualina Laganà, and Gabriella Caruso. 2021. The COVID-19 pandemic and its implications on the environment. *Environmental Research* 201: 111648. [CrossRef]
- Hayakawa, Kazunobu, and Hiroshi Mukunoki. 2021. Impacts of COVID-19 on Global Value Chains. *The Developing Economies* 59: 154–77. [CrossRef]
- He, Wu, Zuopeng (Justin) Zhang, and Wenzhuo Li. 2021. Information technology solutions, challenges, and suggestions for tackling the COVID-19 pandemic. *International Journal of Information Management* 57: 102287. [CrossRef]
- Ho, Linh, and Christopher Gan. 2021. Foreign Direct Investment and World Pandemic Uncertainty Index: Do Health Pandemics Matter? *Journal of Risk and Financial Management* 14: 107. [CrossRef]
- Hu, Xiaoting, Ximing Yin, Zhanming Jin, and Jizhen Li. 2020. How Do International M&As Affect Rival Firm's Sustainable Performance?—Empirical Evidence from an Emerging Market. *Sustainability* 12: 1318. [CrossRef]
- Hutzschenreuter, Thomas, Ingo Kleindienst, and Michael Schmitt. 2012. Path-related empirical research on M&A-outcome: Review and research agenda. *Review of Managerial Science* 6: 375–405. [CrossRef]
- Hyun, Hea-Jung, and Hyuk Hwang Kim. 2010. The Determinants of Cross-border M&As: The Role of Institutions and Financial Development in the Gravity Model. *The World Economy* 33: 292–310. [CrossRef]
- IMF. 2021. Available online: [https://www.imf.org/external/datamapper/NGDP\\_RPCH@WEO/OEMDC/ADVEC/WEOORLD](https://www.imf.org/external/datamapper/NGDP_RPCH@WEO/OEMDC/ADVEC/WEOORLD) (accessed on 31 August 2021).
- Ioan, Batrancea, Rathnaswamy Malar Mozi, Gaban Lucian, Fatacean Gheorghe, Tulai Horia, Bircea Ioan, and Rus Mircea-Iosif. 2020. An Empirical Investigation on Determinants of Sustainable Economic Growth. Lessons from Central and Eastern European Countries. *Journal of Risk and Financial Management* 13: 146. [CrossRef]
- Kaya, Sema Kayapinar. 2020. Evaluation of the Effect of COVID-19 on Countries' Sustainable Development Level: A comparative MCDM framework. *Operational Research in Engineering Sciences: Theory and Applications* 3: 101–22. [CrossRef]
- Kooli, Chokri, and Melanie Lock Son. 2021. Impact of COVID-19 on Mergers, Acquisitions & Corporate Restructurings. *Businesses* 1: 102–14. [CrossRef]
- Kumar, Aishwarya, Puneet Kumar Gupta, and Ankita Srivastava. 2020. A review of modern technologies for tackling COVID-19 pandemic. *Diabetes & Metabolic Syndrome: Clinical Research & Reviews* 14: 569–73. [CrossRef]
- Li, Qiang. 2011. An Analysis of Motivations and Features in Chinese Enterprises' Cross-border M&A from Strategic-Asset-Seeking Perspective. *Journal of Beijing Technology and Business University (Social Science)* 26: 96–102. Available online: [https://en.cnki.com.cn/Article\\_en/CJFDTotal-BJSB201102014.htm](https://en.cnki.com.cn/Article_en/CJFDTotal-BJSB201102014.htm) (accessed on 31 August 2021).
- Liang, Yanze, Axèle Giroud, and Asmund Rygh. 2021. Emerging multinationals' strategic asset-seeking M&As: A systematic review. *International Journal of Emerging Markets* 16: 1348–72. [CrossRef]
- Lindén, Andreas, and Samu Mäntyniemi. 2011. Using the negative binomial distribution to model overdispersion in ecological count data. *Ecology* 92: 1414–21. [CrossRef] [PubMed]
- Liu, Jiangtao, Ji Zhou, Jinxi Yao, Xiuxia Zhang, Lanyu Li, Xiaocheng Xu, Xiaotao He, Bo Wang, Shihua Fu, Tingting Niu, and et al. 2020. Impact of meteorological factors on the COVID-19 transmission: A multi-city study in China. *Science of The Total Environment* 726: 138513. [CrossRef] [PubMed]
- Lyons, Nancy, and George Lăzăroiu. 2020. Addressing the COVID-19 crisis by harnessing Internet of Things sensors and machine learning algorithms in data-driven smart sustainable cities. *Geopolitics, History, and International Relations* 12: 65–71.
- Megahed, Naglaa A., and Ehab M. Ghoneim. 2020. Antivirus-built environment: Lessons learned from Covid-19 pandemic. *Sustainable Cities and Society* 61: 102350. [CrossRef] [PubMed]
- Mohideen, Mohamedazeem M., Seeram Ramakrishna, Sivaprasath Prabu, and Yong Liu. 2021. Advancing green energy solution with the impetus of COVID-19 pandemic. *Journal of Energy Chemistry* 59: 688–705. [CrossRef]

- Moon, H. Chang, Alan M. Rugman, and Alain Verbeke. 1995. The generalized double diamond approach to international competitiveness. In *Beyond the Diamond*. Bingley: Emerald Group Publishing Limited. [CrossRef]
- Moon, H. Chang, Alan M. Rugman, and Alain Verbeke. 1998. A generalized double diamond approach to the global competitiveness of Korea and Singapore. *International Business Review* 7: 135–50. [CrossRef]
- Naji, Hasan A. H., Qingji Xue, Ke Zheng, and Nengchao Lyu. 2020. Investigating the Significant Individual Historical Factors of Driving Risk Using Hierarchical Clustering Analysis and Quasi-Poisson Regression Model. *Sensors* 20: 2331. [CrossRef] [PubMed]
- Nguyen, Huy Will, Zhu Zhu, Young Hoon Jung, and Dong Shin Kim. 2021. Determinants of M&A acquisition premium: A social capital perspective. *Competitiveness Review: An International Business Journal*. [CrossRef]
- Our World in Data. 2021. Available online: <https://github.com/owid/covid-19-data/tree/master/public/data> (accessed on 24 July 2021).
- Pablo, Eduardo. 2009. Determinants of cross-border M&As in Latin America. *Journal of Business Research* 62: 861–67. [CrossRef]
- Pavlyshenko, Bohdan M. 2020. Regression approach for modeling COVID-19 spread and its impact on stock market. *arXiv arXiv:2004.01489*.
- Pradhan, Jaya Prakash. 2010. Strategic Asset-seeking Activities of Emerging Multinationals: Perspectives of Foreign Acquisitions by Indian Pharmaceutical MNEs. *Organizations and Markets in Emerging Economies* 1: 9–31. [CrossRef]
- Rao-Nicholson, Rekha, and Julie Salaber. 2016. Impact of the Financial Crisis on Cross-Border Mergers and Acquisitions and Concentration in the Global Banking Industry. *Thunderbird International Business Review* 58: 161–73. [CrossRef]
- Reddy, Kotapati Srinivasa, Vinay Kumar Nangia, and Rajat Agrawal. 2014. The 2007–2008 global financial crisis, and cross-border mergers and acquisitions: A 26-nation exploratory study. *Global Journal of Emerging Market Economies* 6: 257–81. [CrossRef]
- Rjoub, Husam, Mehmet Aga, Ahmad Abu Alrub, and Murad Bein. 2017. Financial Reforms and Determinants of FDI: Evidence from Landlocked Countries in Sub-Saharan Africa. *Economies* 5: 1. [CrossRef]
- Rossi, Stefano, and Paolo F. Volpin. 2004. Cross-country determinants of mergers and acquisitions. *Journal of Financial Economics* 74: 277–304. [CrossRef]
- Rousseau, Sandra, and Nick Deschacht. 2020. Public Awareness of Nature and the Environment During the COVID-19 Crisis. *Environmental and Resource Economics* 76: 1–11. [CrossRef]
- Scott, Roger, Milos Poliak, Jaromir Vrbka, and Elvira Nica. 2020. COVID-19 response and recovery in smart sustainable city governance and management: Data-driven Internet of Things systems and machine learning-based analytics. *Geopolitics, History and International Relations* 12: 16–22.
- Soares, Manuel A. D., Gabriela A. Silva, and Tiago FP Silva. 2020. Make-a-thon: A blueprint for SDG-driven innovation. In *ISPIM Conference Proceedings*. Virtual: The International Society for Professional Innovation Management (ISPIM), pp. 1–16. ISBN 978-952-335-466-1.
- Soni, Amit, Rabi N. Kar, and Niti Bhasin. 2019. Understanding the Paradigm Shift in Strategy of M&As in India in a Volatile Period Through Motive Analysis: Evidences from the IT Industry. *Global Business Review*. [CrossRef]
- Srivastava, Ankita, Raghvendra Kumar Sharma, and Arjun Suresh. 2020. Impact of Covid-19 on sustainable development goals. *International Journal of Advanced Science and Technology* 29: 4968–72.
- Strusani, Davide, and Georges V. Hounghonon. 2020. *What COVID-19 Means for Digital Infrastructure in Emerging Markets*; EMCompass No. 83. Washington, DC: International Finance Corporation. Available online: <https://openknowledge.worldbank.org/handle/10986/34306> (accessed on 31 August 2021).
- Sun, Sunny Li, Mike W. Peng, Bing Ren, and Daying Yan. 2012. A comparative ownership advantage framework for cross-border M&As: The rise of Chinese and Indian MNEs. *Journal of World Business* 47: 4–16. [CrossRef]
- Sustainable Development Report. 2020. Available online: <https://sdgindex.org/reports/sustainable-development-report-2020/> (accessed on 9 August 2021).
- Ting, Daniel Shu Wei, Lawrence Carin, Victor Dzau, and Tien Y. Wong. 2020. Digital technology and COVID-19. *Nature Medicine* 26: 459–61. [CrossRef]
- Uang, Shiao-Tsyr, and Cheng-Li Liu. 2013. The development of an innovative design process for eco-efficient green products. In *International Conference on Human-Computer Interaction*. Berlin/Heidelberg: Springer, pp. 475–83. [CrossRef]
- UNCTAD. 2021. Global Foreign Direct Investment Fell by 42% in 2020, Outlook Remains Weak. Available online: <https://unctad.org/news/global-foreign-direct-investment-fell-42-2020-outlook-remains-weak> (accessed on 13 March 2021).
- UNCTAD Stat. 2021. Available online: [https://unctadstat.unctad.org/wds/ReportFolders/reportFolders.aspx?sCS\\_ChosenLang=en](https://unctadstat.unctad.org/wds/ReportFolders/reportFolders.aspx?sCS_ChosenLang=en) (accessed on 23 July 2021).
- Van Zanten, Jan Anton, and Rob Van Tulder. 2020. Beyond COVID-19: Applying “SDG logics” for resilient transformations. *Journal of International Business Policy* 3: 451–64. [CrossRef]
- Ver Hoef, Jay M., and Peter L. Boveng. 2007. Quasi-poisson vs. negative binomial regression: How should we model overdispersed count data? *Ecology* 88: 2766–72. [CrossRef]
- Walsh, Patrick Paul, Enda Murphy, and David Horan. 2020. The role of science, technology and innovation in the UN 2030 agenda. *Technological Forecasting and Social Change* 154: 119957. [CrossRef]
- Wang, Jing. 2008. The macro determinants of M&A timing in China. *International Journal of Business and Management* 3: 141–46.
- Whitelaw, Sera, Mamas A. Mamas, Eric Topol, and Harriette GC Van Spall. 2020. Applications of digital technology in COVID-19 pandemic planning and response. *The Lancet Digital Health* 2: e435–e440. [CrossRef]

- World Investment Report. 2021a. Annex Table 05: Value of Net Cross-Border M&A Sales, by Region/Economy of Seller, 1990–2020. Available online: <https://unctad.org/topic/investment/world-investment-report> (accessed on 24 July 2021).
- World Investment Report. 2021b. Annex Table 07: Number of Net Cross-Border M&A Sales, by Region/Economy of Seller, 1990–2020. Available online: <https://unctad.org/topic/investment/world-investment-report> (accessed on 24 July 2021).
- Xie, Bo, Neil Charness, Karen Fingerman, Jeffrey Kaye, Miyong T. Kim, and Anjum Khurshid. 2020. When Going Digital Becomes a Necessity: Ensuring Older Adults' Needs for Information, Services, and Social Inclusion During COVID-19. *Journal of Aging & Social Policy* 32: 460–70. [CrossRef]
- Yan, Xingpei, and Zheng Zhu. 2021. Quantifying the impact of COVID-19 on e-bike safety in China via multi-output and clustering-based regression models. *PLoS ONE* 16: e0256610. [CrossRef] [PubMed]
- Yang, Xiaohua, Yi Jiang, Rongping Kang, and Yinbin Ke. 2009. A comparative analysis of the internationalization of Chinese and Japanese firms. *Asia Pacific Journal of Management* 26: 141–62. [CrossRef]
- Yu, Hong-tao. 2020. M&A Motivation and M&A Performance: A Test based on the Perspective of Saving Transaction Cost and Further Investment Demand. *Commercial Research* 62: 75. Available online: <https://www.cjournal.org.cn/EN/Y2020/V62/I6/75> (accessed on 31 August 2021).



Article

# The Evolution and Takeoff of the Ecuadorian Economic Groups

Ana Belén Tulcanaza-Prieto <sup>1,\*</sup> and Manuel Eugenio Morocho-Cayamcela <sup>2,†</sup><sup>1</sup> Escuela de Negocios, Universidad de Las Américas, UDLA, Vía a Nayón, Quito 170124, Ecuador<sup>2</sup> School of Mathematical and Computational Sciences, Yachay Tech University, Hda. San José s/n y Proyecto Yachay, Urcoquí 100119, Ecuador; mmorocho@yachaytech.edu.ec

\* Correspondence: ana.tulcanaza@udla.edu.ec

† These authors contributed equally to this work.

**Abstract:** An economic group is a collection of parent and subsidiary corporations that operates as a single economic organism under the same legislature of control. The decisions taken by the economic groups in any country are among the most influential factors that impact its market and the country's economic political scenario. This work studies the impact of the Ecuadorian economic groups from 2015 to 2019, where a historical peak of 300 economic groups was reached. However, the taxes representativeness of the Ecuadorian economic groups remained stable during the same period of analysis. We analyzed the financial and fiscal variables of the Ecuadorian ranking of firms, and detected the following of its economic groups: (i) They are still concentrating wealth despite the implementation of hard government policies to transparent the financial and economic information; (ii) They tend to compete in oligopolistic markets, given that their economic and financial decisions are interconnected with their family firms or consortium groups; (iii) They operate in a behavioral nature that follows a linear association between the total income, total assets, total equity, and total tax collection. We hope this work will serve as a future reference for researchers focused on the economic groups of Ecuador and Latin American countries.

**Citation:** Tulcanaza-Prieto, A. B.; Morocho-Cayamcela, M. E.. 2021. The Evolution and Takeoff of the Ecuadorian Economic Groups. *Economies* 9: 188. <https://doi.org/10.3390/economies9040188>

Academic Editor: Ștefan Cristian Gherghina

Received: 12 October 2021  
Accepted: 23 November 2021  
Published: 1 December 2021

**Publisher's Note:** MDPI stays neutral with regard to jurisdictional claims in published maps and institutional affiliations.



**Copyright:** © 2021 by the authors. Licensee MDPI, Basel, Switzerland. This article is an open access article distributed under the terms and conditions of the Creative Commons Attribution (CC BY) license (<https://creativecommons.org/licenses/by/4.0/>).

**Keywords:** economic groups; family firms; economic concentration; economic power; Latin America; Ecuador

## 1. Introduction

An economic group is defined as a conglomerate of firms that are grouped together by their financial capital (Navarro 1975). The economic groups of a given country can be articulated in agencies, associations, industry, banks, and commerce, granting them the possibility to be an articulated in blocks as well (Fierro 1991). These groups usually have interest in the majority of economic sectors in a country, creating new fields of investment. Peralta (2015) mentioned that there is a *bourgeois-tripod* in Latin America that integrates the agricultural, industrial, and commercial financial sectors. Marchán (2017) studied the economical behavior of Latin America during the 19th century and introduced the concept of *nation-state* to describe the Republic of Ecuador, where the political strategies have been always focused on the economic elites. The *nation-state* concept coined by the author is justified on the economical and financial integration of Ecuador, mainly based on the idea of an economy open to both exports and local production, enabling the *governability* of the country.

Historically speaking, Acosta (2006) reported that the concentration of economic power in Ecuador began just after the foundation of the Republic in 1830. The author defined the four periods of the economic history of Ecuador as (i) the surplus of the colonial era, (ii) the *primary-exporter* modality period, (iii) the period of industrialization and import substitution, and (iv) the period of modern economy. Most of the Ecuadorian elite groups have been, throughout history, concentrated in Quito, Guayaquil, and Cuenca. The pressure of these economic groups on the government decisions have been visible



across (i) the primary products exportation program (mainly for the coastal region), (ii) the manufacturing project for the north-central Andes region, and (iii) by the law of agricultural and industrial development from 1981. Cueva (1988) explained the economical and political history of Ecuador as the domination of the wealthy groups and the struggle for power between social classes. This domination process granted power to landowners, agro-exporters, and the bourgeoisie, furnishing a permanent economic power to the privileged classes. It is worth noting that the 70% of the Ecuadorian financial institutions that went bankrupt in the financial crisis of 1999 belonged to only 200 persons of the 5 largest economic groups (evinced the power of oligarchies in the country) (El Comercio 2010). Ever since, the inclusion of economic groups in the political and economic decisions of the Ecuadorian government has weakened the state, leading to a successive overthrow of presidents, an unexpected freeze of deposits (*banking holiday*), the devaluation of the local currency (Sucre), and the adoption of the American dollar (USD) as the official currency in 2000.

On the other hand, the economic groups in Latin America have shown small *risk-diversification*, compared to the international standards (Schneider 2013). This investment diversification ranges from the agro-export sector to the private financial sector. Lazzarini et al. (2008) referred that the Latin American economic groups are mostly integrated by families. The author stated that Latin America is living in the capitalism of family ties, which is sustained by the close and intertwined relationships between (i) the economy, (ii) politics, and (iii) the state. This triangular alliance has been managing the national and international market opportunities and local political economies. The study of the economic groups in Latin America intensified in the late 1950s (Garrido and Peres 1996), but its actual importance was boosted in the 1970s due to the protectionism of the economic groups by the industrialization and substitution of imports (Vanoni and Rodríguez 2017). Clear evidence of this phenomena was the several economic concentration studies in Chile (Dahse 1981; Lagos 1960), Colombia (Misas 1975; Silva 1977; Wilches and Rodríguez 2016), Nicaragua (Strachan 1976), and Ecuador (Centro de Estudios y Difusión Social (CEDIS) 1986; Fierro 1991 2019; Minaya 2006; Navarro 1975; Pástor 2015; Solano and Tobar 2017; Tobar and Solano 2017; Tulcanaza 2010; Tulcanaza-Prieto 2018; Tulcanaza-Prieto and Morocho-Cayamcela 2018; Vanoni and Rodríguez 2017). Moreover, the economic groups in Latin America have revealed six standard features: (i) they obey their family's ties, (ii) they are influenced by the inheritance of the colony, (iii) their production is diversified, (iv) they are technology consumers, not producers, (v) they are structured by subsidiaries, and (vi) they are usually intermediaries of multinationals.

In this study, we have empirically examined the financial and fiscal variables of the Ecuadorian economic groups, using the rankings of firms provided by the Servicio de Rentas Internas del Ecuador (SRI) from 2016 to 2020 (data correspond to 2015 to 2019) (Servicio de Rentas Internas del Ecuador 2021). Our results show that the number of Ecuadorian economic groups increased during the period of 2015–2019. However, their contribution on the Ecuadorian fiscal variables remained stable over the period of study. Moreover, we have proven the linear association between (i) the total income, (ii) the total assets, and (iii) the total equity-to-tax collection of the economic groups under study. The database incorporates the most up-to-date data from the Ecuadorian economic groups from the last 5 years. Our results identified that the regulator entities and policymakers are the key actors to establish conditions to avoid the economic concentration in the country. Therefore, their role is to monitor the business mergers or the industry strengthening, using a deeper analysis in the short-, medium-, and long-term to identify the possible collusion and fusion risks of the market.

Our manuscript contributes to the literature since the study period corresponding to 2015–2019 shows that the entry of new economic groups is increasing. Only between 2015 and 2019 were 175 Ecuadorian economic groups incorporated, which indicates that the government regulations have begun to be more transparent in the presentation of economic groups' relationships between the parent company and its subsidiaries, exhibiting that

the business environment is constantly expanding and the main actors in the dynamics of globalization continue to be the large industries and financial groups, which serve as a model for small- and medium-sized enterprises. It should also be noted that the research is timely, given the contribution to the gross domestic product (GDP) of the Ecuadorian economic groups. The trend of analysis of the Ecuadorian economic groups is developed in this article. Basically, with a descriptive approach, we are able to understand how the Ecuadorian economic groups participate in the local environment and contribute by taxes to the national economy.

The remaining of the article is organized as follows: Section 2 presents the literature review regarding the formation of economic groups in Ecuador; Section 3 presents our research methodology; Section 4 reveals the empirical findings and discusses the results; and finally Section 5 highlights the conclusions and offers recommendations and research directions for future researchers.

## 2. Literature Review

### 2.1. The Establishment and Control of the Ecuadorian Economic Concentration

The Ecuadorian market can be understood as the place where the suppliers and demanders of goods and services execute their transactions. This market structure allows a deep analysis of the economic and operational establishment of the industry, stimulating the markets to increase their efficiency. In the Ecuadorian market, the number of suppliers and demanders have determined the degree of concentration of the industrial economy, which is measured by the number of firms and their similarity (Furió and Alonso 2008). Under equal conditions, as the number of firms increases, the market concentration decreases, revealing a negative relationship between both variables. The degree of market concentration is also associated with the business' volume and the number of workers. The business' volume is linked to the market share (i.e., the relationship between the firm's sales or production and the same industry variables), and the number of workers refers to the technical and operational collaborators involved in that business. However, this ratio does not always constitute a good proportion since it also depends on the line of business, the characteristics of the economic activity, and the technological level of goods and services. Table 1 shows the market structure according to the number of suppliers and demanders. The maximum degree of market concentration is the pure monopoly, contrary to the perfect competition, which is an economic structure with several suppliers and demanders.

**Table 1.** Market structure according to the number of suppliers and demanders.

Number of Demanders	Number of Suppliers		
	One	Few	Many
One	Bilateral monopoly	Partial monopsony	Monopsony
Few	Partial monopoly	Bilateral oligopoly	Oligopsony
Many	Pure monopoly	Oligopoly	Perfect competition

Source: Own elaboration based on the information obtained from Frank (2005).

Article 334, numeral 1, of the *Constitución de la República del Ecuador* (2008) states that the government must avoid the concentration or hoarding of the productive resources, reducing the presence of monopolies and oligopolies. Moreover, the *Superintendency of Control of the Power of Market* and the *Ley Orgánica de Regulación y Control del Poder de Mercado* (2011) determine whether an operation of economic concentration can be created or modified, providing the attribution to deny the concentration transaction or determine its conditions. The economic operators involved in economic concentration operations must inform the superintendency when the volume of total business in Ecuador exceeds the amount established by the board of regulation. The superintendency then determines, using a detailed study, if the concentration is authorized, denied, or subordinated, in order to avoid the overall market affectation.

The analysis of the economic concentration has changed during the last decade. For instance, in the 1970s, the analysis focused on the relationship of power between firms and the establishment of economic groups, whereas in the 2010s, its perspective was focused on the administrative capabilities and the corporate governance of firms and economic groups (Manosalve 2015; Tulcanaza-Prieto et al. 2020). A global economic concentration involves hierarchical capitalism, which studies the relationship between the firm's development, labor market, and capital markets (Schneider 2013). In Latin America, this type of capitalism is predominant, in part due to the fragmentation of labor markets and deficiencies in the educational systems, but also due to the reduced qualification of the workforce, which mitigates the investment in research and development (Tulcanaza-Prieto and Lee 2018).

Conclusively, there are two types of concentration that can be identified, a horizontal and a vertical one. The horizontal concentration is usually called *side* or *wide* concentration, and includes the set of firms that work on the same production stage to scale the operation process, reducing the price of raw materials through a wholesale mechanism (Robinson 1957). On the other hand, firms work in different successive production stages in the vertical concentration, including the value-chain in the transformation of raw material into the final product. However, this integrated process is linked to the establishment and propagation of monopolies, which also generate an upward integration, securing the supply of raw material for entrepreneurs, and a downward integration, providing market stability through production (Tulcanaza-Prieto and Lee 2018).

## 2.2. The Development and Integration of Ecuadorian Economic Groups

The definition of economic groups were developed by the economist and academic Francesco Vito during the Great Depression in 1929 (Vito 1935). This definition was linked with the corporate theory and political economy as an alternative to the classical and neoclassical economic theories (Losas 2005). In Ecuador, article 5 of the *Reglamento para la Aplicación de la Ley de Régimen Tributario Interno (LORTI)* defined an economic group as the set of individuals and firms, national or foreign, which directly or indirectly own 40% (or more) of the shareholding on other firms (Servicio de Rentas Internas del Ecuador 2015). An economic group can be easily formed when the owner(s) controls several firms, makes financial decisions, and defines the investment policies of the economic surplus (Dahse 1981). Moreover, a group can be structured by a family, friendship, or any other business bond (Leff 1978). It can also be integrated by different companies of diverse economic sectors that only share the administrative and financial control, corporate governance plan, or property management strategies (Anaya 1990). The integration of Ecuadorian economic groups has been impelled by market failures, such as business' information asymmetry, agency problems, institutional immaturity, or high transaction costs. Therefore, the economic groups act as intermediary institutions to join bidders and demands in the same place, facilitating transactions to organizations and business networks (Chavarín 2011). These intermediary institutions are the response to the economic development strategy driven by the local government (Guriev and Rachinsky 2005; Khanna and Yafeh 2007).

Among the main characteristics of the economic groups, we can distinguish the productive conglomeration, a limited separation of ownership and control between firms, and the transversal integration of the financial sector (Leff 1978). Schneider (2013) discussed that the economic groups influence the institutionality and the political economy of a country, given their technology innovation, skills development, and interaction with the political environment.

### A Brief History of the Research Efforts on the Ecuadorian Economic Groups

The Ecuadorian economy has been studied since the Republic was established. Several research efforts have found a strong dependence between the Ecuadorian economy and the international market and investments. Regarding the foreign investments, and since family groups have strong links with foreign capital, they have been investing with firms from other countries as well. In addition, the productive branches have been controlled

by few families and several firms, which regulate more than half of the national market (Fierro 1991).

During the 1970s, the Ecuadorian economic concentration was centralized on foreign economic groups, with low national capital and with the oil exportation as its major economic activity. At that time, *Guayaquil* and *Filantrópica* were the two family supergroups, which concentrated the economic and financial decisions of the country and excluded new participation in the business (Navarro 1975). Moreover, the powerful economic classes were the ones that distributed the surplus originated in the centralization and capital concentration (Centro de Estudios y Difusión Social (CEDIS) 1986). During the 1980s, the country experienced a monopolization as a result of the creation of conglomerates, accumulation, vertical and horizontal integrations, and diversification. In the same decade, the Ecuadorian productive capital was grounded in the agricultural sector, specifically in agricultural products and primary products that represented the base of the country's economy. For instance, the *cocoa boom* emerged between the period of 1880 to 1920, while the *banana boom* was exploited during the period of 1948 to 1965, allowing the accumulation of wealth and the appearance of one of the most influential economic groups in Ecuador, *Grupo Noboa*; this was associated with international capitals from transnationals, such as *United Fruit* and *Standard Fruit*. Navarro (1975) is one of the pioneer researchers that studied the behavior of the economic groups in Ecuador. He is recognized for (i) having measured the high levels of economic concentration in Ecuador for the first time, (ii) having recognized the economic groups in Ecuador as family clusters, which control a significant number of firms, (iii) having stated that a small number of families were the main actors in the economic dynamic and economic activities in Ecuador, and (iv) having showed that Ecuadorian firms that appear to be independent behave in the same way as a family economic group when they serve the same shareholder. However, Navarro (1975) dedicated his life to studying the economic concentration based on family groups, but not analyzing their impact on the Ecuadorian economy. Similarly, the *Center of Studies and Social Broadcasting of Ecuador* identified the most important monopolies in the country. They analyzed the levels of concentration and capital centralization of these groups in different branches of the Ecuadorian economy (Centro de Estudios y Difusión Social (CEDIS) 1986). On the other side, Fierro (1991) identified the economic areas where the economic groups are not only consolidated, but also generating oligopolistic or monopolistic opportunities. Fierro (1991) showed that a small number of firms that belonged to a specific economic group concentrated a significant level of the national sales. Other previous studies also confirmed the relationship between the amount of sales of firms and the prevalence of economic concentration (Cañas 2015; EKOS 2012; Pástor 2015; Unda and Bethania 2010).

Centro de Estudios y Difusión Social (CEDIS) (1986) classified the Ecuadorian economic groups as economic elites that control firms and operate in more than one city, mainly located in the provinces of Pichincha, Guayas, and Azuay. It was also proved that when those economic elites are linked to financial institutions, they grant them several advantages, such as the facilitation of obtaining credits with preferential interest rates (Centro de Estudios y Difusión Social (CEDIS) 1986; Fierro 1991). Furthermore, the authors explained that the economic groups in Ecuador have access to the main distribution, transportation, and commercialization chains, evincing a perfect control of the entire production processes inside the country. Solano and Tobar (2017) exposed that the economic groups represented about the 50% of the Ecuadorian GDP during 2015. Moreover, the Ecuadorian economic groups are linked to the management of the national media and banking system; for instance, the largest Ecuadorian bank is part of one of the most important economic groups. Tobar and Solano (2017) showed that the link between the Ecuadorian banking system and the corporate sectors is a key factor in the development of the economic groups and economic concentration. The authors debated that, (i) in the majority of the cases, the economic power groups have obtained financial support from bank allies, leveraging their corporate growth, and (ii) proved the significant positive correlation (at the 1% level) between the credit offered by the financial system, and the

incomes generated by production units in the city of Cuenca. Finally, [Fierro \(2019\)](#) showed that the divorce between financial institutions and investors in the media sector might decrease the conflict of interest between firms.

Conclusively, despite all the legal control and all the technological efforts to stop the formation of economic concentration in Ecuador, the presence of economic groups and important oligopolies is evident in the country.

Therefore, the hypothesis of this study can be summarized as follows.

**Hypothesis 1.** *The number of Ecuadorian economic groups exploited during the period from 2015 to 2019. However, their contribution on the Ecuadorian fiscal variables have remained stable.*

### 3. Data Source and Methodology

The information from the economic groups in Ecuador is available through request to the Ecuadorian tax control entity ([Servicio de Rentas Internas del Ecuador 2020](#)). The tax control entity is in charge of compiling and publishing information of this nature, which is considered an effective and transparent tool to trace the trajectory and behavior of the Ecuadorian economic groups.

We analyzed the transcendental financial and fiscal variables from the Ecuadorian economic groups in the following periods:

- (a) 2015–2019 (financial and fiscal variables);
- (b) 2016–2020 (ranking of the economic groups).

We included the composition and financial behavior of the economic groups, and their contribution to the Ecuadorian macroeconomic variables. The information collected from the register of economic groups, corresponds to the most recent database published by [Servicio de Rentas Internas del Ecuador \(2021\)](#). However, the report from 2017 is not available through the server; thus, the exclusion of this year in our study was beyond our reach. The total sample consists of 1.028 observations of the Ecuadorian economic groups. We also computed the correlation coefficients of the total tax collected by the economic groups, and their association with the total income, total assets, and total equity. We assume a positive Pearson correlation coefficient, given that the independent variables (i.e., total income, total assets, and total equity) have been proved to be linearly positively related with the dependent variable (i.e., tax collected) ([Tobar and Solano 2017](#); [Tulcanaza-Prieto 2018](#)).

To prove our hypothesis, the methodology of the study includes (i) descriptive statistics, and (ii) a correlation analysis of the financial and fiscal variables from the Ecuadorian economic groups. All variables employed in this study are described in [Table 2](#).

**Table 2.** Financial and fiscal variables of the study.

Variables	Formula / Description
Total Assets	Liabilities + Total Equity
Total Equity	Total Assets – Liabilities
Total Income	Revenue – Cost of goods sold
Income Tax	(Taxable base <sup>a</sup> – returns – discounts – costs – all deductions) * 25%
Tax Burden	(Income Tax/Total Income) * 100
Total National Net Tax Collection	Total Tax Collection - credit notes – compensations – returns
Total Tax Collection	Sum of all Ecuadorian taxes <sup>b</sup>

Note: <sup>a</sup> composed by ordinary and extraordinary taxed income, <sup>b</sup> includes: (1) income tax collected, (2) value added tax, (3) tax on special consumption, (4) environmental promotion tax, (5) motor vehicle tax, (6) currency outflow tax, (7) abroad assets tax, (8) RISE, (9) royalties, patents, and mining conservation profits, (10) contribution for comprehensive cancer care, (11) one-time and temporary contribution, (12) interest for tax delay, (13) tax fines, and (14) other income. Source: Own elaboration based on [Servicio de Rentas Internas del Ecuador \(2020\)](#).

We have included the following analysis to verify our hypothesis:

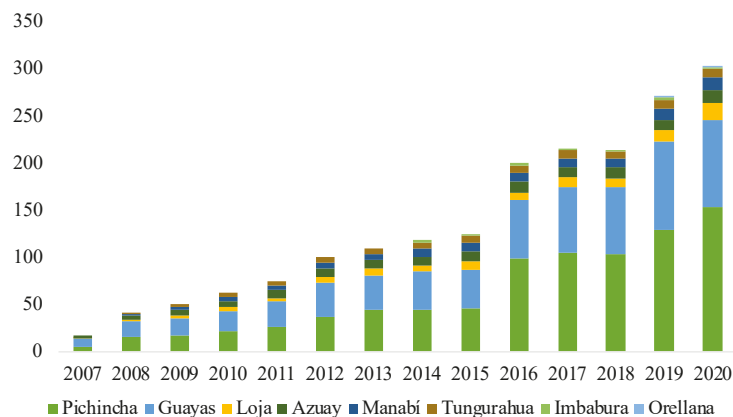
- (a) A graphic analysis of the evolution of the Ecuadorian economic groups, and the evolution of the most representative macroeconomic and fiscal variables of Ecuador.

This analysis establishes the representativeness of the Ecuadorian economic groups in the local economy.

- (b) A comparative analysis of the composition of the Ecuadorian economic groups, and the evolution of their financial and fiscal variables. This analysis compares figures from 2015 to 2019 to determine if the Ecuadorian economic groups have increased over time.
- (c) A descriptive analysis of the tax burden of the Ecuadorian economic groups to showcase the amount of paid taxes (considered as a proportion of the total income) in a specified period.
- (d) An analysis of the evolution of the top-10 Ecuadorian economic groups (according to their size and tax collection). This analysis explains the tax representativeness of the top 10 Ecuadorian economic groups vs. all the remaining economic groups and compared the outcome with the total national net tax collection. Moreover, the analysis of the Ecuadorian economic groups includes the contribution on the national net tax collection to verify if their representativeness have remained stable over time.
- (e) A correlation analysis between the financial variables of the Ecuadorian economic groups, and the total tax collection to prove the linear association between variables.

#### 4. Results and Discussion

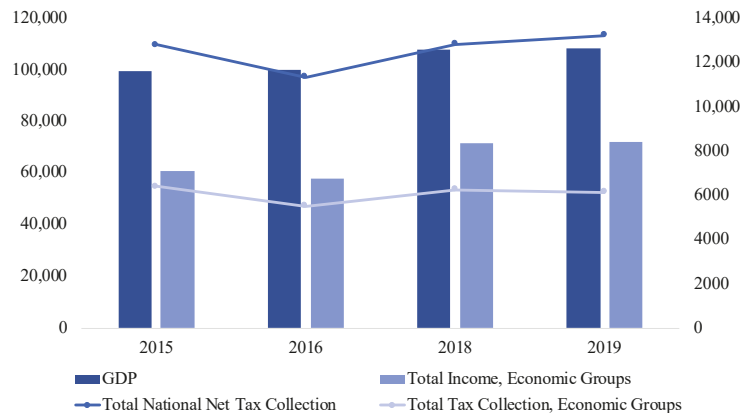
Figure 1 illustrates the evolution of the Ecuadorian economic groups from 2007 to 2020. Specifically, in the period of our analysis, we found an increase of 140.0% of the number of economic groups in Ecuador, raising from 125 (2015) to 300 (2020) economic groups. The provinces of Pichincha and Guayas concentrated an average of 79.3% of economic groups from 2015 to 2020, which denotes the poles of concentration in the provinces with the highest economic growth in Ecuador. The Andes region (provinces of Azuay, Imbabura, Loja, Pichincha, and Tungurahua) showed the highest agglutination of economic groups (on average 62.7%), while the economic groups located in the coastal provinces (Guayas and Manabí) represented an average of 37.2%. The province of Orellana in the Amazon region showed the presence of one economic group during the period of 2019–2020. Moreover, from 2015 to 2016, we found the most significant increase in the number of economic groups, growing from 125 to 200. [Vanoni and Rodríguez \(2017\)](#) explained the raise of 60.0% in the number of economic groups by the implementation of most efficient business strategies.



**Figure 1.** Evolution of the Ecuadorian Economic Groups. Source: Own elaboration based on the data collected from [Servicio de Rentas Internas del Ecuador \(2020\)](#).

Figure 2 shows us the most important macroeconomic and fiscal variables from 2015 to 2019 (excluding 2017 given the absence of information on the data source). The total income of economic groups represented on average 63.0% of the gross domestic product

(GDP) from 2015 to 2019. Likewise, the total national net tax collection, and the total tax collection of economic groups, implied on average 12.1%, and 5.9% of the Ecuadorian GDP, respectively. The total tax collection of economic groups represented on average the 48.5% of the total national net tax collection.



**Figure 2.** Evolution of macroeconomic and fiscal variables (measured in USD millions). Note: Information from 2017 was not available on the data source. Source: Own elaboration based on the data obtained from [Servicio de Rentas Internas del Ecuador \(2020\)](#) and [Banco Central del Ecuador \(2021\)](#).

Table 3 displays the composition of the Ecuadorian economic groups using rankings from 2017 to 2020, as provided by the [Servicio de Rentas Internas del Ecuador \(2021\)](#). Note that in 2017, there were 215 Ecuadorian economic groups with 7126 members; which were integrated by 84.4% of national and foreign firms, and 15.6% from natural and foreign individuals. The economic groups increased by 39.5% during 2020, which means there were 300 economic groups, which were integrated by 9,121 members, represented by 7712 national and foreign firms (84.6% of members of economic groups) and 1409 natural and foreign individuals (15.4% of total members). Moreover, 433 and 453 members were located in *tax havens* during 2017 and 2020, respectively, while 307 and 393 members of economic groups were related to off-shore firms (i.e., *Panama Papers* records) in the same period. Tax havens are linked to the international financial system and globalization ([Iturralde 2017](#)). Tax havens are also associated with the expansion and concentration of economic groups, which increase their economic and political power by the evasion or elusion of taxes, moving their capitals to countries or cities with tax havens. The economic group Juan Eljuri is the most visible group associated with tax havens and offshore firms, which represented 9.9% and 10.7% of the total economic groups domiciled in tax havens and offshore firms, respectively ([Servicio de Rentas Internas del Ecuador 2020](#)). Furthermore, the number of members of economic groups related to financial institutions increased from 15 to 46 from 2017 to 2020, while there was an increase of 17.0% in the number of members associated with media entities. [Navarro \(2006\)](#) advocated that the media is a *factual power*, given that it provides stability to the government. This factual power has influence in economic power, political permanency, and social response. Therefore, he concluded that the media and financial institutions might be considered a new economic group.

**Table 3.** Composition of Ecuadorian economic groups.

Detail	Ranking 2017	Ranking 2020
Number of economic groups	215	300
Number of members of the economic group	7126	9121
Number of members domiciled in tax havens	433	453
Number of members as offshore firms (Panama Papers) <sup>a</sup>	307	393
Number of members related with financial institutions	15	46
Number of members related with media entities	47	55

Note: <sup>a</sup> Panama Papers are related to members of economic groups which have been identified in the records of Panama Papers, website: <https://panamapapers.icij.org>. Source: Own elaboration based on the information provided by the *Servicio de Rentas Internas del Ecuador* (2020).

Table 4 exhibits the evolution of the financial and fiscal variables of the Ecuadorian economic groups from 2015 to 2019. The income tax grew 27.5%; however, the total tax collection decreased in 4.3%, varying from USD 6.394 million (2015) to USD 6.121 million (2019). The total income, total assets, and total equity increased by 17.8%, 36.8%, and 37.0%, respectively. The effective tax rate, computed by the ratio between income tax and total income, was 2.3% in 2015 and 2.5% in 2019, meaning that for every USD 100 that the Ecuadorian economic groups earned, they paid around USD 2.3 and USD 2.5 in 2015 and 2019, respectively.

**Table 4.** Financial and fiscal variables of Ecuadorian economic groups (in USD millions).

Detail	2015	2019	Variation	
Income Tax	1389	1772	382	27.5%
Total Tax Collection	6394	6121	−273	−4.3%
Total Income	60,903	71,744	10,841	17.8%
Total Assets	95,214	130,262	35,048	36.8%
Total Debt	N.A.	1234	1234	
Total Equity	35,206	48,216	13,009	37.0%

Note: Total debt is not reported for 2015 (N.A.). Source: Own elaboration based on *Servicio de Rentas Internas del Ecuador* (2020).

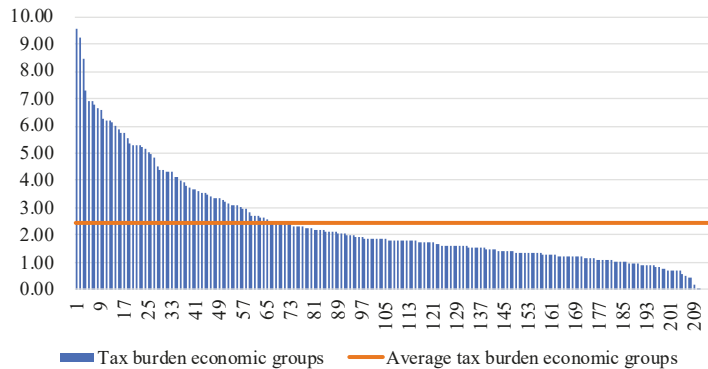
Table 5 and Figure 3 portray the tax burden of the Ecuadorian economic groups. The tax burden is calculated by the ratio between the income tax and the total income of each economic group. The tax burden showed a decrease of 5.1%, changing from 2.42 (2015) to 2.29 (2019). Its median value decreased by 10.5%, while its standard deviation value increased by 0.34 units, showing more dispersion and risk in the distribution of the tax burden during 2019 compared to 2015. The tax burden heavily depends on the productive activity, profit (depending on the economic sector), and the taxes according to the firm size and industry. Therefore, the tax burden does not necessarily show an increase in the profit of firms, but rather, it represents the productive stage of economic groups (*Revista Líderes* 2017). The highest tax burden in 2015 is 9.56 units represented by Grupo Degfer, while Nuevo Rancho Nuransa showed the highest tax burden in 2019 with 16.17 units.

**Table 5.** Descriptive statistics of tax burden of Ecuadorian economic groups.

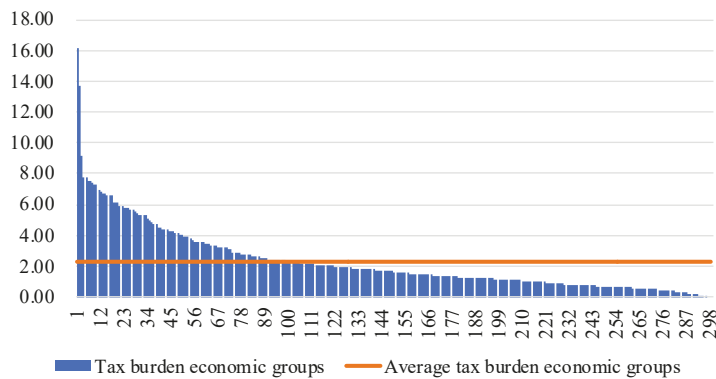
Year	Average Tax Burden	Median	Standard Deviation	Maximum
2015	2.42	1.83	1.78	9.56
2019	2.29	1.64	2.11	16.17

Source: Own elaboration based on the data from *Servicio de Rentas Internas del Ecuador* (2020).





(a) Year 2015



(b) Year 2019

**Figure 3.** Tax burden of Ecuadorian economic groups related to the income tax from the years (a) 2015, and (b) 2019. Source: Own elaboration based on [Servicio de Rentas Internas del Ecuador \(2020\)](#).

Table 6 shows the top 10 Ecuadorian economic groups classified by their size. Six out of the ten largest economic groups have maintained their position in the top 10 when comparing 2016 to 2020. The total asset of the top ten economic groups in 2020 were USD 53.145 million, with a few financial institutions (Banco Pichincha, Banco de Guayaquil, Produbanco, and Banco Bolivariano CA) concentrating the 60.9% of the total assets of the top 10 ranking.

Table 7 presents the top 10 Ecuadorian economic groups classified by their tax collection using the ranking 2016–2020. Eight out of the ten economic groups have maintained their position in the top ten ranking, comparing 2016 to 2020. If we compare Tables 6 and 7, we can notice that five economic groups were present in both rankings (classified by size and tax collection) during 2020. The total tax collection of the top 10 economic groups represented 43.8% and 44.7% of the total tax collection of the Ecuadorian economic groups for 2015 and 2019, respectively. What is more, the *representativeness* of the total tax collection of the top 10 economic groups over the total national net tax collection varied from 21.9% to 20.8% from 2015 to 2019. Ultimately, the total tax collection of economic groups represented at least half of the total national net tax collection.

**Table 6.** Top 10 Ecuadorian economic groups per year, classification according to their size.

Rk. 2020	Rk. 2019	Rk. 2017	Rk. 2016	Variation 2016–2020	Economic Group
1	1	1	1	0	Banco Pichincha
2	2	3	2	0	Almacenes Juan Eljuri
3	3	4	4	1	Corporación Favorita
4	4	2	5	1	Schlumberger del Ecuador
5	7	7	8	3	Banco de Guayaquil
6	6	6	7	1	Produbanco
7	5	5	3	−4	OCP Ecuador
8	8	10	11	3	Holdindine Corporación Industrial y Comercial
9	9	11	10	1	Corporación El Rosado
10	10	12	12	2	Banco Bolivariano C.A.
11	12	8	6	−5	Claro
17	17	9	9	−8	Industria Pronaca

Note: Ranking of 2018, which contains information of 2017, was not available on the SRI webpage. Source: Own elaboration based on [Servicio de Rentas Internas del Ecuador \(2020\)](#).

Table 8 shows the principal financial variables of the ranking between 2016 and 2020 of the top 10 Ecuadorian economic groups classified by their size. Among our findings, it is worth mentioning that (i) the income contribution of the ten largest economic groups to the total income of all Ecuadorian groups was 25.5% and 22.4% in 2015 and 2019, respectively; (ii) the total assets grew by 35.5% and 36.8% for the top ten economic groups and total economic groups from 2015 to 2019, respectively; (iii) the total assets of the top ten economic groups represented 41.3% and 40.8% of the total assets of total economic groups during 2015 and 2019, respectively; and the total equity of the ten largest economic groups varied in 38.0%, increasing from USD 11.701 million in 2015 to USD 16.145 million in 2019. The increase represents 33.2% (2015) and 33.5% (2019) when compared to the total equity of the economic groups.

Lastly, Table 9 offers the linear correlation coefficients of the most important financial variables and the total tax collection. Total income, total assets, and total equity revealed a significant positive association at the 1% level with the total tax collection. The highest correlation coefficient is obtained between the total income and the total tax collection, showing coefficient values of 0.808, 0.784, 0.837, and 0.793 for 2015, 2016, 2018, and 2019, respectively. Most of the correlation values themselves were higher than 0.700, which means that the *multicollinearity* problem might arise in the regression analysis, given that the dependent variable is strongly associated with all independent variables, verifying one more time that the total tax collection directly depends on the total income, total assets, and total equity.

Table 7. Top 10 Ecuadorian economic groups per year, classification according to tax collection.

Ranking 2020	Ranking 2019	Ranking 2017	Ranking 2016	Variation 2016–2020	Economic Group	2015	2016	2018	2019
1	1	1	1	0	Banco Pichincha	664,261,405	498,739,821	607,395,054	667,872,343
2	2	2	2	0	Dinadec	350,974,788	352,100,364	390,791,027	427,107,715
3	3	3	4	1	Produtbanco	264,294,993	222,306,816	274,261,174	299,941,296
4	5	7	8	4	Banco de Guayaquil	191,614,215	175,517,131	222,582,890	234,359,513
5	6	6	7	2	Banco Bolivariano C.A.	197,354,449	180,440,219	206,430,145	209,149,340
6	7	5	3	-3	Claro	315,489,121	185,073,552	186,042,898	190,495,917
7	4	9	9	2	Almacenes Juan Eljuri	183,909,249	157,333,985	229,738,403	190,328,750
8	8			-8	Banco Internacional	185,639,529	182,165,876		
9	9			-9	Arca Ecuador	183,298,823	168,714,088		
10	10	10	10	0	Citibank N. A., Ecuador	179,366,431	144,775,146	179,592,586	166,635,702
		4	5	5	Itabsa	239,723,714	205,429,092		
		8	6	6	Schlumberger dl Ecuador	210,851,012	157,866,766		
(a) Total Tax Collection, Top 10 Economic Groups						2,797,839,378	2,279,582,892	2,665,772,529	2,736,770,540
(b) Total Tax Collection, Economic Groups						6,393,835,744	5,499,929,764	6,256,788,523	6,120,831,840
(c) Total National Net Tax Collection						12,755,076,181	11,309,307,282	12,809,502,107	13,180,846,182
(a)/(b)						43.8%	41.4%	42.6%	44.7%
(a)/(c)						21.9%	20.2%	20.8%	20.8%
(b)/(c)						50.1%	48.6%	48.8%	46.4%

Note: Ranking of 2018, which contains information of 2017, was not available on the SRI webpage. Source: Own elaboration based on [Servicio de Rentas Internas del Ecuador \(2020\)](#).

Table 8. Financial variables, top 10 Ecuadorian economic groups per year, classification according to their size (in USD millions).

Economic Group	Total Income					Total Assets					Total Equity					
	2015	2016	2018	2019	2015	2016	2018	2019	2015	2016	2018	2019	2015	2016	2018	2019
Banco Pichincha	2055	2102	2387	2727	13,203	14,484	16,580	17,892	2658	2601	3477	3681	2601	2601	3477	3681
Almacenes Juan Eljuri	1894	1813	3106	2740	4294	4575	6506	6418	1244	1287	2035	1947	1287	1287	2035	1947
Corporación Favorita	2697	2508	2880	2919	2132	2245	2867	3344	1567	1690	2154	2315	1690	1690	2154	2315
Schlumberger del Ecuador	1297	2027	1724	1834	3137	4537	3968	3617	1546	1966	2397	2306	1966	1966	2397	2306
Banco de Guayaquil	484	467	525	602	3840	4190	4570	5334	644	670	727	792	670	670	727	792
Produbanco	342	357	533	609	3905	4324	4935	5337	617	623	539	571	623	623	539	571
OCP Ecuador	1877	1661	2013	1579	3720	3749	3771	3212	1593	1455	2004	1455	1455	1455	2004	1455
Holdingdine		1019	965	1030		2125	2185	2325		1693	1889	2031	1693	1693	1889	2031
Corporación El Rosado	1591		1605	1657	1635	3565	1655	1838	520	523	454	477	523	523	454	477
Banco Bolívariano C.A.	1542	289	342		1969	1968	3828		521	555	571		521	555	571	
Claro	1754	1655			1469	1523			791	845			791	845		
Industria Pronaca																
(a) Total Top 10	15,533	15,057	16,027	16,039	39,304	43,720	50,603	53,145	11,701	13,386	16,199	16,145	13,386	13,386	16,199	16,145
(b) Total Economic Groups	60,903	57,994	71,455	71,744	95,214	102,044	122,032	130,262	35,206	36,479	46,525	48,216	36,479	36,479	46,525	48,216
(a)/(b)	25.5%	26.0%	22.4%	22.4%	41.3%	42.8%	41.5%	40.8%	33.2%	36.7%	34.8%	33.5%	36.7%	36.7%	34.8%	33.5%

Note: Ranking of 2018, which contains information of 2017, was not available on the SRI webpage. Source: Own elaboration based on [Servicio de Rentas Internas del Ecuador \(2020\)](#).

**Table 9.** Pearson correlation coefficients, Ecuadorian economic groups.

Financial Variables vs. Total Tax Collection	2015	2016	2018	2019
Total Income	0.808 ***	0.784 ***	0.837 ***	0.793 ***
Total Assets	0.537 ***	0.544 ***	0.736 ***	0.698 ***
Total Equity	0.677 ***	0.716 ***	0.802 ***	0.772 ***

Note: Information of 2017 was not available in the SRI webpage, \*\*\* indicates statistical significance at the 1% level. Source: Own elaboration based on [Servicio de Rentas Internas del Ecuador \(2020\)](#).

## 5. Conclusions

We have seen how a small cluster of family groups controls the economic power in Ecuador. Those clusters, also called economic groups, have influenced the Ecuadorian market and politics, in part due to their economic power, but also due to their financial, communicational, and political concentration. We have verified that the economic groups in Ecuador manage higher concentrations of wealth despite the implementation of government policies for transparency of the financial and economic information of economic groups. Our findings are aligned with previous research studies that showed a significant positive linear association between total tax collection, total income, total assets, and total equity during the period of 2015–2019. Furthermore, our analysis discloses that Ecuadorian economic groups tend to compete in oligopolistic markets, given that their economic and financial decisions are interconnected with their family firms or consortium groups. We have detected an exponential growth of the economic groups in Ecuador, in view of the fact that the number of economic groups take off from 17 groups in 2007 to 300 in 2020. Notwithstanding, we predict a stagnation of the economic groups during the post-COVID-19, mainly due to the contraction of 7.8% in the GDP that affects home and government consumption, investment, and exports. For future studies, we recommend conducting an analysis for economic groups, using the industry integration indexes. We would also like to suggest incorporating the labor market characteristics as a crucial variable for the development and analysis of economic policies. Similarly, we recommend focusing on the longitudinal analysis and financial trend indicators for the forthcoming Ecuadorian economic groups. On a final note, and since the period of study employed for this research is from 2015–2019, future researchers can analyze the impact of the concentration of economic power in Ecuador, as well as the impact of the number of economic groups in other countries.

**Author Contributions:** All authors contributed extensively to the work presented in this paper. Writing—original draft preparation, A.B.T.-P.; writing—review and editing, M.E.M.-C. All authors have read and agreed to the published version of the manuscript.

**Funding:** We extend our gratitude and acknowledgment to the Universidad de las Américas, which financially supported this research (2021).

**Data Availability Statement:** The datasets used and analyzed in this study are available from the corresponding author on justified request.

**Conflicts of Interest:** The authors declare no conflict of interest. The funders had no role in the design of the study; in the collection, analyses, or interpretation of data; in the writing of the manuscript, or in the decision to publish the results.

## References

- Acosta, Alberto. 2006. *Breve Historia Económica del Ecuador*. Quito: Corporación Editora Nacional.
- Anaya, Eduardo. 1990. *Los Grupos de Poder Económico: Un Análisis de la Oligarquía Financiera*. Lima: Editorial Horizonte.
- Banco Central del Ecuador. 2021. Información Estadística Mensual. Available online: <https://contenido.bce.fin.ec/home1/estadisticas/bolmensual/IE Mensual.jsp> (accessed on 12 August 2021)
- Cañas, R. 2015. Caracterización de los grupos económicos en el Ecuador. *Investigación Económica* 8: 76–114.
- Centro de Estudios y Difusión Social (CEDIS). 1986. *Los Grupos Monopólicos en el Ecuador: Un Ensayo de Difusión Popular*. Accra: Centro de Estudios y Difusión Social (CEDIS). Portada.

- Chavarrín, Rubén. 2011. Los grupos económicos en México a partir de una tipología de arquitectura y gobierno corporativos, Una revisión de sus explicaciones teóricas. *El Trimestre Económico* 30: 193–234. [CrossRef]
- Constitución de la República del Ecuador. 2008. Available online: [https://www.oas.org/juridico/pdfs/mesicic4\\_ecu\\_const.pdf](https://www.oas.org/juridico/pdfs/mesicic4_ecu_const.pdf) (accessed on 12 August 2021).
- Cueva, Agustín. 1988. *El proceso de dominación política en el Ecuador*. Setagaya: Planeta.
- Dahse, Fernando. 1981. Mapa de la extrema riqueza. Los grupos económicos y el proceso de concentración de capitales. *NS, NorthSouth* 6: 99–103. [CrossRef]
- EKOS. 2012. Los colosos de la economía nacional. *EKOS Negocios* 215: 28–70.
- El Comercio. 2010. 28 Entidades que Quebraron por la Crisis de 1998 Fueron Cerradas. Available online: <https://www.elcomercio.com/actualidad/28-entidades-quebraron-crisis-1998.html> (accessed on 12 August 2021).
- Fierro, Luis. 1991. *Los Grupos Financieros en el Ecuador*. Bunkyo: Centro de Educación Popular, CEDEP.
- Fierro, Luis. 2019. Financial Groups in Ecuador—25 Years Later. *Revista PUCE* 108: 139–75.
- Frank, Robert H. 2005. *Microeconomía y Conducta*. Edited by Quinta Edi. New York: McGraw-Hill.
- Furió, Elies, and Matilde Alonso. 2008. Concentración económica: Algunas consideraciones sobre su naturaleza y medida. *Boletín económico de ICE, Información Comercial Española* 2947: 41–54.
- Garrido, Celso, and Wilson Peres. 1996. Grandes empresas y grupos industriales latinoamericanos. *Revista CEPAL* 66: 127–47. [CrossRef]
- Guriev, Sergei, and Andrei Rachinsky. 2005. The Role of Oligarchs in Russian Capitalism. *Journal of Economic Perspectives* 19: 131–50. [CrossRef]
- Iturralde, Pablo. 2017. Grupo Eljuri: Paraísos Fiscales y Corruptelas: Modelo Para (Des)armar. Available online: <https://lalineadefuego.info/grupo-eljuri-paraisos-fiscales-y-corruptelas-modelo-para-desarmar-por-pablo-iturralde-ruiz/> (accessed on 12 August 2021).
- Khanna, Tarun, and Yishay Yafeh. 2007. Business Groups in Emerging Markets: Paragons or Parasites? *Journal of Economic Literature* 45: 331–72. [CrossRef]
- Lagos, Ricardo. 1960. La Concentración del Poder Económico. Ph.D. Thesis, Universidad de Chile, Santiago, Chile.
- Lazzarini, Sergio G., Gary J. Miller, and Todd R. Zenger. 2008. Dealing with the Paradox of Embeddedness: The Role of Contracts and Trust in Facilitating Movement Out of Committed Relationships. *Organization Science* 5: 709–28. [CrossRef]
- Leff, Nathaniel H. 1978. Industrial Organization and Entrepreneurship in the Developing Countries: The Economic Groups. *Economic Development and Cultural Change* 26: 661–75. [CrossRef]
- Ley Orgánica de Regulación y Control del Poder de Mercado. 2011. . Available online: <https://www.planificacion.gob.ec/ley-organica-de-regulacion-y-control-del-poder-de-mercado/> (accessed on 12 August 2021).
- Llosas, Hernán. 2005. El Pensamiento Corporativo en Italia. Ph.D. Thesis, Universidad Nacional de La Plata, La Plata, Argentina.
- Manosalve, Martín. 2015. Reseñas—Schneider, Ben Ross. Hierarchical Capitalism in Latin America. Business, Labor and the Challenges of Equitable Development. *Economía-Reseñas* 38: 231–33.
- Marchán, Carlos. 2017. *Orígenes del Ecuador Republicano; Arquitectura Institucional Malograda del Estado Nacional*. Quito: Editorial IAEN.
- Minaya, Manuel. 2006. *Concentración Industrial en el Sector Comercio al por Menor del Ecuador: Un Análisis a Nivel de Subramas, Período 2000–2005*. Quito: Pontificia Universidad Católica del Ecuador.
- Misas, Gabriel. 1975. *Contribución al estudio del grado de concentración en la industria colombiana—Gabriel Misas Arango—Google Books*. Edited by Tiempo Presente. Santiago de Chile: Inst. Latinoamericano de Investigaciones Sociales (ILDIS).
- Navarro, Guillermo. 1975. *La Concentración de Capitales en el Ecuador*. Quito: Universidad Central del Ecuador—Escuela de Sociología Editorial Universitaria.
- Navarro, Guillermo. 2006. *Los Poderes Fáclicos Poder Económico, Poder político y Poder Factico*. Quito: Ediciones Zitra.
- Pástor, Carlos. 2015. Los Grupos Económicos en el Ecuador. pp. 1–82. Available online: <https://repositorio.uasb.edu.ec/handle/10644/5529> (accessed on 15 July 2021).
- Peralta, Pablo Ospina. 2015. Protesta social, crisis económica y escenario político Ecuador. In *Análisis de Coyuntura*. Quito: Centro Ecuménico de Proyectos.
- Revista Líderes. 2017. 215 Grupos Económicos Tiene el País; 25 se Sumaron en este año. Available online: <https://www.revistalideres.ec/lideres/informe-grupos-economicos-ecuador-sri.html> (accessed on 15 July 2021).
- Robinson, E.A.G. 1957. *La Dimensión óptima de la Empresa*. Buenos Aires: El Ateneo.
- Schneider, Ben Ross. 2013. *Hierarchical Capitalism: Business, Labor, and the Challenge of Equitable Development in Latin America*. Cambridge: Cambridge University Press.
- Servicio de Rentas Internas del Ecuador. 2015. *Reglamento Para la Aplicación de la Ley de Régimen Tributario Interno, LORTI*. Quito: Servicio de Rentas Internas del Ecuador.
- Servicio de Rentas Internas del Ecuador. 2020. *Catastro de Grupos Económicos 2020*. Quito: Servicio de Rentas Internas del Ecuador.
- Servicio de Rentas Internas del Ecuador. 2021. *Ranking of Ecuadorian Firms*. Quito: Servicio de Rentas Internas del Ecuador.
- Silva, Julio. 1977. Los Verdaderos dueños del país: Oligarquía y Monopolios en Colombia—Julio Silva Colmenares—Google Books. Fondo Editorial Suramérica. Available online: <https://www.worldcat.org/title/verdaderos-duenos-del-pais-oligarquia-y-monopolios-en-colombia/oclc/679746155> (accessed on 15 July 2021).

- Solano, Santiago, and Luis Tobar. 2017. Caracterización de los grupos económicos en Ecuador según el Servicio de Rentas Internas al año 2015. *Observatorio Economía Latinoamericana* 20. Available online: [https://www.researchgate.net/publication/333659229\\_CARACTERIZACION\\_DE\\_LOS\\_GRUPOS\\_ECONOMICOS\\_EN\\_ECUADOR\\_SEGUN\\_EL\\_SERVICIO\\_DE\\_RENTAS\\_INTERNAS\\_SRI\\_AL\\_ANO\\_2015](https://www.researchgate.net/publication/333659229_CARACTERIZACION_DE_LOS_GRUPOS_ECONOMICOS_EN_ECUADOR_SEGUN_EL_SERVICIO_DE_RENTAS_INTERNAS_SRI_AL_ANO_2015) (accessed on 15 July 2021).
- Strachan, Harry W. 1976. *Family and Other Business Groups in Economic Development: The Case of Nicaragua*. Westport: Praeger.
- Tobar, Luis, and Santiago Solano. 2017. La concentración financiero y los grupos de poder: Evidencias en la ciudad de Cuenca—Ecuador. *Revista Internacional Administración y Finanzas* 10: 81–90.
- Tulcanaza, Ana Belén. 2010. Concentración del Poder Económico en el Sector Comercio en Ecuador, período 2002–2008. Available online: <http://repositorio.puce.edu.ec/handle/22000/742> (accessed on 15 July 2021).
- Tulcanaza-Prieto, A. 2018. Grupos Económicos Ecuatorianos: Una Mirada hacia su Comportamiento 2015–2016. *Estado y Comunidades—Instituto de Altos Estudios Nacionales (IAEN)* 7: 181–200. [CrossRef]
- Tulcanaza-Prieto, A., and Younghwan Lee. 2018. Factors Associated with the Financial Performance of Commercial Firms in Ecuador. *Global Business Administration Review* 15: 1–26. [CrossRef]
- Tulcanaza-Prieto, Ana Belén, and Manuel Morocho-Cayamcela. 2018. Elasticity of the total production measured by the investment in information and communication technologies: Evidence from the ecuadorian manufacturing companies. *X-Pedientes Económicos* 2: 6–27.
- Tulcanaza-Prieto, Ana Belén, HoKyun Shin, Younghwan Lee, and Chang Won Lee. 2020. Relationship among CSR Initiatives and Financial and Non-Financial Corporate Performance in the Ecuadorian Banking Environment. *Sustainability* 12: 1621. [CrossRef]
- Unda, M., and E. Bethania. 2010. Burguesía ciudadana, nueva hegemonía, nueva alianza de clases. *Revista R* 69: 19–31. [CrossRef]
- Vanoni, Giuseppe, and Carlos Rodríguez. 2017. Estrategias de crecimiento implementadas por los grupos económicos del Ecuador (2007–2016). *Revista Innovar Journal* 27: 39–55. [CrossRef]
- Vito, Francesco. 1935. *L'essenza Dell'economia Corporativa*. Milano: Economía corporativa.
- Wilches, Giovanna, and Carlos Rodríguez. 2016. El proceso evolutivo de los conglomerados o grupos económicos en Colombia. *Innovar* 26: 11–34. [CrossRef]

## Article

# The Impact of COVID-19 on the US Economy: The Multiplier Effects of Tourism

Nikolaos Rodousakis<sup>1</sup> and George Soklis<sup>2,\*</sup><sup>1</sup> Centre of Planning and Economic Research (KEPE), 10672 Athens, Greece; nrodousakis@kepe.gr<sup>2</sup> Department of Public Administration, School of Economy and Public Administration, Panteion University, 17671 Athens, Greece

\* Correspondence: g.soklis@panteion.gr

**Abstract:** This article explores the multiplier effects on domestic product, employment, and the external sector of the US economy due to the decline of tourism activities during the pandemic. For this purpose, we use an input-output model and the latest available input-output data from the Organisation for Economic Co-operation and Development (OECD's) database. It was found that for every USD million decrease in tourism receipts, the net output decreases about USD 1.53 million, the level of employment decreases about 16.86 persons, imports decrease about USD 0.20 million, while the comparative analysis of these results with the economy's average multipliers indicates that tourism constitutes a key sector of the US economy. From the evaluation of the results, it is deduced that the decline of tourism activities recorded in the year 2020 accounts for about one-fourth of the observed recession in the US economy.

**Keywords:** coronavirus; US economy; multiplier effects; tourism sector

**Citation:** Rodousakis, Nikolaos, and George Soklis. 2022. The Impact of COVID-19 on the US Economy: The Multiplier Effects of Tourism. *Economies* 10, 2. <https://doi.org/10.3390/economies10010002>

Academic Editors: Ștefan Cristian Gherghina and Franklin G. Mixon

Received: 25 November 2021

Accepted: 17 December 2021

Published: 22 December 2021

**Publisher's Note:** MDPI stays neutral with regard to jurisdictional claims in published maps and institutional affiliations.



**Copyright:** © 2021 by the authors. Licensee MDPI, Basel, Switzerland. This article is an open access article distributed under the terms and conditions of the Creative Commons Attribution (CC BY) license (<https://creativecommons.org/licenses/by/4.0/>).

## 1. Introduction

The coronavirus shock to the growth dynamics of all the major economies in the world marked the year 2020. The economy of the United States (US), the largest economy in the world in terms of nominal gross domestic product (GDP), recorded a reduction in GDP of about 3.4% for the year 2020.<sup>1</sup> The recession of the US economy was close to the global average recession, but quite below the average recession amongst advanced economies (−4.7%), and the Euro area (−6.6%). These relatively good results for the US economy can be attributed to its structural characteristics.

Undoubtedly, tourism is one of the most vulnerable economic sectors in the pandemic. For example, according to World Tourism Organization (UNWTO), international tourism arrivals declined by 73% in the year 2020. Since tourism has become one of the major contributors to growth and employment worldwide in the last decades, it is important to study the effects on national economies caused by the decline of tourism activities during the pandemic. For example, the World Travel & Tourism Council (WTTTC 2021) estimates that before the pandemic, tourism accounted for 10.4% of global GDP and 10.6% of employment, while international travel expenditures accounted for 6.8% of world's total exports and 27.4% of services exports.

Recently, a number of research studies have focused on the impact on the economic systems related to the decline of tourism activities (see, e.g., Farzanegan et al. 2020; Lee and Chen 2020; Mariolis et al. 2020; Qiu et al. 2020; Rodousakis and Soklis 2021; Tsionas 2020; Yang et al. 2020). In this article we explore the multiplier effects on domestic product, employment, and the external sector of the US economy due to the decline of tourism activities during the pandemic. For this purpose, we use (a) an extension of Kurz's (1985) matrix multiplier framework; and (b) the latest available input-output data from OECD's (Organisation for Economic Co-operation and Development) database, <https://stats.oecd.org> (accessed on 30 September 2021).



The remainder is structured as follows. Section 2 presents the analytic framework. Section 3 presents the empirical results. Finally, Section 4 concludes.

**2. Methods and Materials**

To assess the multiplier effects of tourism on the US economy, we use a Sraffian multiplier framework inspired by the contribution of Kurz (1985) and the further generalisations provided by Metcalfe and Steedman (1981) and Mariolis (2008). More specifically, we consider an open economy with  $n$  products produced by  $n$  single-product activities, only circulating capital, fixed input-output coefficients, “stationary prices”, two types of income (i.e., wages and profits), no pass-through from tax rates to prices, and heterogeneous labour. By combining the price and quantity system of the above economy, we may derive the following equation<sup>2</sup>

$$y^T = \Pi d^T$$

where  $y^T$  denotes the net output vector with dimensions  $n \times 1$ ,  $d^T$  is the autonomous demand vector, which includes government consumption, investments and exports,  $\Pi \equiv [I - C + M]^{-1}$  represents the multipliers matrix of the economy, linking autonomous demand with net output,  $C \equiv [p - (s_w w \Lambda + s_p p H)] (pc^T)^{-1} c^T$  represents the consumption demand of the economy,  $c^T$  represents the consumption pattern (which is assumed to be uniform among wage and profit earners),  $s_w$  is the saving ratio associated with wage earners,  $s_p$  is the saving ratio associated with profit earners,  $\Lambda \equiv \hat{I}[I - A]^{-1}$  is the “vertically integrated labour coefficients” matrix,  $A (\geq 0)$  is the matrix of technical coefficients,  $H \equiv \hat{A}r[I - A]^{-1}$  is the “ $\hat{r}$ -vertically integrated technical coefficients matrix”,  $\hat{r}$  the diagonal matrix of sectoral profit rates,  $M \equiv \hat{m}[I - A]^{-1}$  represents the total import demand matrix, and finally,  $\hat{m}$  the diagonal matrix of imports per unit of output. On the basis of the above, we may easily derive the matrix of employment multipliers linking autonomous demand to the levels of sectoral employment from  $L^T = \Lambda \Pi d^T$ , where  $L^T$  gives the vector of employment per sector of the economy, and the matrix of import multiplier from  $im^T = \hat{m}[I - A]^{-1} \Pi d^T$ , where  $im^T$  denotes the import demand vector.

The necessary input-output data of the US economy for the empirical application of the multiplier analysis were retrieved from OECD’s database, <https://stats.oecd.org> (accessed on 30 September 2021). The OECD’s Input-Output Tables (IOTs) describe the production of 36 products by 36 corresponding sectors. The classification of the 36 sectors of the US economy is reported in Table 1 below.

**Table 1.** Sector classification.

No.	Nomenclature
1	Agriculture, forestry and fishing
2	Mining and extraction of energy producing products
3	Mining and quarrying of non-energy producing products
4	Mining support service activities
5	Food products, beverages and tobacco
6	Textiles, wearing apparel, leather and related products
7	Wood and products of wood and cork (except furniture)
8	Paper products and printing
9	Coke and refined petroleum products
10	Chemicals and pharmaceutical products
11	Rubber and plastics products

Table 1. Cont.

No.	Nomenclature
12	Other non-metallic mineral products
13	Manufacture of basic metals
14	Fabricated metal products, except machinery and equipment
15	Computer, electronic and optical products
16	Electrical equipment
17	Machinery and equipment NEC
18	Motor vehicles, trailers and semi-trailers
19	Other transport equipment
20	Other manufacturing; repair and installation of machinery and equipment
21	Electricity, gas, water supply, sewerage, waste and remediation services
22	Construction
23	Wholesale and retail trade; repair of motor vehicles
24	Transportation and storage
25	Accommodation and food services
26	Publishing, audiovisual and broadcasting activities
27	Telecommunications
28	IT and other information services
29	Financial and insurance activities
30	Real estate activities
31	Other business sector services
32	Public administration and defence; compulsory social security
33	Education
34	Human health and social work
35	Arts, entertainment, recreation and other service activities
36	Private households with employed persons

Now, to assess the multiplier effects of tourism receipts on the economic system we need to set the autonomous demand vector,  $\mathbf{d}$ , equal to the pattern of international travel receipts that corresponds to the 36 sectors classified in the IOTs of the US economy.<sup>3</sup> Moreover, we divide all the elements of  $\mathbf{d}$  by the total tourism receipts of the economy and, therefore, it holds  $\sum_{i=1}^{36} d_i = 1$ . The distribution of tourism receipts to the commodities of the different sectors of the US economy is represented in Figure 1: about 77.7% of the international travel receipts of the US economy are directed to the sectors “Accommodation and food services” (31.6%), “Transportation and storage” (14.3%), “Education” (13.8%), “Arts, entertainment, recreation and other service activities” (6.8%), “Wholesale and retail trade” (5.8%), and “Real estate activities” (5.4%), while about 22.3% of the travel receipts are directed to the rest of the 30 sectors.

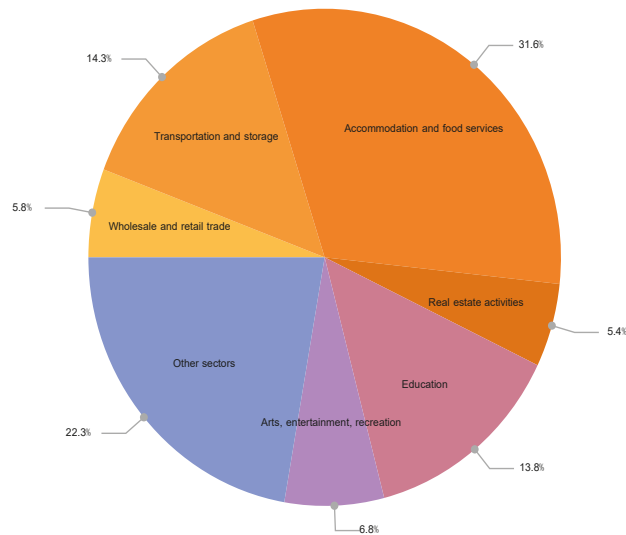


Figure 1. The distribution (%) of international travel receipts per sector, US 2015.

### 3. Empirical Results and Discussion

We apply the previous analysis to the IOTs of the US economy for the case where  $s_w = 0$  and  $s_p = 1$ . According to our estimates, each USD million decrease in tourism receipts caused a direct and indirect:

- Decrease in domestic product of about USD 1.53 million;
- Decrease in the level of employment of about 16.86 persons;
- Decrease in imports of about USD 0.20 million.

The decomposition of the multiplier effects on net output, employment, and imports, to each of the 36 sectors of the US economy is depicted in Figures 2–4, respectively.

From Figures 2 and 3, it follows that the output and employment multiplier effects in the US economy mainly affect the services, while, from Figure 4, it follows that the import multiplier effects are distributed to all the sectors of the US economy.

Now, to assess the relative significance of the tourism multiplier effects on the US economy, we compare the tourism multipliers with the average multipliers of the economy. Table 2 reports the average output, employment and import multipliers of the US economy. The third column of Table 2 reports the estimated tourism multipliers.<sup>5</sup>

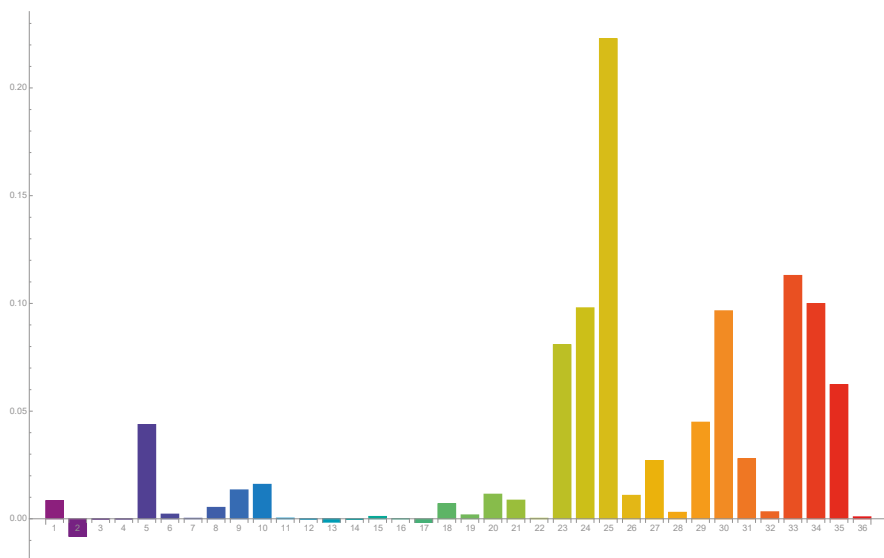
Table 2. Average versus tourism multipliers for the US economy, 2015.

Multipliers	Economy's Average	Tourism
Output	1.35	1.53
Employment	12.87	16.86
Imports	0.28	0.20

From the multipliers reported in Table 2, it follows that the US economy demonstrates relatively favorable tourism multipliers and, therefore, the tourism sector constitutes one of the key sectors of the US economy.

The US GDP reached USD 21,433,224.7 million, while the total level of employment was 157,538,100 persons.<sup>6</sup> Furthermore, UNWTO reports that the US's tourism receipts accounted for USD 193.3 billion in the year 2019, and USD 76.1 billion in the year 2020, recording a decline of about 61% in comparison to the previous year. Thus, from the previous analysis of the tourism multiplier effect on the US economy, it is deduced that the

decline of tourism receipts in the year 2020 is associated with a decrease in gross domestic output by 0.84%, a decrease in the employment level by 1.25%, and a decrease in the surplus of the balance of the external sector by USD 93.8 billion. It is interesting to note that if we make the extreme assumption that all tourism receipts of the US economy are lost (193.3 billion US dollars), then, according to our estimates, the gross domestic product would decrease by 1.38%, the employment level would decrease by 2.07%, and the surplus of the external sector would decrease by USD 154.6 billion. Now, if we take into account that the gross domestic product of the US economy declined by about 3.4% in the previous year, it then follows that the decrease of international travel receipts accounted for 24.7% of the actual recession in the US economy. Finally, to delve into the intersectoral dimensions of the multiplier effects of international travel receipts on the US economy, in Figure 5 we depict the decrease in domestic output per sector.



**Figure 2.** Sectoral decomposition of the tourism output multiplier, US 2015.

From Figure 5, it follows that 73.4% of the losses in domestic output of the US economy correspond to “Accommodation and food services” (22.3%), “Education” (11.3%), “Human health” (10.0%), “Transportation and storage” (9.8%), “Real estate services” (9.7%), “Wholesale and retail trade” (8.1%), and “Arts” (6.2%).

It is interesting to note that, using the same framework, [Rodousakis and Soklis \(2021\)](#) concluded that the decline in tourism receipts accounted for 11.8% of the actual recession in the German economy for the year 2020 and for 41.3% of the actual recession in the Spanish economy, while the sectoral decomposition of the output losses found in the current paper are more similar to those of the German than those of the Spanish economy. Thus, we may say that the relative impact of the decrease in tourism receipts in the US economy during the pandemic lies between those of the German and Spanish economies. These findings indicate that any travel restrictions imposed by the US authorities should carefully consider the economic impact of these restrictions. For example, before the pandemic, about one-fifth of the international visitors to the US came from Europe. Thus, the recent measures of the US government to lift travel restrictions from a number of countries while limiting the spread of COVID-19 will have a significant positive impact on the recovery of the economy.

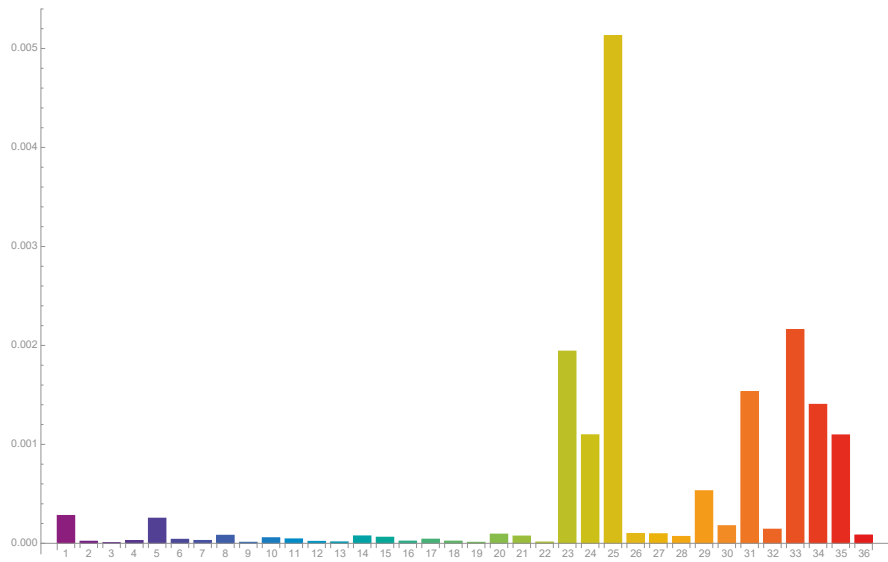


Figure 3. Sectoral decomposition of the tourism employment multiplier, US 2015.

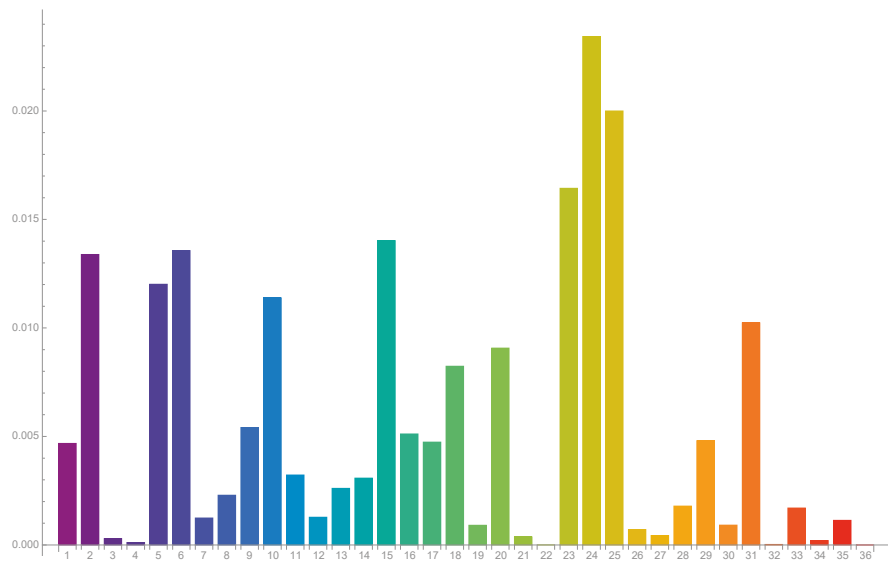


Figure 4. Sectoral decomposition of the tourism import multiplier, US 2015.

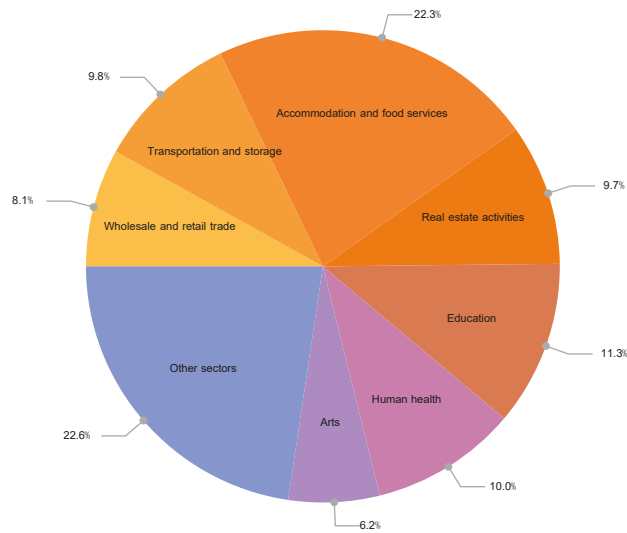


Figure 5. Sectoral decomposition (%) of the output losses in the US economy, 2015.

#### 4. Concluding Remarks

Using an input-output model and data from OECD's input-output database, this article explored the multiplier effects on domestic product, employment, and the external sector of the US economy due to the decline of tourism activities during the pandemic. It was estimated that each USD million decrease in tourism receipts caused a direct and indirect decrease in domestic product of about USD 1.53 million, a decrease in the level of employment of about 16.86 persons, and a decrease in imports of about USD 0.20 million. These multiplier effects indicate that the tourism sector constitutes one of the key sectors of the US economy, while its sectoral decomposition reveals that the most affected activities belong to service sector and, more specifically, to the sectors "Accommodation and food services", "Education", "Human health", "Transportation and storage", "Real estate services", "Wholesale and retail trade", and "Arts". Moreover, it was estimated that the decline in travel receipts accounts for about one-fourth of the actual recession in the US economy for the year 2020. Thus, even for a technological advanced economy such as that of the US, the significance of tourism activities for the economic system cannot be underestimated.

**Author Contributions:** The authors have equally contributed to all the stages of the research. All authors have read and agreed to the published version of the manuscript.

**Funding:** This research received no external funding.

**Institutional Review Board Statement:** Not applicable.

**Informed Consent Statement:** Not applicable.

**Data Availability Statement:** The input-output data used in the research were retrieved from OECD's database, <https://stats.oecd.org> (accessed on 30 September 2021).

**Acknowledgments:** We are indebted to four anonymous referees and the academic editor of this journal for helpful hints and comments. The usual disclaimer applies.

**Conflicts of Interest:** The authors declare no conflict of interest.

## Notes

- <sup>1</sup> After the longest recovery in its history, which started in June 2009, the US economy fell into recession in February 2020. For a detailed analysis of the developments of the US economy, see [Papadimitriou et al. \(2021\)](#).
- <sup>2</sup> For a detailed exposition, see, e.g., [Mariolis et al. \(2021\)](#); [Rodousakis and Soklis \(2021\)](#). For corresponding applications in a joint production framework, see [Mariolis and Soklis \(2018\)](#); [Mariolis et al. \(2018, 2020\)](#).
- <sup>3</sup> This data is given by “Direct purchases by non-residents (exports)”, which is included in the IOTs of the OECD’s database.
- <sup>4</sup> The analytical results are available on request from the authors. The variables necessary for the empirical analysis were constructed using information from IOTs and following the standard procedure in the relevant literature (see, e.g., [Mariolis et al. 2018](#), Appendix 1).
- <sup>5</sup> The average multipliers correspond to the changes on the money values of net output and imports, and on employment (measured in persons), respectively, induced by a simultaneous increase of  $\frac{1}{36}$  units in the autonomous demand for the product of each of the 36 sectors.
- <sup>6</sup> The data are obtained from <https://stats.oecd.org> (accessed on 30 September 2021).

## References

- Farzanegan, Mohammad Reza, Hassan F. Gholipour, Mehdi Feizi, Robin Nunkoo, and Amir Eslami Andargoli. 2020. International tourism and outbreak of coronavirus (COVID-19): A cross-country analysis. *Journal of Travel Research* 60: 687–92. [\[CrossRef\]](#)
- Kurz, Heinz Dieter. 1985. Effective demand in a “classical” model of value and distribution: The multiplier in a Sraffian framework. *Manchester School* 53: 121–37. [\[CrossRef\]](#)
- Lee, Chien-Chiang, and Mei-Ping Chen. 2020. The impact of COVID-19 on the travel and leisure industry returns: Some international evidence. *Tourism Economics*, in press. [\[CrossRef\]](#)
- Mariolis, Theodore. 2008. Pure joint production, income distribution, employment and the exchange rate. *Metroeconomica* 59: 656–65. [\[CrossRef\]](#)
- Mariolis, Theodore, and George Soklis. 2018. The static Sraffian multiplier for the Greek economy: Evidence from the supply and use table for the year 2010. *Review of Keynesian Economics* 6: 114–47. [\[CrossRef\]](#)
- Mariolis, Theodore, Nikolaos Ntemiroglou, and George Soklis. 2018. The static demand multipliers in a joint production framework: Comparative findings for the Greek, Spanish and Eurozone Economies. *Journal of Economic Structures* 7: 18. [\[CrossRef\]](#)
- Mariolis, Theodore, Nikolaos Rodousakis, and George Soklis. 2020. The COVID-19 multiplier effects of tourism on the Greek economy. *Tourism Economics* 27: 1848–55. [\[CrossRef\]](#)
- Mariolis, Theodore, Nikolaos Rodousakis, and George Soklis. 2021. Inter-sectoral analysis of the Greek economy and the COVID-19 multiplier effects. *European Politics and Society*, in press. [\[CrossRef\]](#)
- Metcalfe, Metcalfe, and Ian Steedman. 1981. Some long-run theory of employment, income distribution and the exchange rate. *Manchester School* 49: 1–20. [\[CrossRef\]](#)
- Papadimitriou, Dimtri, Michalis Nikiforos, and Gennaro Zezza. 2021. *The Pandemic, the Stimulus, and the Future Prospects for the US Economy. Strategic Analysis*. Annandaleon-Hudson: Levy Economics Institute of Bard College.
- Qiu, Richard T.R., Jinah Park, ShiNa Li, and Haiyan Song. 2020. Social costs of tourism amid COVID-19 pandemic. *Annals of Tourism Research* 84: 102994. [\[CrossRef\]](#) [\[PubMed\]](#)
- Rodousakis, Nikolaos, and George Soklis. 2021. The COVID-19 multiplier effects of tourism on the German and Spanish economies. *Evolutionary and Institutional Economics Review*, in press.
- Tsionas, Mike G. 2020. COVID-19 and gradual adjustment in the tourism, hospitality, and related industries. *Tourism Economics* 27: 1828–1832. [\[CrossRef\]](#)
- World Travel and Tourism Council (WTTTC). 2021. *Travel & Tourism: Economic Impact 2021*. London: WTTTC, April 6.
- Yang, Yang, Hongru Zhang, and Xiang Chen. 2020. Coronavirus pandemic and tourism: Dynamic stochastic general equilibrium modeling of infectious disease outbreak. *Annals of Tourism Research* 83: 102913. [\[CrossRef\]](#)

Article

# Stock Market Reactions during Different Phases of the COVID-19 Pandemic: Cases of Italy and Spain

Greta Keliuotyte-Staniuleniene \* and Julius Kviklis

Department of Finance, Faculty of Economics and Business Administration, Vilnius University, 10222 Vilnius, Lithuania; julius.kviklis@evaf.stud.vu.lt

\* Correspondence: greta.keliuotyte-staniuleniene@evaf.vu.lt

**Abstract:** The COVID-19 pandemic and pandemic-induced lockdowns and quarantine establishments have inevitably affected individuals, businesses, and governments. At the same time, the spread of the COVID-19 pandemic had a dramatic impact on financial markets all over the world and caused an increased level of uncertainty; the stock markets were no exception either. Most of the studies on the impact of the COVID-19 pandemic on stock markets are based either on the analysis of a relatively short period (the beginning of pandemic) or a longer period, which, in turn, is very heterogeneous in terms of both the information available on the COVID-19 virus and the measures taken to contain the virus and address the consequences of the pandemic. However, it is very important to assess the impact not only at the beginning of the pandemic but also in the subsequent periods and to compare the nature of this impact; the studies of this type are still fragmentary. Therefore, this research aims to investigate the impact of the COVID-19 pandemic on stock markets of two of the most severely affected European countries—Italy and Spain. To reach the aim of the research OLS regression models, heteroscedasticity-corrected models, GARCH (1,1) models, and VAR-based impulse response functions are employed. The results reveal that the stock market reaction to the spread of the COVID-19 pandemic differs depending on the country and period analyzed: OLS regression and heteroscedasticity-corrected models have not revealed the statistically significant impact of the spread of the COVID-19 pandemic, while impulse response functions demonstrated the non-zero primary response of analyzed markets to the COVID-19 shock, and GARCH models (in the case of Spain) confirmed that the COVID-19 pandemic increased the volatility of stock market return. This research contributes to the literature by providing a comprehensive impact assessment both during the whole pre-vaccination period of the pandemic and during different stages of this period.

**Citation:** Keliuotyte-Staniuleniene, Greta, and Julius Kviklis. 2022. Stock Market Reactions during Different Phases of the COVID-19 Pandemic: Cases of Italy and Spain. *Economics* 10: 3. <https://doi.org/10.3390/economics10010003>

Academic Editors: Ștefan Cristian Gherghina, Ralf Fendel and Robert Czudaj

Received: 17 September 2021

Accepted: 13 December 2021

Published: 22 December 2021

**Publisher's Note:** MDPI stays neutral with regard to jurisdictional claims in published maps and institutional affiliations.



**Copyright:** © 2021 by the authors. Licensee MDPI, Basel, Switzerland. This article is an open access article distributed under the terms and conditions of the Creative Commons Attribution (CC BY) license (<https://creativecommons.org/licenses/by/4.0/>).

**Keywords:** COVID-19 pandemic; stock market; stock index; market volatility; impulse response functions; GARCH (1,1) model

## 1. Introduction

On 11 March 2020, the World Health Organization officially declared the coronavirus (COVID-19) outbreak to be a global pandemic. In more than a few months the COVID-19 pandemic spreaded across the world, paralyzing daily economic and social life. While the numbers of affected individuals are increasing and the global economic impacts are unclear, the financial markets are no exception either. During the year 2020, many countries recorded a drop in the stock exchange indexes. Some of the countries, such as the USA, recorded the highest plunge in the stock index in the 21st century, whereas countries such as New Zealand did not experience such a decrease. According to Shehzad et al. (2020), the USA and Europe financial markets were more affected by the COVID-19 pandemic compared to Asian financial markets; moreover, Asian financial markets provide greater opportunities to diversify financial risks.

Most of the studies on the impact of the COVID-19 pandemic on stock markets are based either on the analysis of a relatively short period (the beginning or the “first wave” of the pandemic) or a longer period, which, in turn, is very heterogeneous in terms of both the



information available on the COVID-19 virus and the measures taken to contain the virus and address the consequences of the pandemic. However, it is very important to assess the impact not only at the beginning of the pandemic but also in the subsequent periods and to compare the nature of this impact; the studies of this type are still fragmentary. Therefore, this paper aims to investigate the impact of the COVID-19 pandemic on the stock exchange indexes in Italy and Spain during the period of 1 March 2020 to 30 November 2020, dividing it into three phases of different characteristics.

The selection of these countries for the research is based on the fact that both countries had tremendous financial and economic consequences regarding the virus pandemic. Experiencing the disclosure of the financial markets led to a significant drop in share prices; therefore, in response to such events, the Italian FTSE MIB 40 and Spanish IBEX 35 stock indexes decreased as well. The selection of two individual countries instead of a wider sample is based on the need to analyze the response of individual stock markets instead of accumulated global or regional response since the response of the countries in the sample may be of the opposite nature. For example, [Cheong et al. \(2020\)](#) analyzed if the financial markets overreacted to the COVID-19 pandemic from December 2019 to January 2020 and February 2020 to March 2020. According to the provided descriptive statistics, many selected sample countries' financial markets reacted to COVID-19 spread during the first period, except Malaysia and Thailand. Yet, during the February to March 2020 period, all countries had a lower negative mean of returns. The MSCI World Index recorded highs that were higher than the first pandemic period in Australia, Singapore, Thailand, and the United States of America.

Thus, as is stated by [Cheong et al. \(2020\)](#): (i) every country has different effects from the pandemic, and it is important to understand that such a phenomenon cannot be studied in a generalized way; and (ii) the global or regional samples will not provide correct conclusions—instead, the focus should be pointed to individual countries and their macro- and micro-level reactions to the COVID-19 pandemic.

Unlike other studies, this research aims to investigate the impact of COVID-19 on Italy (FTSE MIB 40) and Spain (IBEX 35) stock exchange indexes during the three separate periods: period 1—1 March to 31 May 2020; period 2—1 June to 31 August 2020; period 3—1 September to 30 November 2020, covering two waves of pandemic and the recovery period between them. These periods at least partially coincide with the first wave of the pandemic, the so-called quiet period, and the second wave of the pandemic. This allows us not only to evaluate the impact of the COVID-19 pandemic on stock markets quantitatively but also to compare this impact during the different periods or the phases of the pandemic, at the same time perceiving critical and stabilization periods. On the one hand, as is stated by [Ciner \(2021\)](#), stabilization of the stock markets is crucial to seeking economic recovery in the face of the COVID-19 pandemic and after it; on the other hand, it is very important to learn the lesson from such a rare pandemic, because there is a possibility that mankind will encounter similar “unusual disasters” in the future. It is the analysis of the effect of the COVID-19 pandemic on stock markets that provides a unique opportunity to identify the patterns for future preparations.

The number of confirmed cases of COVID-19 infection is selected as an independent variable, the FTSE MIB 40 and IBEX 35 indexes are selected as dependent variables, and the CBOE Volatility Index is selected as a control variable for our research. To reach the aim of this study, and based on previous studies, the research of three stages is conducted employing the following methods: (i) simple OLS (bivariate) regression, the ARCH-LM test, and robust Heteroskedasticity and Autocorrelation Consistent Covariance Method (HAC); (ii) VAR-based impulse response functions; (iii) GARCH (1,1) model; the average and percentage changes of index values and their volatility (measured as standard deviation) are also analyzed to confirm the results of regression analysis.

The most important contribution of this research to the existing literature is that even if the impact of the COVID-19 pandemic on financial markets has been widely analyzed recently, the analysis of separate stages of the pandemic is not still widely developed.

Thus, this research provides a comprehensive impact assessment both during the whole pre-vaccination period of the pandemic and during different stages of this period.

The rest of this paper is structured as follows: (i) in Section 2, the main findings of the analysis of academic literature in the field of the COVID-19 impact on stock markets are discussed; (ii) in Section 3, the assumptions and design of the research are described; (iii) in Section 4, the results of the assessment of the impact of the COVID-19 pandemic on stock markets are discussed and compared; and, finally, (iv) the conclusions, limitations, and directions for future research are presented.

## 2. Literature Review

As well as other financial markets, the stock markets have been inevitably affected by the COVID-19 pandemic—uncertainty in the financial world increased, expectations of market participants deteriorated. The primary negative shock was sudden and severe, in some respects even compared to the Great Financial Crisis of the year 2007–2008. On 12 March 2020, it was stated that “It was a historic day on Wall Street. The Dow plunged 10% for its worst day since Black Monday in 1987. The 30-stock index fell 2352 points—its largest point drop on record. Meanwhile, the S&P 500 plunged 9% to close in the bear market territory, thus officially ending the bull market that began in 2009 during the throes of the financial crisis” (Stevens et al. 2020). A couple of days later, S&P Global reported that “It’s now clear that the hit to global economic activity from the measures to slow the spread of the coronavirus pandemic will be massive” (S&P Global Report 2020).

A significant number of researchers (for example, Sansa 2020; Ciner 2021; Ftiti et al. 2021; O’Donnell et al. 2021; Wei and Han 2021; Cheong et al. 2020; Izzeldin et al. 2021; Ashraf 2020; Dias et al. 2020; Wang and Enilov 2020; Zhang et al. 2020; Gormsen and Koijen 2020; Kanapickiene et al. 2020; He et al. 2020; Schoenfeld 2020; and others) have analyzed the impact of the COVID-19 pandemic on global or regional financial markets. Analysis of the results of these studies discloses clear evidence that the sudden spread of the COVID-19 pandemic had a major impact on the financial markets all around the world.

For example, Ben Haddad et al. (2021) have analyzed the volatility in commodity markets and found out that the COVID-19-pandemic-induced crisis has caused one of the highest volatility periods from the 1960s. Rakha et al. (2021) employed artificial intelligence and data from previous crises to assess and predict the economic impact of the COVID-19 pandemic in the United Kingdom; predictions showed a steady growth of GDP in 2021, although at around −8.5% contraction in comparison with pre-pandemic forecasts.

Sansa (2020) investigated if there was an impact of the COVID-19 on the financial markets in the USA within the period of 1 March 2020 to 25 March 2020. The research results revealed a positive relationship between the COVID-19 confirmed cases and New York Dow Jones Financial Stock. The research of Yousaf et al. (2020) revealed the increased volatility of stock market return in Russia, India, Brazil, and Peru.

Ashraf (2020) researched proof that stock markets react to new COVID-19 cases, but not the fatalities. According to panel pooled ordinary least squares regression results, the increase in confirmed cases variable is negative and more significant, in comparison with the growth in the deaths variable, and it loses significance when daily fixed-effects dummy variables are added into the model. Thus, the author confirms that daily growth in COVID-19 confirmed cases has a strong negative correlation with stock market returns in 64 selected sample countries. However, the growth in the deaths variable also has a negative result, yet the stock market response to the number of deaths is relatively low. Findings suggest that stock market prices react strongly during the early days of confirmed cases and less when confirmed cases die later on. O’Donnell et al. (2021) also examined the responses of China, Italy, Spain, the UK and the USA equity indexes to the growth of COVID-19 confirmed cases and confirmed that the equity index faced a significant negative shock due to the increasing number of COVID-19 confirmed cases. Analyzing the sample of the top 10 countries, Zhang et al. (2020) also revealed that the growth of confirmed cases is related to the increase in risk levels; the important role of market sentiment is highlighted.

Czech et al. (2020) analyzed the COVID-19 impact on the financial markets of Visegrad Group countries and used the TGARCH model to measure the impact of COVID-19 cases on the exchange rates and stock market volatility. The results revealed that the COVID-19 pandemic had a negative impact on the Visegrad financial markets and that during the pandemic the volatility increased (Czech et al. 2020).

Ramelli and Wagner (2020) analyzed how international companies reacted in the first months of the COVID-19 pandemic outburst. Researchers selected to investigate three periods from the beginning of January to the end of March 2020. The results provided information that the COVID-19 pandemic issue topic accrued more often on calls in companies that have a stronger connection with international trade and also companies that have higher liquidity risks. The approach of selecting the different periods provided results with concerns that varied from period to period. For example, the international trade concern was mostly discussed during the outbreak period, while the liquidity topic was discussed in the fever (last) period. Thus, the financial state and international trade concerns in the companies were discussed in different periods and concluded that such factors had an important effect on stock market reactions.

Ibrahim et al. (2020) analyzed the relationship between the COVID-19 pandemic in its first wave, response measures implemented by governments, and stock market volatility in Asia-Pacific countries. The results indicated increased levels of volatility in the face of pandemic and stabilizing effects of government measures.

Ftiti et al. (2021) revealed that the COVID-19 crisis negatively affected the Shanghai stock market—price volatility increased and the level of liquidity decreased. According to the researchers, the knock-on effect was caused by an unprepared healthcare system, when the crisis-induced supply shock directly harmed the financial market. Izzeldin et al. (2021) used the most recent data available from G7 countries' (USA, UK, France, Japan, Germany, Italy, and Canada) stock markets and categorized volatility analysis in 10 business sectors. The findings of this research revealed that: (i) the sectors of health care and consumer services were the most severely affected by the COVID-19 pandemic, (ii) while the sectors of telecommunications and technology were affected the least severely; (iii) United Kingdom and United States of America financial markets were affected the most, yet with big response heterogeneity across the business sectors.

Dias et al. (2020) have also analyzed G7 countries and revealed that during the period from 31 December 2019 to 23 July 2020, most markets displayed structure breaks between February and March 2020, because of global pandemic disruption. Furthermore, the findings of Wang and Enilov (2020) suggest that COVID-19 was able to establish a dominant short-term influence on the stock movement in financial markets, and it appears that it has the most significant effect on the largest advanced economies in the world.

The COVID-19 pandemic appeared to have a stronger effect on American and European stock markets compared to Asian stock markets. Despite the fact that in February 2020 China's markets demonstrated a high level of uncertainty (measured by standard deviation), it decreased substantially in March 2020. At the same time, the US market volatility (measured by standard deviation) in March 2020 appeared to be nearly four times higher than in February 2020 (Zhang et al. 2020). Consumer spending in the Euro Area decreased from EUR 1532.09 billion to EUR 1463.141 billion in the first quarter of 2020 (Eurostat Database). Furthermore, after most of the Eurozone countries imposed strict quarantine and citizens were isolated in their houses, consumer spending decreased to EUR 1282.21 billion in the second quarter of 2020. In addition, the Eurozone economy's gross domestic product shrank by 11.8% in the second quarter, whereas in the second quarter of 2019 it was increasing by 0.1% (Trading Economics 2020). Nevertheless, in the third quarter of 2020 "The Eurozone economy grew by 12.6 percent in the three months to September 2020, recovering from a record slump of 11.8 percent in the previous period and compared with early estimates of a 12.7 percent advance. It was the steepest pace of expansion since 1995" (Trading Economics 2020). These unprecedented circumstances led to the growth of scientific studies (for example, Frezza et al. 2020; Klose and Tillmann 2021; Bonaccolto

et al. 2019; Nieto and Rubio 2020; Ahmar and del Val 2020; and others) concentrating on European stock markets and their reaction to the spread of the COVID-19 pandemic.

Using the multifractional Brownian motion as a model of the price dynamics, Frezza et al. (2020) analyzed the influence of the COVID-19 pandemic on the efficiency of 15 European financial markets; the pattern before and after the two pandemic crashes was estimated; the results revealed that European markets' recovery of efficiency lasted not for long and, in accordance with the model, the volatility is still too high to be compatible with market efficiency. Bonaccolto et al. (2019) provided some evidence of an increase in the conversion risk for France and Italy since the beginning of January 2020. According to Nieto and Rubio (2020), analysis of the Spanish stock market revealed that, due to the COVID-19 pandemic, IBEX 35 stock index decreased significantly, and volatility increased to levels similar to the Great Recession (Nieto and Rubio 2020). Thus, rising uncertainty worldwide and an increase in risk aversion formed the behavior of financial markets during the first two quarters of the year 2020. Nevertheless, Ahmar and del Val (2020) determined that the Spanish stock market began to stabilize on the 24 March 2020.

A number of studies (for example, Fassas 2020; Kanapickiene et al. 2020; Albuлесcu 2020; Huynh et al. 2021; Panyagometh 2020) analyze the impact of the spread of the COVID-19 pandemic on the sentiment of financial market participants as well as on a broad economic sentiment. For example, Kanapickiene et al. (2020) analyzed the relationship between pandemic and economic sentiment and determined that customer sentiment was not so volatile as business sentiment. The results of Albuлесcu's (2020) study demonstrated that VIX, the so-called "fear factor", showing overall uncertainty in financial markets, significantly increased at the beginning of the COVID-19 pandemic. Huynh et al. (2021) analyzed investor sentiment in the face of the COVID-19 pandemic and pointed out that such countries as the United Kingdom, China, the United States, and Germany experienced sentimental shocks; moreover, these shocks were transmitted to other markets. Those shocks were also confirmed by the study conducted by Panyagometh (2020), which also indicated a negative reaction of Thailand's stock market. Fassas (2020) analyzed connectedness across the variance risk premium in both developed and emerging equity markets and revealed that, due to the COVID-19 pandemic, the interconnectedness of investor sentiment, as well as the degree of risk aversion, increased.

Finally, it is important to mention that the impact of the COVID-19 pandemic on financial markets has led to changes in the efficiency of standard economic policy measures. For example, using the method of panel analysis for European countries, Klose and Tillmann (2021) determined that: (i) announcements of policy initiatives and regulation adjustments positively assisted some countries and led to a slight increase in stock prices; (ii) the increasing number of COVID-19 cases raised bond yields, showing deteriorating investor expectations; (iii) announcements of national liquidity assistance programs and national fiscal policy add input in rising the bond yields; (iv) purchase programs of the central bank led to raised stock prices and reduced bond yields; and (v) countries which are affected by increasing the growth of COVID-19 cases could face an increase in bond yields on days of a fiscal policy announcement, whereas the same announcement in less affected countries keeps yields unchanged. Wei and Han (2021), using the sample of 37 severely affected countries, estimated the impact on the transmission of monetary policy to financial markets in the face of the COVID-19 pandemic and revealed that, during the 2020 COVID-19 pandemic period, both conventional and unconventional monetary policy had significant effects on the financial markets, including exchange rate, governmental bond, CDS markets, and stocks. However, unconventional monetary policies were more effective, rather than conventional policies, since they can affect the stock, exchange rate, and markets to some degree.

Further, the design of our research is discussed.

### 3. Research Methodology

#### 3.1. Data Selection

As mentioned in previous sections, seeking to achieve the main purpose of this research, i.e., to assess the impact of the COVID-19 pandemic on the European stock markets, the stock markets of Italy and Spain are selected for further research.

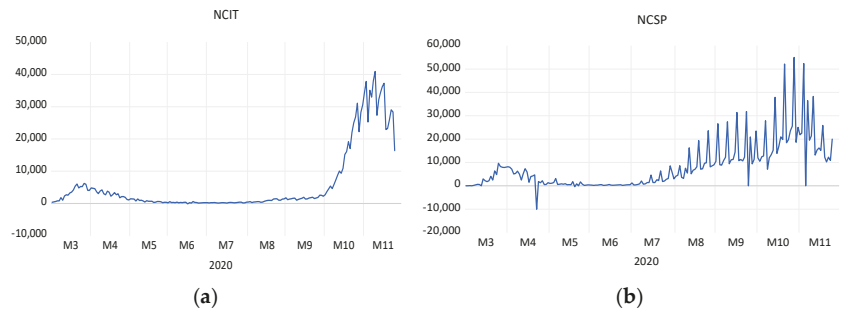
As is stated by [Borri \(2020\)](#), Italy is assumed to be one of the first European economies struck by the COVID-19 pandemic, as well as one of the most severely affected. Health crisis, the strict lock-down, and unsuspected virus spread for 4 months led to economic and financial problems. Equity markets dropped, first, by roughly 35% in Italy and the rest of the Eurozone; interventions of the central banks at least partially helped to limit uncertainty in financial markets; however, while the United States stock markets regained their potential almost fully later in 2020, the Eurozone and specifically Italy's market remained about 15% lower than at the beginning of 2020 ([Borri 2020](#)).

[Henriquez et al. \(2020\)](#) noted that the Spanish stock market was also significantly hit by the COVID-19 pandemic: a significant decrease in the IBEX 35 stock index has been recorded since January 2020. However, in mid-June 2020, a significant increase appeared due to the credit loans for the tourism sector, which played an important role in Spain's economy ([Instituto Nacional de Estadística 2020](#)).

As mentioned in the introductory section, unlike previous studies, this research aims to evaluate the impact of the COVID-19 pandemic on Italy (FTSE MIB 40) and Spain (IBEX 35) stock exchange indexes during the two waves of pandemic and the recovery period between them (see [Figure 1a,b](#)). The first period is dated from 1 March 2020 to 31 May 2020, and is selected to represent the beginning or so-called first wave of the spread of the COVID-19 pandemic: from the beginning of March 2020, active cases of COVID-19 started rapidly rising in Italy and Spain, whereas at the end of May it stabilized to numbers similar to those seen at the beginning of March; thus, according to researchers, it was cited as the first wave of the COVID-19 pandemic. The second period is dated from 1 June 2020 to 31 August 2020, and is selected to represent the so-called quiet period after the beginning of the first wave of a pandemic: during the summer of 2020, both Italy and Spain had a stable and controlled situation without any drastic fluctuations in active cases of COVID-19; therefore, this period was established as a recovery period. Finally, the third period is dated from 1 September 2020 to 30 November 2020, and is selected to represent the second wave of the spread of the COVID-19 pandemic: during this period, the new confirmed cases of COVID-19 raised to new records in both countries, leading people to believe that the second pandemic wave was defined. After the summer 2020 season, both The Ministry of Health in Spain and The Ministry of Health in Italy ([Sen 2020](#)) governmental entities released public statements that one way or another the second wave of the COVID-19 pandemic would take place in the upcoming autumn months. Therefore, Period 3 is analyzed to reveal market reaction during the beginning and middle stages of the second wave of the COVID-19 pandemic. Unlike the research of [Ramelli and Wagner \(2020\)](#) (see [Section 2](#)), our research covers longer data series and allows for employing different methods of analysis.

The spread of the COVID-19 pandemic had a tremendous impact on both Italy and Spain during the 1st period (1 March to 31 May 2020): on the one hand, Italy's financial and health sectors were unprepared for such disaster; on the other hand, the uncontrolled spread of the COVID-19 virus in Spain began later on. That being the case, it is very interesting to analyze and compare how Italian and Spanish stock exchange indexes reacted to the pandemic.

Further, the methods used to analyze this reaction are discussed.



**Figure 1.** Number of daily confirmed COVID-19 cases in Italy (Panel a) and Spain (Panel b) in 2020. Source: compiled by the authors on the basis of Our World in Data Coronavirus Pandemic (COVID-19) database. Note: M3 = March; M4 = April; M5 = May; M6 = June; M7 = July; M8 = August; M9 = September; M10 = October; M11 = November; for variable abbreviations, see Table 1.

### 3.2. Research Design

As was mentioned in the previous section, numerous studies analyze the impact of the COVID-19 pandemic on different national or regional stock markets, as well as on the global stock market. Analysis of the methods used in these studies (for example, Zhang et al. 2020; Sansa 2020; Ashraf 2020; Wang and Enilov 2020; Chikri Hassan et al. 2020; Klose and Tillmann 2021; Ciner 2021; Dias et al. 2020; Ahmar and del Val 2020; Kanapickiene et al. 2020; Lee 2020; and others) revealed that: (i) simple linear regression models estimating the relationship between independent and dependent variables are one of the most popular methods to assess the impact of the COVID-19 pandemic (Zhang et al. 2020; Sansa 2020; Ashraf 2020; Lee 2020); (ii) panel models are also used for these estimations (Wang and Enilov 2020; Klose and Tillmann 2021); (iii) vector autoregression (VAR) models and VAR-based impulse response functions are employed to investigate the response of financial markets to the spread of the pandemic (Shahzad et al. 2021; Ahundjanov et al. 2020; Beirne et al. 2020; Brueckner and Vespignani 2020; Milani 2021; Thakur 2020; Xu 2021); (iv) GARCH models are widely applied to assess the stock market (return) volatility in the face of the pandemic (Gherghina et al. 2021; Chaudhary et al. 2020; Duttalo et al. 2021; Endri et al. 2020); (v) and, finally, other regression techniques (such as NARDL, Detrended Fluctuation Analysis and Detrended Cross-Correlation Analysis, Lasso penalized regression, Arima and SutteArima) are also popular (Chikri Hassan et al. 2020; Dias et al. 2020; Ciner 2021; Ahmar and del Val 2020).

Our research itself consists of three main stages, which are further discussed briefly.

In Stage 1, the regression model is employed to investigate the possible effect of the spread of the COVID-19 pandemic on the Italian and Spanish stock markets. Thus, as is done in similar studies in the field (for example, Albulescu 2020; Zhang et al. 2020; Klose and Tillmann 2021; Sansa 2020; Kanapickiene et al. 2020; Ashraf 2020; and others), in our research, the method of simple OLS (bivariate) regression is chosen as it can efficiently examine the relationship between stock indices and COVID-19 confirmed cases. Simple OLS (bivariate) regression models are created for each period and each country.

It is important to mention that different studies use different COVID-19-related variables, for example, the number of affected countries (Albulescu 2020), the cumulative number of total cases of COVID-19 infection (Ashraf 2020; Al-Awadhi et al. 2020; Zhang et al. 2020; Czech et al. 2020) and the daily number of cases of COVID-19 infection (Albulescu 2020; Zaremba et al. 2020). Following the recent studies, we select the number of newly confirmed cases of COVID-19 infection and the growth rate of this number as an independent variable because we aim to assess how markets respond to the changing situation daily.

As dependent variables, two indexes: the FTSE MIB 40 index (Milano Indice di Borsa) representing the Italian stock market and the IBEX 35 index (Índice Bursátil Español)

representing the Spanish stock market, were selected. Natural logarithms of indexes are used for further analysis.

The FTSE MIB 40 (Milano Indice di Borsa) was selected because it is the national Italian stock exchange index, which consists of the 40 top traded stock classes. Moreover, it is a volatile index that frequently sees large moves and double-digit annual changes. According to [AvaTrade \(2021\)](#), FTSE MIB 40 includes powerful multi-national companies such as ENI Group, STMicroelectronics, and Fiat Chrysler, along with domestic Italian companies. Thus, the index can be used as an estimate of the overall Italian economy. IBEX 35 (Índice Bursátil Español) was chosen as it represents 35 of the largest Spanish companies, such as Repsol (oil/gas), Santander (finance/banking), and others ([AvaTrade 2021](#)). Thus, the IBEX 35 index can be seen as one of the indicators of the overall view of the Spanish stock market condition. For GARCH model indexes (see Section 4.3), we use the daily return of selected.

Seeking to assess the robustness of the relationship analyzed, the control variable is also included in the specifications of our models. In this research, the CBOE Volatility Index (VIX) was used as a financial benchmark tracking stock market volatility (on the basis of S&P500 Index option prices). This index was chosen as it measures the expected volatility (market expectations) of the U.S. equity market. According to [Moran and Liu \(2020\)](#), VIX is usually negatively correlated with price movements of the stock indexes, and, in periods of sharp decline in stock markets, it tends to rise. [Grima et al. \(2021\)](#) used the VIX index to assess the effect of daily new cases and deaths caused by COVID-19 on major stock markets, and [Shankar and Dubey \(2021\)](#) included VIX as a control variable in the model assessing the impact of the COVID-19 pandemic on the Indian stock market. [Baek et al. \(2020\)](#) also included VIX as a regressor in models measuring the impact of COVID-19 related news on US stock market volatility.

Seeking to check the stationarity of selected variables and their suitability for regression models, before constructing regression models, the unit-root test is conducted and the results of the Augmented Dickey–Fuller test (ADF) are evaluated (data are differenced if necessary) (the ADF test was conducted using a constant, lag length selected using the Schwarz information criterion, max lags = 14). After constructing OLS regression models, they are checked for the heteroscedasticity and residuals—the ARCH effect is tested using the ARCH-LM test (lag length  $q = 1$ ). In the presence of the ARCH effect, the robust Heteroskedasticity and Autocorrelation Consistent Covariance Method (HAC) is employed and heteroscedasticity-corrected models are created.

In Stage 2, we employ impulse response functions to identify and assess the response of selected index values to the spread of the COVID-19 pandemic. As is done in the studies of [Mzoughi et al. \(2020\)](#) and [Brueckner and Vespignani \(2020\)](#), we use VAR-based impulse response functions. After all variables are checked for stationarity in Stage 1 (Augmented Dickey–Fuller test), VAR models are constructed when it is meaningful. Lag selection in VAR models is made using Aikake, Schwarz, and Hannan–Quinn information criteria. Finally, using previously described COVID-19-related (as an impulse) and stock-market-related (as a response) variables, we construct impulse response and accumulated impulse response functions.

Finally, in Stage 3, taking into account that the HAC method may not fully correct the influence problems induced by the ARCH effect, we have additionally decided to estimate the GARCH model to assess the impact of the COVID-19 pandemic on the volatility of Italian and Spanish stock markets. We apply the generalized autoregressive conditional heteroscedasticity (GARCH) approach as it is in previous studies ([Gherghina et al. 2021](#); [Chaudhary et al. 2020](#); [Dutillo et al. 2021](#); [Endri et al. 2020](#)). It should be noted that the GARCH model is constructed only in the case of the presence of the ARCH effect (after the ARCH-LM test). We employ the GARCH (1,1) model as a standard and most widely used GARCH-type model. At first, we calculate the daily returns of FTSE MIB 40, and IBEX 35 indexes are calculated using the following formula (natural logarithm difference approach) ([Chaudhary et al. 2020](#)):

$$R_{i,t} = \ln \left( \frac{P_{i,t}}{P_{i,t-1}} \right) \quad (1)$$

where:  $R_{i,t}$  corresponds to the daily return on index  $i$  at time  $t$ ;  $P_{i,t}$  corresponds to the daily closing price of index  $i$  at time  $t$ ; and  $P_{i,t-1}$  corresponds to the daily closing price of index  $i$  at time  $t - 1$ .

In case the data series demonstrates heteroscedasticity, they are modeled using the GARCH (1,1) model. In line with Chaudhary et al. (2020) and taking into account that we use the COVID-19-related variable (number of daily new cases of infection) as an exogenous variable in the GARCH model, our model can be described as follows:

Conditional Mean Equation

$$y_t = \mu + \lambda_1 \text{COVID}_t + \lambda_2 \text{VIX}_t + \varepsilon_t \quad (2)$$

Conditional Variance Equation

$$h_t^2 = \omega + \alpha_1 \varepsilon_{t-1}^2 + \beta_1 h_{t-1}^2 \quad (3)$$

where:  $y_t$  corresponds to the conditional mean;  $h_t$  corresponds to the conditional variance;  $\mu$  and  $\omega$ —constant terms;  $\varepsilon_t$ —error term of the mean equation;  $\alpha_1$  and  $\beta_1$ —coefficients of the ARCH and GARCH terms.

Moreover, seeking to complement the results of analysis, the average and percentage changes of index values and their volatility (measured as the average of the monthly standard deviation of index return) are calculated for each country and each of the three periods. Daily data are used. The increase in the standard deviation allows for assuming the increase in volatility in the stock market.

The data of daily COVID-19 cases in Italy and Spain are retrieved from the Our World in Data Coronavirus Pandemic (COVID-19) database, and the data of selected stock indexes are retrieved from the Bloomberg database (research variables are summarized in Table 1). Collected data are organized and analyzed using the quantitative method technique and application of Eviews11 software package.

**Table 1.** Research variables and abbreviations.

Variable		
Abbreviation	Full Name	Source
Dependent variables		
lnFTSEMIB40 <sub>t</sub>	Natural logarithm of Milano Indice di Borsa—Italian stock market index value	Bloomberg database
lnIBEX35 <sub>t</sub>	Natural logarithm of Índice Bursátil Español—Spanish stock market index value	Bloomberg database
Ret.FTSEMIB40 <sub>t</sub>	Daily return of Milano Indice di Borsa—Italian stock market index	Bloomberg database
Ret.IBEX35 <sub>t</sub>	Daily return of Índice Bursátil Español—Spanish stock market index	Bloomberg database
Independent variables		
grNCIT <sub>t</sub>	Growth of the number of new daily confirmed cases of COVID-19 infection in Italy	Our World in Data Coronavirus Pandemic (COVID-19) database
grNCSP <sub>t</sub>	Growth of the number of new daily confirmed cases of COVID-19 infection in Spain	Our World in Data Coronavirus Pandemic (COVID-19) database
NCIT <sub>t</sub>	New daily confirmed cases of COVID-19 infection in Italy	Our World in Data Coronavirus Pandemic (COVID-19) database
NCSP <sub>t</sub>	New daily confirmed cases of COVID-19 infection in Spain	Our World in Data Coronavirus Pandemic (COVID-19) database
Control variable		
VIX <sub>t</sub>	CBOE Volatility Index	Bloomberg database

Source: compiled by the authors.

Further, the main results of our research are presented.



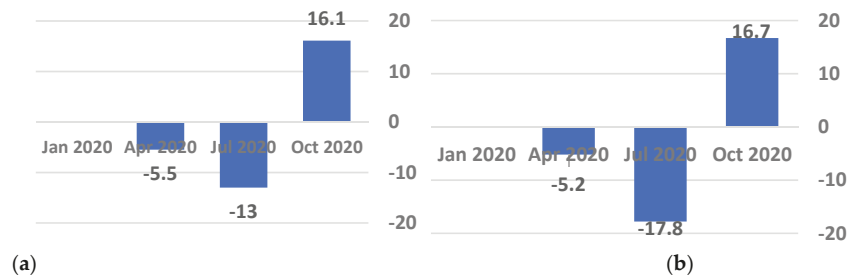
#### 4. Results and Discussion

In this section, the dynamics of Italian and Spanish stock market indexes are analyzed, and the impact of COVID-19 on Italian and Spanish stock markets is evaluated.

##### 4.1. Trends of Italian and Spanish Stock Markets

In the case of Italy, the COVID-19 pandemic had the biggest effects in Europe on countries' economies and financial markets during the first two quarters of 2020. By the end of December 2020, more than two million ([World Meters 2021](#)) got sick with the virus.

From Figure 1a, it is possible to conclude that the pandemic affected the country in two waves: the first wave spread from March 2020 to May 2020; the second one started from October 2020 and it is still ongoing. While the country was in lockdown, which did help to decrease the new cases of infection, the quarantine had severe consequences for economic effect, for example, the gross domestic product (GDP) in Italy shrunk by 13% by the end of the second quarter of 2020, making it was one of the largest drops in the country's history (see Figure 2a).



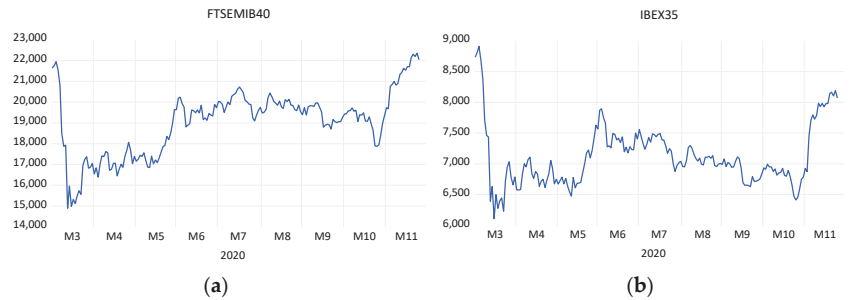
**Figure 2.** GDP growth rate in Italy (Panel a) and Spain (Panel b) in 2020. Source: compiled by the authors on the basis of Trading Economics 2020.

Spain was the second most affected country in Europe by COVID-19 during the first pandemic wave. According to the graph below (see Figure 1b), there were more than one and a half million confirmed coronavirus cases in Spain up until December 2020. During the first lockdown, the GDP growth rate in Spain shrunk by 17.8%, which is 4.8% more than in Italy. However, in the third quarter, the rate increased by 16.7% (see Figure 2b), and increasing consumer spending contributed significantly to the GDP.

The dynamics of selected Italian and Spanish stock market indexes during the whole period (covering Periods 1–3, 1 March 2020–30 November 2020) are provided in Figure 3a,b. At the end of the 1st quarter of the year 2020, when the spread of the COVID-19 pandemic was observed in Europe as well, the European stock markets experienced a sudden and strong shock. As it can be seen from Figure 3, the Italian and Spanish stock markets were no exception either—the significant negative shift in terms of index value can be observed in March 2020. Moreover, FTSE MIB 40 fell by 11% on the 9 March, while IBEX 35 fell by 14% on 12 March; this was recorded as the highest drop in history for one day ([Camarero 2020](#)).

However, after a significant negative shift, observed in the 1st quarter of 2020, Italian and Spanish stock markets regained an upward trend. The second wave of the COVID-19 pandemic was followed by a decrease in index values at the beginning of the 4th quarter of 2020; however, this decline was temporary in nature, and markets adjusted much faster than during the first wave of the pandemic.

Further, the impact of the spread of the COVID-19 pandemic is assessed.



**Figure 3.** Dynamics of FTSE MIB 40 (Panel a) and IBEX 35 (Panel b) indexes, 1 March 2020–30 November 2020. Source: compiled by the authors on the basis of Bloomberg database data. Note: M1 = January; M2 = February; M3 = March; M4 = April; M5 = May; M6 = June; M7 = July; M8 = August; M9 = September; M10 = October; M11 = November; for variable abbreviations, see Table 1.

4.2. Assessment of the Impact of the COVID-19 Pandemic on Italian and Spanish Stock Markets

4.2.1. OLS Regression and Heteroscedasticity-Corrected Models

As a starting point, it was attempted to assess the impact of the spread of the COVID-19 pandemic on Italian and Spanish stock markets using simple bivariate (OLS) regression models. Descriptive statistics of OLS regression model variables are provided in Table 2.

**Table 2.** Descriptive statistics of OLS regression model variables.

	GrNCIT <sub>t</sub>	GrNCSP <sub>t</sub>	LnFTSEMIB40 <sub>t</sub>	LnIBEX35 <sub>t</sub>	VIX <sub>t</sub>
Mean	0.071	0.231	9.849	8.867	32.639
Median	0.075	0.106	9.873	8.854	28.135
Maximum	4.106	2.811	10.015	9.095	82.690
Minimum	−2.493	−0.807	9.608	8.717	20.570
Std. Dev.	0.511	0.708	0.084	0.066	11.939
Skweness	2.237	1.110	−0.580	0.904	2.047
Kurtosis	26.066	4.246	3.041	4.095	7.129
Jarque-Bera	4416.534	48.610	10.844	35.949	267.637
Probability	0.000	0.000	0.000	0.000	0.000
Sum	13.650	41.615	1901.000	1711.416	6201.470
Sum Sq. Dev.	49.852	89.755	1.361	0.846	26,939.98
Observations	192	192	193	193	190

Source: compiled by the authors. Note: Std. Dev.—Standard Deviation; for variable abbreviations, see Table 1.

The results of the Augmented Dickey–Fuller test are presented in Table 3. As can be seen from the table, in the case of selected variables the hypothesis of the presence of a unit root can be rejected, i.e., variables are stationary and can be used in further analysis. Two variables (VIX<sub>t</sub> and NCSP<sub>t</sub>) appeared to be not stationary in level; thus, in further research, they are used in differences.

Further primary OLS regression models are constructed for each pair of dependent and independent variables and each period (including the whole period). After constructing OLS regression models, they are checked for the heteroscedasticity and residuals using the ARCH-LM test. The results of this test are provided in Table 4.

As can be seen from Table 4, the hypothesis of ARCH effect not existing is rejected, i.e., the presence of the ARCH effect is confirmed. Taking this into account, the HAC is employed, and heteroscedasticity-corrected models are created (both primary OLS regression models and heteroscedasticity-corrected models are provided in Tables 5–8).

**Table 3.** Results of unit-root (Augmented Dickey–Fuller) test.

Variable	Augmented Dickey–Fuller Test Statistic	1% Level	5% Level	10% Level
LnFTSEMIB40 <sub>t</sub>	−5.039 **	−4.008	−3.434	−3.141
LnIBEX35 <sub>t</sub>	−4.207 **	−4.008	−3.434	−3.141
GrNCIT <sub>t</sub>	−7.516 **	−4.008	−3.434	−3.141
GrNCSP <sub>t</sub>	−4.419 **	−4.020	−3.440	−3.144
VIX <sub>t</sub>	−2.149	−3.466	−2.877	−2.575
D(VIX <sub>t</sub> )	−19.944 **	−3.466	−2.877	−2.575
RFTSEMIB40 <sub>t</sub>	−15.140 **	−3.465	−2.877	−2.575
RIBEX35 <sub>t</sub>	−14.702 **	−3.465	−2.877	−2.575
NCIT <sub>t</sub>	−6.475 **	−3.465	−2.878	−2.576
NCSP <sub>t</sub>	−0.325	−3.480	−2.883	−2.578
D(NCSP <sub>t</sub> )	−4.054 **	−3.476	−2.882	−2.578

Source: compiled by the authors. \*\* 99% c.l. Note: for variable abbreviations, see Table 1.

**Table 4.** Results of heteroscedasticity test: ARCH effects.

Dependent Variable		Whole Period		
lnFTSEMIB40 <sub>t</sub>	F-statistic	573.915	Prob. F(1,189)	0.000 **
	Obs*R-squares	140.272	Prob. Chi-Square(1)	0.000 **
lnIBEX35 <sub>t</sub>	F-statistic	1424.338	Prob. F(1,166)	0.000 **
	Obs*R-squares	150.464	Prob. Chi-Square(1)	0.000 **
<b>Period 1</b>				
lnFTSEMIB40 <sub>t</sub>	F-statistic	167.865	Prob. F(1,61)	0.000 **
	Obs*R-squares	46.208	Prob. Chi-Square(1)	0.000 **
lnIBEX35 <sub>t</sub>	F-statistic	254.742	Prob. F(1,50)	0.000 **
	Obs*R-squares	43.468	Prob. Chi-Square(1)	0.000 **
<b>Period 2</b>				
lnFTSEMIB40 <sub>t</sub>	F-statistic	48.663	Prob. F(1,61)	0.000 **
	Obs*R-squares	27.956	Prob. Chi-Square(1)	0.000 **
lnIBEX35 <sub>t</sub>	F-statistic	78.415	Prob. F(1,61)	0.000 **
	Obs*R-squares	35.434	Prob. Chi-Square(1)	0.000 **
<b>Period 3</b>				
lnFTSEMIB40 <sub>t</sub>	F-statistic	11.457	Prob. F(1,55)	0.001 **
	Obs*R-squares	9.826	Prob. Chi-Square(1)	0.002 **
lnIBEX35 <sub>t</sub>	F-statistic	11.527	Prob. F(1,49)	0.001 **
	Obs*R-squares	9.713	Prob. Chi-Square(1)	0.002 **

Source: compiled by the authors. \*\* 99% c.l., \* multiplication sign. Note: for variable abbreviations, see Table 1.

As can be seen from Table 5, consistent with the results of previous studies (see Section 2), VIX was confirmed to have a statistically significant negative effect on the values of selected stock indexes. The results in Table 5 also allow us to state that neither OLS regression models nor heteroscedasticity-corrected models have shown a statistically significant impact of the spread of the COVID-19 pandemic on the values of FTSE MIB 40 and IBEX 35 indexes. Moreover, such analysis does not allow one to assess differences of market response at different stages of the spread of a pandemic, which is why, if one is seeking to examine this effect in greater depth, the analysis of market reactions at separate stages or periods is necessary (the results of which can be seen in Tables 6–8).

Interestingly, both OLS regression and heteroscedasticity-corrected models have revealed a positive market reaction to the growth of new daily cases of COVID-19 in the case of Italy in Period 1, even under the control of the selected control variable; the effect of WIX appeared to be negative (Table 6).

**Table 5.** Results of regression analysis for FTSE MIB 40 and IBEX 35 (whole period—1 March 2020–30 November 2020).

	Coefficient	Std. Error	t-Value	p-Stat	R sq.	Observ.
Ordinary least squares regression models						
<b>lnFTSEMIB40<sub>t</sub></b>						
C	10.023	0.011	884.923	0.000 **		
grNCIT <sub>t</sub>	0.007	0.008	0.909	0.364		
VIX <sub>t</sub>	−0.005	0.0003	−16.534	0.000 **	0.595	189
<b>lnIBEX35<sub>t</sub></b>						
C	8.936	0.013	669.193	0.000 **		
grNCSP <sub>t</sub>	0.003	0.007	0.536	0.593		
VIX <sub>t</sub>	−0.002	0.0003	−5.649	0.000 **	0.156	177
Heteroscedasticity-corrected models						
<b>lnFTSEMIB40<sub>t</sub></b>						
C	10.023	0.017	602.429	0.000 **		
grNCIT <sub>t</sub>	0.007	0.007	1.038	0.301		
VIX <sub>t</sub>	−0.005	0.0004	−12.255	0.000 **	0.595	189
<b>lnIBEX35<sub>t</sub></b>						
C	8.937	0.020	437.532	0.000 **		
grNCSP <sub>t</sub>	0.003	0.007	0.408	0.684		
VIX <sub>t</sub>	−0.002	0.001	−4.098	0.000 **	0.156	177

Source: compiled by the authors. \*\* 99% c.l. Note: Std. Error—Standard Error; p-Stat = p-Statistics; R sq. = R squared; Observ. = Observations; for variable abbreviations, see Table 1.

**Table 6.** Results of regression analysis for FTSE MIB 40 and IBEX 35 (Period 1—1 March 2020–29 May 2020).

	Coefficient	Std. Error	t-Value	p-Stat	R sq.	Observ.
Ordinary least squares regression models						
<b>lnFTSEMIB40<sub>t</sub></b>						
C	9.894	0.024	413.009	0.000 **		
grNCIT <sub>t</sub>	0.04	0.021	2.012	0.049 *		
VIX <sub>t</sub>	−0.003	0.001	−5.963	0.000 **	0.378	64
<b>lnIBEX35<sub>t</sub></b>						
C	8.914	0.032	275.989	0.000 **		
grNCSP <sub>t</sub>	0.015	0.013	1.122	0.267		
VIX <sub>t</sub>	−0.002	0.001	−2.484	0.016 *	0.122	56
Heteroscedasticity-corrected models						
<b>lnFTSEMIB40<sub>t</sub></b>						
C	9.894	0.035	281.746	0.000 **		
grNCIT <sub>t</sub>	0.04	0.040	2.011	0.049 *		
VIX <sub>t</sub>	−0.003	0.001	−4.787	0.000 **	0.378	64
<b>lnIBEX35<sub>t</sub></b>						
C	8.914	0.045	197.004	0.000 **		
grNCSP <sub>t</sub>	0.015	0.016	0.904	0.369		
VIX <sub>t</sub>	−0.002	0.001	−2.194	0.000 **	0.122	56

Source: compiled by the authors. \*\* 99% c.l., \* 95% c.l. Note: Std. Error—Standard Error; p-Stat = p-Statistics; R sq. = R squared; Observ. = Observations; for variable abbreviations, see Table 1.

**Table 7.** Results of regression analysis for FTSE MIB 40 and IBEX 35 (Period 2—1 June 2020–31 August 2020).

	Coefficient	Std. Error	t-Value	p-Stat	R sq.	Observ.
Ordinary least squares regression models						
<b>lnFTSEMIB40<sub>t</sub></b>						
C	9.964	0.014	711.051	0.000 **		
grNCIT <sub>t</sub>	−0.001	0.003	−0.358	0.722		
VIX <sub>t</sub>	−0.003	0.001	−5.210	0.000 **	0.305	65
<b>lnIBEX35<sub>t</sub></b>						
C	8.831	0.023	378.534	0.000 **		
grNCSP <sub>t</sub>	−0.0002	0.005	−0.054	0.966		
VIX <sub>t</sub>	0.002	0.001	2.578	0.012 *	0.098	65
Heteroscedasticity-corrected models						
<b>lnFTSEMIB40<sub>t</sub></b>						
C	9.965	0.019	514.795	0.000 **		
grNCIT <sub>t</sub>	−0.001	0.002	−0.649	0.519		
VIX <sub>t</sub>	−0.003	0.001	−4.080	0.000 **	0.304	65
<b>lnIBEX35<sub>t</sub></b>						
C	8.832	0.029	307.589	0.000 **		
grNCSP <sub>t</sub>	−0.0003	0.004	−0.701	0.943		
VIX <sub>t</sub>	0.002	0.001	2.366	0.021 *	0.098	65

Source: compiled by the authors. \*\* 99% c.l., \* 95% c.l. Note: Std. Error—Standard Error; p-Stat = p-Statistics; R sq. = R squared; Observ. = Observations; for variable abbreviations, see Table 1.

**Table 8.** Results of regression analysis for FTSE MIB 40 and IBEX 35 (Period 3—1 September 2020–30 November 2020).

	Coefficient	Std. Error	t-Value	p-Stat	R sq.	Observ.
Ordinary least squares regression models						
<b>lnFTSEMIB40<sub>t</sub></b>						
C	10.184	0.028	359.197	0.000 **		
grNCIT <sub>t</sub>	−0.027	0.022	−1.216	0.229		
VIX <sub>t</sub>	−0.011	0.001	−10.268	0.000 **	0.672	60
<b>lnIBEX35<sub>t</sub></b>						
C	9.202	0.041	226.248	0.000 **		
grNCSP <sub>t</sub>	−0.007	0.009	−0.689	0.494		
VIX <sub>t</sub>	−0.012	0.001	−8.409	0.000 **	0.573	56
Heteroscedasticity-corrected models						
<b>lnFTSEMIB40<sub>t</sub></b>						
C	10.184	0.050	203.434	0.000 **		
grNCIT <sub>t</sub>	−0.027	0.015	−1.717	0.091 ^		
VIX <sub>t</sub>	−0.011	0.002	−6.144	0.000 **	0.672	60
<b>lnIBEX35<sub>t</sub></b>						
C	9.203	0.082	112.302	0.000 **		
grNCSP <sub>t</sub>	−0.007	0.006	−1.060	0.294		
VIX <sub>t</sub>	−0.012	0.003	−4.366	0.000 **	0.573	56

Source: compiled by the authors. \*\* 99% c.l., ^ 90% c.l. Note: Std. Error—Standard Error; p-Stat = p-Statistics; R sq. = R squared; Observ. = Observations; for variable abbreviations, see Table 1.

Quite a different situation can be observed in Period 2 (Table 7) when the effect of the control variable, VIX, turned to be positive, and no statistically significant reaction to the

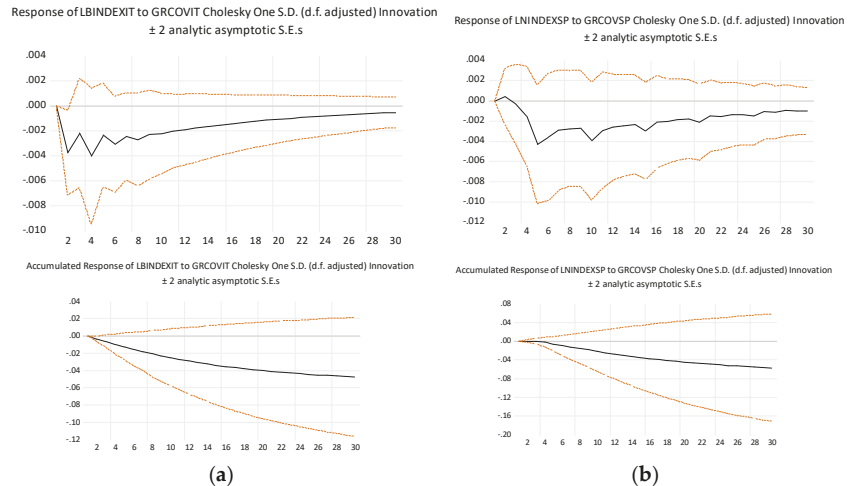
spread of the COVID-19 pandemic can be observed. After the primary shock in Period 1, the uncertainty in the market decreased.

The analysis of the results of both OLS regression models and heteroscedasticity-corrected models for Period 3 does not reveal the statistically significant impact of the COVID-19 pandemic on the Spanish stock market. However, in Period 3 or the onset of the second wave of the pandemic, the growth of new daily reported cases of the infection appeared to have a statistically significant impact on Italy’s stock market (see Table 8), but only at 90% confidence level. Since the uncertainty in the equity markets increased again, the impact of VIX has proved to be negative on both Italy’s and Spain’s stock markets.

Since the results of this stage do not provide clear evidence of pandemic impact on stock markets, we seek to determine the short-term response of selected indexes representing Italy’s and Spain’s stock markets to the spread of the COVID-19 pandemic using impulse response functions.

#### 4.2.2. VAR-Based Impulse Response Functions

As a starting point, the baseline VAR models, using one dependent and one independent variable mentioned in the previous section, are employed. The results of VAR estimation are provided in Appendices A, C, E and G, while lag selection criteria can be seen in Appendices B, D, F and H. Based on these VAR models, the impulse response functions as well as accumulated impulse response functions are created (Figures 4–7). The analysis of these figures allows us to make certain assumptions regarding the direction, strength, and duration of the primary response of FSTE MIB 40 and IBEX 35 indexes in the face of the COVID-19 pandemic.

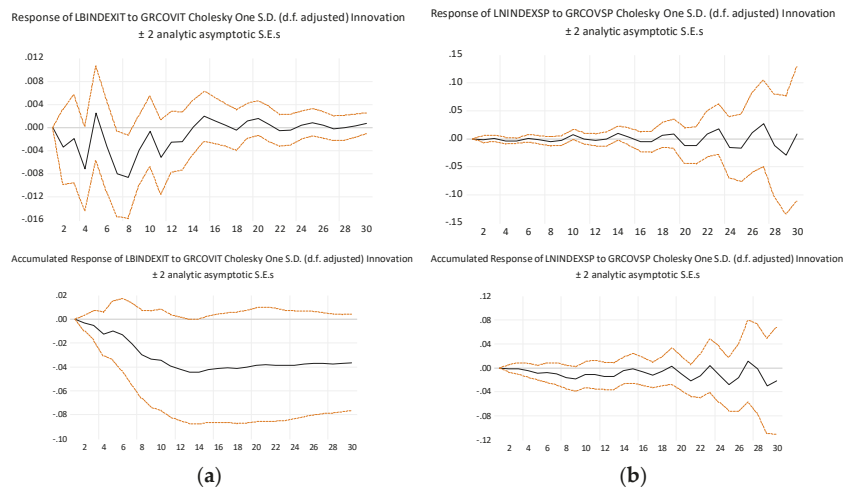


**Figure 4.** Response of FTSE MIB 40 (Panel a) and IBEX 35 (Panel b) indexes to the spread of the COVID-19 pandemic (whole period). Source: compiled by the authors. Note: for variable abbreviations, see Table 1.

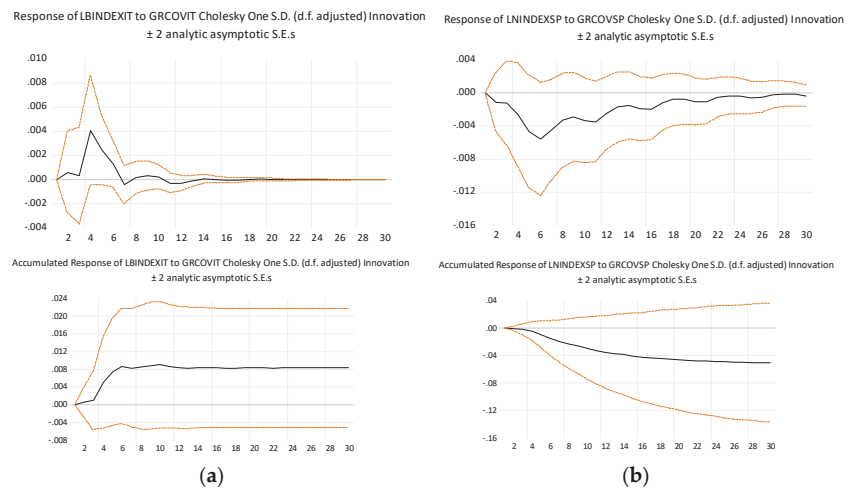
Figure 4 shows the dynamic effects of the growth of COVID-19 cases on the FSTE MIB 40 and IBEX 35 indexes taking into account the whole period. As can be seen, the impulse response functions constructed for the whole period indicate the primary negative response of both FSTE MIB 40 and IBEX 35 indexes in the face of the COVID-19 pandemic. Nevertheless, this response tends to weaken over time and approaches close to zero on day 30. However, the accumulated response appeared to be increasingly negative.

This allows us to assume that the stock markets of Italy and Spain were negatively affected during the early spread of the COVID-19 pandemic. As is stated by World Bank,

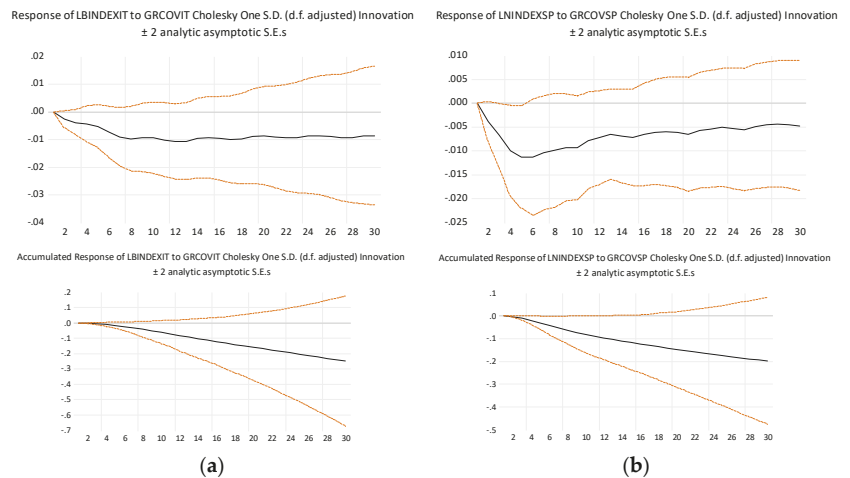
both Italy and Spain were unprepared for such a massive pandemic; thus, the rapid spread of the COVID-19 pandemic had led to lockdown all across Italy and Spain. According to Sanfelici (2020), even though the rapid actions of the government of Italy were taken, the health crisis and lack of planning and communication resulted in policy framework chaos. The first gradual lockdown in Italy was in order on the 23 February, whereas in Spain this was only on the 29 March after the outbreak of the official death toll in Italy, which surpassed that of mainland China (Davies 2020).



**Figure 5.** Response of FTSE MIB 40 (Panel a) and IBEX 35 (Panel b) indexes to the spread of the COVID-19 pandemic (Period 1—1 March 2020–31 May 2020). Source: compiled by the authors. Note: for variable abbreviations, see Table 1.



**Figure 6.** Response of FTSE MIB 40 (Panel a) and IBEX 35 (Panel b) indexes to the spread of the COVID-19 pandemic (Period 2—0 June 2020–30 August 2020). Source: compiled by the authors. Note: for variable abbreviations, see Table 1.



**Figure 7.** Response of FTSE MIB 40 (Panel a) and IBEX 35 (Panel b) indexes to the spread of the COVID-19 pandemic (Period 3—1 September 2020–30 November 2020). Source: compiled by the authors. Note: for variable abbreviations, see Table 1.

Figure 5 shows the dynamic effects of the growth of COVID-19 cases on the FTSE MIB 40 and IBEX 35 indexes taking into account Period 1, i.e., the first stage of the pandemic.

As can be seen from Figure 5, the primary response to the COVID-19 pandemic is of inconstant strength and nature; moreover, it slightly differs depending on the country analyzed. In the case of the Italian stock market, the primary response is negative but inconstant, while the accumulated response is negative. In the case of the Spanish stock market, both primary response and accumulated response are close to zero on day 1 and start to fluctuate later on.

Figure 6 shows the dynamic effects of the growth of COVID-19 cases on the FTSE MIB 40 and IBEX 35 indexes taking into account Period 2, i.e., the recovery period.

As can be seen from Figure 6, the market reaction during Period 2 differs from the reaction in Period 1 in both Italy and Spain. (i) The initial response of the FTSE MIB 40 index to the spread of the COVID-19 pandemic appeared to be clearly positive, while the initial response of the IBEX 35 index is clearly negative; however, in both cases, the primary response tends to weaken over time and approaches zero in day 20 and 28, respectively. (ii) The accumulated response also differs depending on the country—in the case of Italy, it is positive, while in the case of Spain—negative.

Period 2 can be characterized as the summer season in which the recovery and preparations for the predicted second wave were implied and executed by the governments. During Period 1, Italy had in total 231,869 confirmed cases of COVID-19, while in Period 2 numbers drastically decreased to 36,217 (a decrease of 84.38%). At the same time, the situation in Spain was slightly different: in Period 1, the total number of confirmed cases of COVID-19 was 239,434, and in Period 2 this was 223,379 (a decrease of only 6.71%). Therefore, the results for Period 2 still show a negative impact in the case of Spain.

Different situations in Italy and Spain can be explained by several facts. First of all, during the summer period, Italy's health system was rebuilt and the COVID-19 testing was quite successful; initially one of the most virus-affected countries, Italy managed to become one of the most successful examples compared to other countries during June, July and August of 2020. Secondly, Italy was one of the first countries that implemented the regional lockdowns around the country; according to Cartabellotta, President of the GIMBE health foundation (Ians 2021), the mobile hospitals had a major impact on the improvements rather than just using the hospital buildings; moreover, according to the Draghi, the Prime Minister of Italy (Ians 2021), the country's vaccine rollout strategy was efficient. Thirdly,



Spain faced the COVID-19 pandemic later than Italy; furthermore, the installments of mobile hospitals and virus-controlling strategies also took more time in the later dates in comparison with Italy. Thus, it is possible to conclude that during Period 2, Italy not only reduced its number of confirmed cases of COVID-19 but also demonstrated a sharper recovery of the stock market than Spain. The successful implementation of the government strategies and policies brought effective results, and the research results (Figures 5 and 6) also contribute to the evidence.

Figure 7 shows the dynamic effects of the growth of COVID-19 cases on the FSTE MIB 40 and IBEX 35 indexes, taking into account Period 3, i.e., the onset of the second wave of the pandemic.

As is seen from Figure 7, the impulse response functions constructed for Period 3 indicate both primary and accumulated negative response of both FSTE MIB 40 and IBEX 35 indexes in the face of the COVID-19 pandemic; moreover, this response is of a much more constant nature than in previous periods.

Taking this into account, it can be said that the analysis of VAR-based impulse response functions revealed the non-zero response of selected stock market indexes to the spread of the COVID-19 pandemic. Moreover, this response varies in direction, strength, and duration depending on the country and period analyzed.

#### 4.2.3. GARCH Models

Further, the impact of the COVID-19 pandemic is being analyzed using the GARCH model and using the index return volatility approach.

Figure 8 shows the daily values of FTSE MIB 40 and IBEX 35 index returns calculated using Equation (1). As can be seen from the figure, the returns at the very beginning and the very end of the whole period analyzed are much more volatile than in the rest of the period.

Descriptive statistics of selected dependent (index return) and independent (COVID-19 cases) variables are provided in Table 9.

The data are further checked for stationarity. The results of the Augmented Dickey–Fuller test are presented in Table 3. As can be seen from Table 9, the returns of selected indexes are negatively skewed, i.e., demonstrating left-sided asymmetry. The density plots for daily logarithm returns are shown in Figure 9.

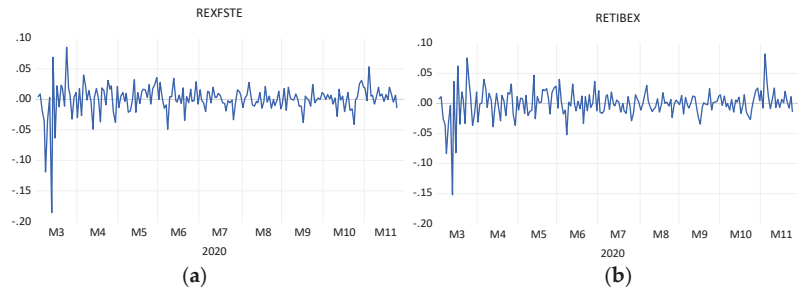
The quantile–quantile plots of logarithm return of selected indexes are shown in Figure 10. As can be seen from the figure, the distribution of returns of selected indexes differs from the normal (theoretical) distribution.

After checking for the ARCH effect (Appendix M), we can conclude that, in the case of the return of selected indexes, the ARCH effect is present only in the whole period. As the presence of the ARCH effect can be considered a precondition for the development of the GARCH model, the HAC method is employed and GARCH models are created only for the previously mentioned case, i.e., the whole period, in which the ARCH effect is observed (results of GARCH estimations are provided in Table 10). For other pairs of variables, only OLS models are analyzed. OLS regression models, as well as heteroscedasticity-corrected models, are provided in Appendices I–L. None of these models revealed a statistically significant impact of the spread of the COVID-19 pandemic on the changes of the returns of selected stock market indexes (see Appendices I–L). The exception was Period 1 and Period 2 for Italy, where the positive and negative impact (respectively) of the spread of the COVID-19 pandemic was observed. However, models confirmed the negative effect of the control variable—VIX.

The GARCH estimations for FSTEMIB40 and IBEX 35 indexes return in the whole period approach are provided in Table 10.

The results in Table 10 reveal a statistically significant GARCH effect and a positive impact of the daily number of COVID-19 cases in the case of the Spanish stock market. A statistically significant GARCH effect is also observed in the case of the Italian stock market. This allows us to state that the spread of the COVID-19 pandemic appeared to

have a statistically significant impact on the volatility of the return of stock market indexes analyzed. These results are consistent with those of Shehzad et al. (2020) and Chaudhary et al. (2020). (Note: it also can be seen from Table 10 that in the case of the Italian stock market, the GARCH (1,1) is not best suited, as it has negative and statistically insignificant parameters.)

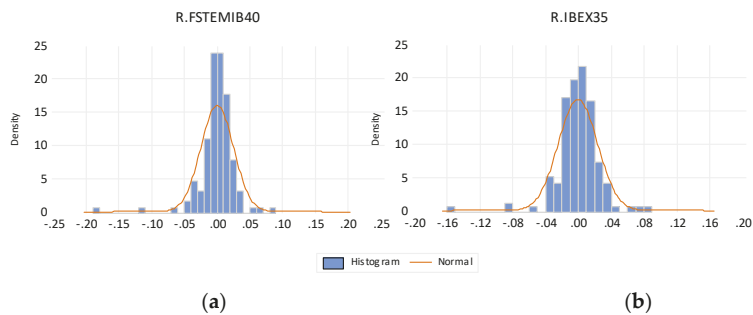


**Figure 8.** Daily values of FTSE MIB 40 (Panel a) and IBEX 35 (Panel b) logarithmic returns. Source: compiled by the authors. Note: M1 = January; M2 = February; M3 = March; M4 = April; M5 = May; M6 = June; M7 = July; M8 = August; M9 = September; M10 = October; M11 = November; for variable abbreviations, see Table 1.

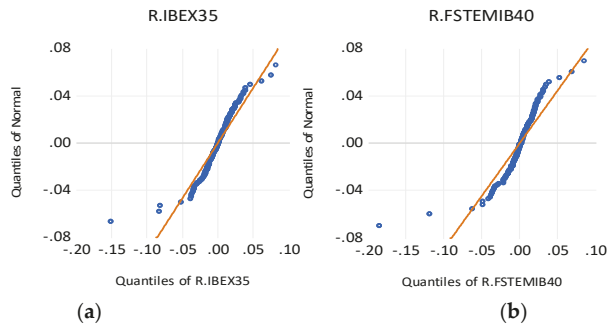
**Table 9.** Descriptive statistics of GARCH model variables.

	NCIT <sub>t</sub>	NCSP <sub>t</sub>	R.FTSEMIB40 <sub>t</sub>	R.IBEX35 <sub>t</sub>	VIX <sub>t</sub>
Mean	5730.802	8451.139	$9.67 \times 10^{-5}$	-0.001	32.639
Median	1401.500	5103.000	0.002	0.001	28.135
Maximum	40,902.000	55,019.000	0.085	0.082	82.690
Minimum	113.000	36.000	-0.185	-0.152	20.570
Std. Dev.	9988.731	10,222.710	0.028	0.024	11.939
Skweness	2.113	2.027	-2.559	-1.280	2.047
Kurtosis	6.140	7.998	21.004	12.304	7.129
Jarque-Bera	221.841	322,731	2802.559	745.012	267.637
Probability	0.000	0.000	0.000	0.000	0.000
Sum	1,100,314.00	1,580,363.0	0.019	-0.079	6201.470
Sum Sq. Dev.	$1.90 \times 10^{10}$	$1.94 \times 10^{10}$	0.118	0.109	26,939.98
Observations	192	187	192	192	190

Source: compiled by the authors. Note: Std. Dev.—Standard Deviation; for variable abbreviations, see Table 1.



**Figure 9.** Density plots for daily logarithm returns of FTSE MIB 40 (Panel a) and IBEX 35 (Panel b) returns. Source: compiled by the authors. Note: for variable abbreviations, see Table 1.



**Figure 10.** Q–Q plots for daily logarithm returns of FTSE MIB 40 (Panel b) and IBEX 35 (Panel a) returns. Source: compiled by the authors. Note: for variable abbreviations, see Table 1.

**Table 10.** GARCH estimations for the whole period (1 March 2020–30 November 2020).

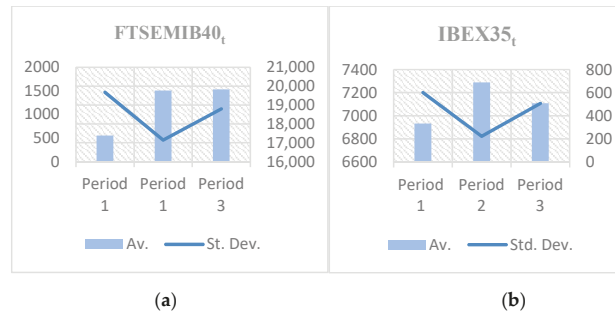
Variable	Coefficient	Std. Error	z-Statistic	p-Stat	R sq.	Observ.
<b>Dependent Variable: RetFSTEMIB40<sub>t</sub></b>						
C	−0.001	0.001	−0.455	0.649		
NCSPt	$1.04 \times 10^{-7}$	$1.21 \times 10^{-7}$	0.858	0.391		
VIXt	−0.003	0.0004	−9.436	0.000 **		
<b>Variance Equation</b>						
C	$1.34 \times 10^{-6}$	$4.51 \times 10^{-6}$	0.297	0.766		
RESID(−1) <sup>2</sup>	−0.017	0.013	−1.303	0.193		
GARCH(−1)	1.005	0.035	28.895	0.000 **	0.363	196
<b>Dependent Variable: RetIBEX35<sub>t</sub></b>						
C	0.0001	0.001	0.094	0.925		
NCSPt	$2.19 \times 10^{-7}$	$8.95 \times 10^{-8}$	2.443	0.014 **		
VIX <sub>t</sub>	−0.003	0.0003	−7.933	0.000 **		
<b>Variance Equation</b>						
C	$2.66 \times 10^{-5}$	$1.78 \times 10^{-5}$	1.489	0.134		
RESID(−1) <sup>2</sup>	0.125	0.067	1.979	0.041 *		
GARCH(−1)	0.800	0.099	8.085	0.000 **	0.279	192

Source: compiled by the authors. \*\* 99% c.l., \* 95% c.l. Note: Std. Error—Standard Error; p-Stat = p-Statistics; R sq. = R squared; Observ. = Observations; for variable abbreviations, see Table 1.

#### 4.3. Discussion of the Results, Limitations, and Directions for Future Research

Figure 11 presents the average volatility measured by the standard variation of Italian and Spanish stock indexes during three analyzed periods.

As can be seen from Figure 11, from Period 1 to Period 2, the volatility of the FTSE MIB 40 index decreased by more than three times, while the volatility of the IBEX 35 index decreased by more than two times. These results allow us to state the following: (i) after the initial negative shock in Period 1 (the first wave of the COVID-19 pandemic), both the Italian and Spanish stock markets showed significant signs of recovery as the index values rose on average by 13.76% and 5.26%, respectively; (ii) the Italian stock market demonstrated higher growth than the Spanish stock market; (iii) the substantial decrease in volatility in both markets in Period 2 shows that stock markets have adjusted at a certain degree, and the uncertainty, caused inter alia by the rapid spread of the COVID-19 pandemic, decreased substantially; (iv) during the recovery (or so-called quiet period), uncertainty declined more in the Italian than in the Spanish stock market (these results are at least partially confirmed by the results in impulse response function analysis).



**Figure 11.** Stock market index volatility in Italy (Panel a) and Spain (Panel b) in Periods 1–3. Source: compiled by the authors. Note: Av. = Average; Std. Dev. = Standard Deviation; for variable abbreviations, see Table 1.

Compared to Period 2, in Period 3, volatility increased in both Italian and Spanish stock markets; nevertheless, it appeared to be lower in Period 3 than in Period 1. It is important to note, in comparison with Period 2, that uncertainty in Period 3 increased in both Italian and Spanish markets; nevertheless, during the beginning and middle stages of the second wave of the COVID-19 pandemic (Period 3), both markets were more stable and displayed a lower degree of uncertainty compared to the first wave (Period 1). These results were quite expected because, as mentioned before, during a recovery period (Period 2), there was a favorable time for markets to stabilize and prepare for upcoming higher increases in new COVID-19 cases during the second wave of the pandemic.

The results of this research revealed that the stock market reaction to the spread of the COVID-19 pandemic differs depending on the country and period analyzed. OLS regression and heteroscedasticity-corrected models have not revealed the statistically significant impact of the spread of the COVID-19 pandemic, i.e., the impact appeared to be ambiguous. This mixed (ambiguous) effect of the COVID-19 pandemic was also revealed by [Albulescu \(2020\)](#) who analyzed the impact of rising COVID-19 cases and deaths on the volatility of the US stock market.

However, impulse response functions demonstrated the non-zero primary response of analyzed markets to the COVID-19 shock. The primary response during the first and the second wave of the pandemic appeared to be negative in both Italy and Spain. This is consistent with the results obtained by [Ashraf \(2020\)](#), who, using VAR-based impulse response functions, revealed that negative market reaction was strong during the early days of COVID-19 cases confirmed. Using the same approach, the negative response of different stock markets was also confirmed by [Ahundjanov et al. \(2020\)](#) and [Thakur \(2020\)](#). Moreover, the results of impulse response functions revealed that the market reaction was strongest in the first week and weakened later. This is consistent with the results of [Milani \(2021\)](#), which revealed that the peak response to the COVID-19 pandemic usually happens 4–6 days after the shock. [Beirne et al. \(2020\)](#) also confirmed that the duration of shocks varies in the range of 5 to 10 days.

Interestingly, in the case of Italy, the primary response of the stock market appeared to be positive during the recovery period, which coincides with the results of impulse response functions analysis conducted by [Brueckner and Vespignani \(2020\)](#) for the case of Australia.

Finally, GARCH (1;1) models confirmed that the COVID-19 pandemic increased the volatility of stock market return, i.e., the spread of the COVID-19 pandemic appeared to have a statistically significant impact on the volatility of the return of stock market indexes analyzed, which is consistent with the results of [Shehzad et al. \(2020\)](#) and [Chaudhary et al. \(2020\)](#). [Endri et al. \(2020\)](#) also employed GARCH models to prove that stock price volatility increased during the COVID-19 pandemic, which has led to a decrease in returns.

With regard to the contribution of our research, it could be stated that our research covers three separate periods of the COVID-19 pandemic, while a majority of other studies

(for example, [Albulescu 2020](#); [Chaudhary et al. 2020](#); [Gherghina et al. 2021](#); and others) analyze data from a much shorter period. We, in turn, develop the analysis of separate stages of the pandemic and provide a comprehensive impact assessment both during the whole pre-vaccination period of the pandemic and during different stages of this period.

Regarding the limitations of the performed research, it is very important to notice that the research is based on a relatively short data series, and deliberately does not cover the later periods of the pandemic; thus, the effect of vaccination announcements, etc., could be assessed in further studies. On the other hand, this research was aimed at analyzing the stock market response to the COVID-19 pandemic in the short term after its beginnings.

Another research limitation is that the index scenarios were developed on the assumption that they are affected by daily confirmed cases of COVID-19. Other factors, such as mortality rates, unemployment due to the lockdown, travel bans, etc., could also be considered in further studies. The analysis of the impact of the pandemic from the longer-term perspective (as soon as longer data series become available) and the analysis of the impact on Italian and Spanish stock markets, as well as comparison with the impact in other countries, could also be directions for further research.

## 5. Conclusions

This research contributes to the existing literature, as it assesses the impact of the spread of the COVID-19 pandemic during the whole pre-vaccination period of the pandemic and as well as in different stages of this period using different approaches.

The results of this research allow for concluding that the impact of the spread of the COVID-19 pandemic differs depending on the country and period analyzed.

OLS regression and heteroscedasticity-corrected models have not revealed the statistically significant impact of the spread of the COVID-19 pandemic, while impulse response functions demonstrated the non-zero primary response of analyzed markets to the COVID-19 shock, and GARCH models confirmed that the COVID-19 pandemic increased the volatility of stock market return.

Finally, the results of the research have shown that the spread of the COVID-19 pandemic caused the increase in uncertainty in the stock markets analyzed, but this increase was of a temporary nature. Moreover, the second wave of the pandemic has not affected the market volatility so drastically as during the first wave of the pandemic.

It should be noted that this research is based on a relatively short data series, from three periods of the year 2020. This was chosen seeking to focus on analyzing the stock market response to the COVID-19 pandemic in the short term after its beginnings. Thus, this research analyzes the impacts and consequences of the COVID-19 pandemic during the pre-vaccination period. In this way, the research data are equally compared without any new drastic (decisive) factors that shifted the pandemic statistical factors. Further studies are necessary to cover the periods of vaccination and detection and the spread of new variants of COVID-19.

From the academic perspective, this research is valuable, as it develops the analysis of separate stages of the pandemic and provides a comprehensive impact assessment both during the whole pre-vaccination period of the pandemic and during different stages of this period.

From the practical perspective, the study assists with insights into how indexes shifted during the COVID-19 pandemic and how they reacted during specific periods. For example, one of the possible directions for scientists and professionals in the field would be to retrospectively examine the effects and consequences of the pandemic to selected FTSE MIB 40 and IBEX 35 indexes and, in years to come, to create algorithms for future predictions for such unforeseen and unusual disasters.

The findings of this research can be useful for policymakers by providing clues for decision making in the future (taking into account the direction and duration of the impact of the spread of the COVID-19 pandemic). Investors can also benefit from these results, as they identified the negative stock market reaction during the periods of the intense spread of the COVID-19 pandemic. This shows that, in similar future situations, with high market

volatility and uncertainty, specific risk and return management (modification) decisions should be made.

**Author Contributions:** Conceptualization, G.K.-S.; methodology, G.K.-S.; software, G.K.-S.; validation, G.K.-S.; formal analysis, G.K.-S. and J.K.; investigation, G.K.-S. and J.K.; resources, G.K.-S. and J.K.; data curation, G.K.-S.; writing—original draft preparation, G.K.-S. and J.K.; writing—review and editing, G.K.-S.; visualization, G.K.-S. and J.K.; supervision, G.K.-S. All authors have read and agreed to the published version of the manuscript.

**Funding:** This research received no internal funding.

**Conflicts of Interest:** The authors declare no conflict of interest.

**Appendix A**

**Table A1.** Results of VAR Estimation for FTSE MIB 40 and IBEX 35 (Whole Period).

	Italy		Spain		
	lnFTSEMIB40 <sub>t</sub>	grNCIT <sub>t</sub>	lnIBEX35 <sub>t</sub>	grNCSP <sub>t</sub>	
lnFTSEMIB40 <sub>t</sub> (-1)	0.883 (0.072) [12.228]	0.117 (1.451) [0.081]	lnIBEX35 <sub>t</sub> (-1)	0.943 (0.088) [10.775]	-2.209 (2.511) [-0.879]
lnFTSEMIB40 <sub>t</sub> (-2)	0.331 (0.095) [3.472]	-2.308 (1.914) [-1.206]	lnIBEX35 <sub>t</sub> (-2)	0.054 (0.119) [0.455]	3.581 (3.391) [1.056]
lnFTSEMIB40 <sub>t</sub> (-3)	-0.263 (0.072) [-3.633]	2.632 (1.456) [1.807]	lnIBEX35 <sub>t</sub> (-3)	-0.084 (0.119) [-0.701]	-3.059 (3.426) [-0.893]
grNCIT <sub>t</sub> (-1)	-0.008 (0.004) [-2.236]	-0.216 (0.072) [-3.010]	lnIBEX35 <sub>t</sub> (-4)	-0.078 (0.115) [-0.677]	3.929 (3.298) [1.191]
grNCIT <sub>t</sub> (-2)	0.001 (0.004) [0.201]	-0.285 (0.072) [-3.983]	lnIBEX35 <sub>t</sub> (-5)	0.093 (0.083) [1.125]	-2.133 (2.369) [-0.901]
grNCIT <sub>t</sub> (-3)	-0.004 (0.004) [-1.010]	-0.307 (0.072) [-4.313]	grNCSP <sub>t</sub> (-1)	0.001 (0.002) [0.318]	-0.344 (0.077) [-4.499]
C	0.490 (0.213) [2.299]	-4.208 (4.283) [-0.982]	grNCSP <sub>t</sub> (-2)	-0.001 (0.003) [-0.413]	-0.113 (0.077) [-1.474]
R sq.	0.919	0.158	grNCSP <sub>t</sub> (-3)	-0.003 (0.003)	-0.105 (0.080)
Obs.	189		grNCSP <sub>t</sub> (-4)	[-0.952] -0.006 (0.003)	[-1.303] -0.072 (0.086)
			grNCSP <sub>t</sub> (-5)	[-2.049] -0.001 (0.003)	[-0.844] 0.497 (0.079)
			C	[-0.367] 0.602 (0.259) [2.321]	[6.259] -0.680 (7.408) [-0.092]
			R sq.	0.887	0.436
			Obs.	150	

Source: compiled by the authors. Note: R sq. = R squared; Obs. = Observations; standard errors in (); t statistics in []; for variable abbreviations, see Table 1.

Appendix B

Table A2. VAR Lag Order Selection Criteria (Whole Period).

Lag	LogL	LR	FPE	AIC	SC	HQ
lnFTSEMIB40 <sub>t</sub>						
0	67.194	-	0.002	-0.709	-0.674	-0.694
1	340.336	537.377	$9.05 \times 10^{-5}$	-3.634	-3.529	-3.592
2	352.143	22.972	$8.32 \times 10^{-5}$	-3.719	-3.544	-3.648
3	367.003	28.591 *	$7.39 \times 10^{-5}$ *	-3.837 *	-3.593 *	-3.738 *
4	369.313	4.394	$7.53 \times 10^{-5}$	-3.819	-3.504	-3.691
5	373.754	8.351	$7.49 \times 10^{-5}$	-3.823	-3.439	-3.668
6	376.627	5.340	$7.59 \times 10^{-5}$	-3.811	-3.357	-3.627
7	379.239	4.799	$7.70 \times 10^{-5}$	-3.796	-3.272	-3.584
8	382.917	6.676	$7.73 \times 10^{-5}$	-3.793	-3.199	-3.552
lnIBEX35 <sub>t</sub>						
0	70.614	-	0.001	-1.032	-0.998	-1.014
1	220.331	292.679	0.0001	-3.223	-3.093	-3.170
2	224.586	8.191	0.0001	-3.227	-3.009	-3.139
3	226.152	2.967	0.0001	-3.190	-2.886	-3.067
4	240.864	27.433	0.0001	-3.351	-2.960	-3.192
5	258.266	31.925	$9.83 \times 10^{-5}$ *	-3.553 *	-3.074 *	-3.359 *
6	260.004	3.209	0.0001	-3.519	-2.954	-3.289
7	265.768	10.156 *	$9.91 \times 10^{-5}$	-3.545	-2.893	-3.280
8	265.193	0.741	0.0001	-3.491	-2.753	-3.191

Source: compiled by the authors. \* lag orders selected by the criterion. Note: LR = sequential modified LR test statistic (at 5% level); FPE = Final predictor error; AIC = Aikake information criterion; SC = Schwarz information criterion; HQ = Hannan–Quinn information criterion; for variable abbreviations, see Table 1.

Appendix C

Table A3. Results of VAR Estimation for FTSE MIB 40 and IBEX 35 (Period 1).

	Italy		Spain		
	lnFTSEMIB40 <sub>t</sub>	grNCIT <sub>t</sub>	lnIBEX35 <sub>t</sub> (-1)	lnIBEX35 <sub>t</sub>	grNCSP <sub>t</sub>
lnFTSEMIB40 <sub>t</sub> (-1)	0.661 (0.146) [4.518]	-0.723 (1.445) [-0.500]	lnIBEX35 <sub>t</sub> (-1)	0.449 (0.271) [1.647]	-14.946 (6.995) [-2.137]
lnFTSEMIB40 <sub>t</sub> (-2)	0.241 (0.169) [1.422]	2.382 (1.677) [1.419]	lnIBEX35 <sub>t</sub> (-2)	0.087 (0.262) [0.334]	11.135 (6.761) [1.647]
lnFTSEMIB40 <sub>t</sub> (-3)	0.187 (0.163) [1.150]	-1.597 (1.609) [-0.993]	lnIBEX35 <sub>t</sub> (-3)	-0.050 (0.211) [-0.238]	-12.739 (5.447) [-2.339]
lnFTSEMIB40 <sub>t</sub> (-4)	-0.289 (0.158) [-1.836]	0.147 (1.556) [0.095]	lnIBEX35 <sub>t</sub> (-4)	-0.110 (0.230) [-0.479]	11.481 (5.9545) [1.928]
lnFTSEMIB40 <sub>t</sub> (-5)	-0.156 (0.145) [-1.077]	0.2289 (1.427) [0.203]	lnIBEX35 <sub>t</sub> (-5)	0.156 (0.254) [0.612]	-6.213 (6.213) [-0.947]
lnFTSEMIB40 <sub>t</sub> (-6)	-0.207 (0.131) [-1.582]	-0.142 (1.294) [-0.109]	lnIBEX35 <sub>t</sub> (-6)	-0.491 (0.259) [-1.889]	3.193 (6.716) [0.475]
lnFTSEMIB40 <sub>t</sub> (-7)	0.264 (0.113) [2.346]	1.293 (1.109) [1.164]	lnIBEX35 <sub>t</sub> (-7)	0.352 (0.256) [1.377]	0.529 (6.608) [0.080]
grNCIT <sub>t</sub> (-1)	-0.014 (0.014) [-1.041]	-0.552 (0.133) [-4.140]	lnIBEX35 <sub>t</sub> (-8)	-0.119 (0.172) [-0.688]	-6.207 (4.458) [-1.392]
grNCIT <sub>t</sub> (-2)	-0.007 (0.015) [-0.435]	-0.490 (0.149) [-3.279]	grNCSP <sub>t</sub> (-1)	-0.005 (0.010) [-0.462]	-0.816 (0.264) [-3.095]
grNCIT <sub>t</sub> (-3)	-0.027 (0.013) [-2.032]	-0.182 (0.131) [-1.387]	grNCSP <sub>t</sub> (-2)	-0.001 (0.011) [-0.076]	-0.791 (0.262) [-3.017]

**Table A3.** *Cont.*

	Italy		Spain		
grNCIT <sub>t</sub> (-4)	0.021 (0.013) [1.562]	-0.048 (0.132) [-0.360]	grNCSP <sub>t</sub> (-3)	-0.014 (0.009) [-1.375]	-0.474 (0.254) [-1.865]
grNCIT <sub>t</sub> (-5)	-0.007 (0.014) [-0.512]	0.468 (0.133) [3.506]	grNCSP <sub>t</sub> (-4)	-0.018 (0.008) [-2.295]	0.615 (0.203) [3.022]
grNCIT <sub>t</sub> (-6)	-0.017 (0.016) [-1.034]	0.238 (0.159) [1.499]	grNCSP <sub>t</sub> (-5)	-0.001 (0.011) [-0.097]	0.026 (0.288) [0.091]
grNCIT <sub>t</sub> (-7)	-0.037 (0.015) [-2.551]	0.157 (0.144) [1.089]	grNCSP <sub>t</sub> (-6)	-0.013 (0.011) [-1.179]	-0.162 (0.283) [-0.574]
C	2.916 (1.081) [2.699]	-16.069 (10.673) [-1.506]	grNCSP <sub>t</sub> (-7)	-0.013 (0.010) [-1.215]	-0.832 (0.242) [-4.482]
R sq.	0.836	0.485	grNCSP <sub>t</sub> (-8)	-0.009 (0.009)	-1.085 (0.242)
Obs.	57		C	6.411 (3.309) [1.937]	121.878 (85.548) [1.425]
			R sq.	0.770	0.828
			Obs.	29	

Source: compiled by the authors. Note: R sq. = R squared; Obs. = Observations; standard errors in (); t statistics in []; for variable abbreviations, see Table 1.

**Appendix D**

**Table A4.** VAR Lag Order Selection Criteria (Period 1).

Lag	LogL	LR	FPE	AIC	SC	HQ
lnFTSEMIB40 <sub>t</sub>						
0	76.036	NA	0.002	-2.644	-2.433	-2.473
1	119.238	81.776	6.01 × 10 <sup>-5</sup>	-4.044	-3.088*	-3.209
2	125.726	11.818	5.50 × 10 <sup>-5</sup>	-4.133	-2.962	-3.165
3	131.014	9.253	5.26 × 10 <sup>-5</sup> *	-4.179	-2.947	-3.231
4	134.699	6.185	5.34 × 10 <sup>-5</sup>	-4.168	-2.723	-3.088
5	143.207	13.674	4.57 × 10 <sup>-5</sup>	-4.323	-2.553	-2.998 *
6	146.601	5.212	4.70 × 10 <sup>-5</sup>	-4.307	-2.411	-2.937
7	153.555	10.182*	4.27 × 10 <sup>-5</sup> *	-4.413 *	-2.313	-2.921
8	156.111	3.561	4.55 × 10 <sup>-5</sup>	-4.361	-2.151	-2.840
lnIBEX35 <sub>t</sub>						
0	70.004	NA	0.000	-2.230	-2.160	-2.203
1	112.249	80.334	0.000	-3.484	-3.276	-3.402
2	114.617	4.348	0.000	-3.430	-3.084	-3.294
3	115.540	1.634	0.000	-3.330	-2.845	-3.139
4	124.225	14.807	0.000	-3.483	-2.860	-3.239
5	138.163	22.849	7.66 × 10 <sup>-5</sup>	-3.809	-3.047	-3.510
6	144.061	4.696	7.97 × 10 <sup>-5</sup>	-3.775	-2.876	-3.423
7	144.061	4.395	8.31 × 10 <sup>-5</sup>	-3.750	-2.702	-3.333
8	146.013	2.816 *	8.98 × 10 <sup>-5</sup> *	-3.673 *	-2.450 *	-3.211 *

Source: compiled by the authors. \* lag orders selected by the criterion. Note: LR = sequential modified LR test statistic (at 5% level); FPE = Final predictor error; AIC = Aikake information criterion; SC = Schwarz information criterion; HQ = Hannan-Quinn information criterion; for variable abbreviations, see Table 1.



Appendix E

Table A5. Results of VAR Estimation for FTSE MIB 40 and IBEX 35 (Period 2).

Italy			Spain		
lnFTSEMIB40 <sub>t</sub> (-1)	lnFTSEMIB40 <sub>t</sub> 0.830 (0.124) [6.696]	grNCIT <sub>t</sub> 5.557 (6.605) [0.841]	lnIBEX35 <sub>t</sub> (-1)	lnIBEX35 <sub>t</sub> 0.835 (0.134) [6.243]	grNCSPI <sub>t</sub> -4.697 (4.158) [-1.129]
lnFTSEMIB40 <sub>t</sub> (-2)	0.068 (0.163) [0.414]	-2.417 (8.695) [-0.278]	lnIBEX35 <sub>t</sub> (-2)	0.157 (0.174) [0.901]	6.330 (5.413) [1.169]
lnFTSEMIB40 <sub>t</sub> (-3)	-0.192 (0.116) [-1.656]	-1.521 (6.181) [-0.246]	lnIBEX35 <sub>t</sub> (-3)	-0.203 (0.174) [-1.166]	1.537 (5.424) [0.283]
grNCIT <sub>t</sub> (-1)	0.001 (0.002) [0.359]	-0.192 (0.126) [-1.526]	lnIBEX35 <sub>t</sub> (-4)	-0.045 (0.179) [-0.248]	-3.055 (5.591) [-0.546]
grNCIT <sub>t</sub> (-2)	-8.01 × 10 <sup>-5</sup> (0.003) [-0.036]	-0.324 (0.118) [-2.744]	lnIBEX35 <sub>t</sub> (-5)	0.096 (0.132) [0.724]	-0.347 (4.107) [-0.085]
grNCIT <sub>t</sub> (-3)	0.005 (0.002) [2.403]	-0.346 (0.121) [-2.839]	grNCSPI <sub>t</sub> (-1)	-0.002 (0.004) [-0.637]	-0.347 (0.111) [-2.840]
C	2.912 (0.861) [3.381]	-15.850 (45.895) [-0.345]	grNCSPI <sub>t</sub> (-2)	-0.001 (0.004) [-0.349]	-0.153 (0.119) [-1.279]
R sq.	0.638	0.224	grNCSPI <sub>t</sub> (-3)	-0.003 (0.004)	-0.121 (0.120)
Obs.	64		grNCSPI <sub>t</sub> (-4)	[-0.901] -0.006 (0.004)	[-1.006] -0.126 (0.115)
			grNCSPI <sub>t</sub> (-5)	[-1.693] -0.006 (0.003)	[-1.099] 0.572 (0.108)
			C	[-1.612] 1.429 (0.708) [2.018]	[5.315] 2.361 (22.020) [0.107]
			R sq.	0.772	0.602
			Obs.	65	

Source: compiled by the authors. Note: R sq. = R squared; Obs. = Observations; standard errors in (); t statistics in []; for variable abbreviations, see Table 1.

Appendix F

Table A6. VAR Lag Order Selection Criteria (Period 2).

Lag	LogL	LR	FPE	AIC	SC	HQ
lnFTSEMIB40 <sub>t</sub>						
0	83.248	NA	0.000	-2.500	-2.433	-2.473
1	112.868	56.506	0.000	-3.288	-3.088	-3.209
2	117.136	7.880	0.000	-3.296	-2.962*	-3.165
3	125.014	14.059*	0.000*	-3.416*	-2.947	-3.231*
4	126.070	1.821	0.000	-3.325	-2.723	-3.088
5	128.884	4.674	0.000	-3.289	-2.553	-2.998
6	132.616	5.972	0.000	-3.280	-2.411	-2.937
7	137.795	7.968	0.000	-3.317	-2.313	-2.921
8	140.882	4.560	0.000	-3.289	-2.151	-2.840
lnIBEX35 <sub>t</sub>						
0	70.004	NA	0.000	-2.230	-2.160	-2.203
1	112.249	80.334	0.000	-3.484	-3.276	-3.402
2	114.617	4.348	0.000	-3.430	-3.084*	-3.294
3	115.540	1.634	0.000	-3.330	-2.845	-3.139
4	124.225	14.807	0.000	-3.483	-2.860	-3.239
5	138.163	22.849*	7.66 × 10 <sup>-5</sup> *	-3.809*	-3.047	-3.510*
6	144.061	4.696	7.97 × 10 <sup>-5</sup>	-3.775	-2.876	-3.423
7	144.061	4.395	8.31 × 10 <sup>-5</sup>	-3.750	-2.702	-3.333
8	146.013	2.816	8.98 × 10 <sup>-5</sup>	-3.673	-2.450	-3.211

Source: compiled by the authors. \* lag orders selected by the criterion. Note: LR = sequential modified LR test statistic (at 5% level); FPE = Final predictor error; AIC = Aikake information criterion; SC = Schwarz information criterion; HQ = Hannan–Quinn information criterion; for variable abbreviations, see Table 1.

Appendix G

Table A7. Results of VAR Estimation for FTSE MIB 40 and IBEX 35 (Period 3).

	Italy			Spain		
lnFTSEMIB40 <sub>t</sub> (-1)	lnFTSEMIB40 <sub>t</sub>	grNCIT <sub>t</sub>	lnIBEX35 <sub>t</sub> (-1)	lnIBEX35 <sub>t</sub>	grNCSP <sub>t</sub>	
	0.972 (0.146) [6.643]	1.098 (1.152) [0.953]		1.033 (0.218) [4.735]	-2.594 (2.879) [-0.901]	
lnFTSEMIB40 <sub>t</sub> (-2)	0.281 (0.205) [1.364]	-2.248 (1.620) [-1.387]	lnIBEX35 <sub>t</sub> (-2)	0.267 (0.335) [0.678]	2.345 (4.419) [0.531]	
lnFTSEMIB40 <sub>t</sub> (-3)	-0.321 (0.202) [-1.592]	2.459 (1.589) [1.548]	lnIBEX35 <sub>t</sub> (-3)	-0.628 (0.326) [-1.929]	-1.895 (4.299) [-0.441]	
lnFTSEMIB40 <sub>t</sub> (-4)	0.043 (0.201) [0.211]	-2.045 (1.585) [-1.290]	lnIBEX35 <sub>t</sub> (-4)	0.405 (0.328) [1.235]	4.045 (4.328) [0.935]	
lnFTSEMIB40 <sub>t</sub> (-5)	-0.066 (0.147) [-0.446]	0.182 (1.157) [0.158]	lnIBEX35 <sub>t</sub> (-5)	-0.159 (0.328) [-0.743]	-3.893 (2.819) [-1.381]	
grNCIT <sub>t</sub> (-1)	-0.023 (0.013) [-1.862]	-0.098 (0.098) [-0.991]	grNCSP <sub>t</sub> (-1)	-0.016 (0.009) [-1.853]	-0.429 (0.117) [-3.659]	
grNCIT <sub>t</sub> (-2)	-0.013 (0.013) [-1.013]	0.007 (0.102) [0.071]	grNCSP <sub>t</sub> (-2)	-0.019 (0.009) [-2.074]	-0.376 (0.119) [-3.144]	
grNCIT <sub>t</sub> (-3)	-0.0001 (0.013) [-0.016]	-0.107 (0.098) [-1.091]	grNCSP <sub>t</sub> (-3)	-0.019 (0.009) [-2.065]	-0.343 (0.127) [-2.963]	
grNCIT <sub>t</sub> (-4)	-0.009 (0.011) [-0.791]	0.002 (0.092) [0.021]	grNCSP <sub>t</sub> (-4)	-0.021 (0.009) [-2.213]	-0.399 (0.125) [-3.205]	
grNCIT <sub>t</sub> (-5)	-0.021 (0.011) [-1.835]	0.775 (0.089) [8.679]	grNCSP <sub>t</sub> (-5)	-0.015 (0.009) [-1.679]	0.545 (0.119) [4.543]	
C	0.909 (0.527) [1.726]	5.491 (4.146) [1.325]	C	1.102 (0.535) [2.061]	18.035 (7.057) [2.555]	
R sq.	0.939	0.702	R sq.	0.947	0.899	
Obs.	62		Obs.	48		

Source: compiled by the authors. Note: R sq. = R squared; Obs. = Observations; standard errors in (); t statistics in []; for variable abbreviations, see Table 1.

Appendix H

Table A8. VAR Lag Order Selection Criteria (Period 3).

Lag	LogL	LR	FPE	AIC	SC	HQ
lnFTSEMIB40 <sub>t</sub>						
0	104.440	NA	0.000	-3.304	-3.236	-3.278
1	188.761	160.482	9.43 × 10 <sup>-6</sup>	-5.896	-5.690	-5.815
2	191.063	4.234	9.97 × 10 <sup>-6</sup>	-5.841	-5.498	-5.706
3	197.099	10.709	9.35 × 10 <sup>-6</sup>	-5.906	-5.426	-5.718
4	201.244	7.086	9.33 × 10 <sup>-6</sup>	-5.911	-5.294	-5.669
5	229.531	46.537 *	4.28 × 10 <sup>-6</sup>	-5.695	-5.940 *	-6.398 *
6	233.887	6.885	4.25 × 10 <sup>-6</sup> *	-6.706 *	-5.814	-6.356
7	235.135	1.892	4.67 × 10 <sup>-6</sup>	-6.617	-5.588	-6.213
8	241.062	8.605	4.43 × 10 <sup>-6</sup>	-6.679	-5.513	-6.221
lnIBEX35 <sub>t</sub>						
0	13.991	NA	0.001	-0.571	-0.488	-0.541
1	71.091	160.043	0.000	-3.100	-2.851	-3.009
2	73.637	4.485	0.000	-3.030	-2.617	-2.879
3	75.626	3.315	0.000	-52.935	-2.355	-2.722
4	107.138	49.519	4.98 × 10 <sup>-5</sup>	-4.245	-3.500	-3.972
5	122.094	22.078 *	2.99 × 10 <sup>-5</sup> *	-4.766 *	-3.856 *	-4.433 *
6	123.902	2.497	3.38 × 10 <sup>-5</sup>	-4.662	-3.586	-4.268
7	125.783	2.418	3.83 × 10 <sup>-5</sup>	-4.561	-3.320	-4.106
8	127.012	1.463	4.51 × 10 <sup>-5</sup>	-4.429	-3.022	-3.914

Source: compiled by the authors. \* lag orders selected by the criterion. Note: LR = sequential modified LR test statistic (at 5% level); FPE = Final predictor error; AIC = Aikake information criterion; SC = Schwarz information criterion; HQ = Hannan–Quinn information criterion; for variable abbreviations, see Table 1.

## Appendix I

**Table A9.** Results of Regression Analysis for FTSE MIB 40 and IBEX 35 (Whole Period—1 March 2020–30 November 2020).

	Coefficient	Std. Error	t-Value	p-Stat	R sq.	Observ.
<i>Ordinary least squares regression models</i>						
<b>RetFTSEMIB40<sub>t</sub></b>						
C	0.013	0.005	2.424	0.016 *		
NCIT <sub>t</sub>	$1.66 \times 10^{-7}$	$1.82 \times 10^{-7}$	0.911	0.363		
VIX <sub>t</sub>	-0.0004	0.0002	-2.855	0.005 **	0.049	189
<b>RetIBEX35<sub>t</sub></b>						
C	0.0146	0.005	2.756	0.006 **		
NCSP <sub>t</sub>	$8.98 \times 10^{-8}$	$1.82 \times 10^{-7}$	0.494	0.622		
VIX <sub>t</sub>	-0.0004	0.0002	-2.963	0.004 **	0.046	189
<i>Heteroscedasticity-corrected models</i>						
<b>RetFTSEMIB40<sub>t</sub></b>						
C	0.013	0.011	1.226	0.222		
NCIT <sub>t</sub>	$1.66 \times 10^{-7}$	$1.29 \times 10^{-7}$	1.284	0.201		
VIX <sub>t</sub>	-0.0004	0.0004	-1.167	0.244	0.049	189
<b>RetIBEX35<sub>t</sub></b>						
C	0.0145	0.011	1.396	0.173		
NCSP <sub>t</sub>	$8.98 \times 10^{-7}$	$1.05 \times 10^{-7}$	0.858	0.392		
VIX <sub>t</sub>	-0.0004	0.0004	-1.208	0.229	0.046	189

Source: compiled by the authors. \*\* 99% c.l., \* 95% c.l. Note: Std. Error—Standard Error; p-Stat = p-Statistics; R sq. = R squared; Observ. = Observations; for variable abbreviations, see Table 1.

## Appendix J

**Table A10.** Linear Regression Models for FTSE MIB 40 and IBEX 35 (Period 1—1 March 2020–29 May 2020).

	Coefficient	Std. Error	t-Value	p-Stat	R sq.	Observ.
<i>Ordinary least squares regression models</i>						
<b>RetFTSEMIB40<sub>t</sub></b>						
C	0.045	0.014	3.097	0.003 **		
NCIT <sub>t</sub>	$1.22 \times 10^{-3}$	$3.86 \times 10^{-6}$	3.169	0.002 **		
VIX <sub>t</sub>	-0.002	0.0004	-3.872	0.000 **	0.198	64
<b>RetIBEX35<sub>t</sub></b>						
C	0.026	0.013	2.014	0.048 *		
NCSP <sub>t</sub>	$8.44 \times 10^{-7}$	$2.51 \times 10^{-6}$	0.560	0.577		
VIX <sub>t</sub>	-0.001	0.0003	-2.301	0.025 *	0.082	64
<i>Heteroscedasticity-corrected models</i>						
<b>RetFTSEMIB40<sub>t</sub></b>						
C	0.045	0.021	2.166	0.034 *		
NCIT <sub>t</sub>	$1.22 \times 10^{-5}$	$5.24 \times 10^{-6}$	2.333	0.023 *		
VIX <sub>t</sub>	-0.002	0.001	-2.262	0.027 *	0.198	64
<b>RetIBEX35<sub>t</sub></b>						
C	0.027	0.016	1.663	0.101		
NCSP <sub>t</sub>	$8.44 \times 10^{-7}$	$8.71 \times 10^{-7}$	0.696	0.337		
VIX <sub>t</sub>	-0.001	0.0004	-1.514	0.135	0.082	64

Source: compiled by the authors. \*\* 99% c.l., \* 95% c.l. Note: Std. Error—Standard Error; p-Stat = p-Statistics; R sq. = R squared; Observ. = Observations; for variable abbreviations, see Table 1.

## Appendix K

**Table A11.** Linear Regression Models for FTSE MIB 40 and IBEX 35 (Period 2—1 June 2020–31 August 2020).

	Coefficient	Std. Error	t-Value	p-Stat	R sq.	Observ.
<i>Ordinary least squares regression models</i>						
<b>RetFTSEMIB40<sub>t</sub></b>						
C	0.023	0.013	1.839	0.071		
NCIT <sub>t</sub>	$-8.52 \times 10^{-6}$	$5.24 \times 10^{-6}$	-1.625	0.109		
VIX <sub>t</sub>	-0.001	0.0004	-1.681	0.097	0.063	65
<b>RetIBEX35<sub>t</sub></b>						
C	0.015	0.012	1.207	0.232		
NCSP <sub>t</sub>	$-2.22 \times 10^{-7}$	$4.70 \times 10^{-7}$	-0.472	0.638		
VIX <sub>t</sub>	-0.001	0.004	-1.323	0.194	0.030	65
<i>Heteroscedasticity-corrected models</i>						
<b>RetFTSEMIB40<sub>t</sub></b>						
C	0.023	0.014	1.616	0.111		
NCIT <sub>t</sub>	$-8.52 \times 10^{-6}$	$4.03 \times 10^{-6}$	-2.115	0.039 *		
VIX <sub>t</sub>	-0.001	0.001	-1.413	0.163	0.063	65
<b>RetIBEX35<sub>t</sub></b>						
C	0.015	0.014	1.093	0.279		
NCSP <sub>t</sub>	$-2.22 \times 10^{-7}$	$3.49 \times 10^{-7}$	-0.636	0.527		
VIX <sub>t</sub>	-0.001	0.001	-1.141	0.258	0.030	65

Source: compiled by the authors. \* 95% c.l. Note: Std. Error—Standard Error; p-Stat = p-Statistics; R sq. = R squared; Observ. = Observations; for variable abbreviations, see Table 1.

## Appendix L

**Table A12.** Linear Regression Models for FTSE MIB 40 and IBEX 35 (Period 3—1 September 2020– 30 November 2020).

	Coefficient	Std. Error	t-Value	p-Stat	R sq.	Observ.
<i>Ordinary least squares regression models</i>						
<b>RetFTSEMIB40<sub>t</sub></b>						
C	0.013	0.014	0.964	0.339		
NCIT <sub>t</sub>	$2.33 \times 10^{-7}$	$1.47 \times 10^{-7}$	1.588	0.118		
VIX <sub>t</sub>	-0.001	0.0004	-1.129	0.264	0.068	60
<b>RetIBEX35<sub>t</sub></b>						
C	0.020	0.015	1.380	0.173		
NCSP <sub>t</sub>	$1.01 \times 10^{-7}$	$1.32 \times 10^{-7}$	0.768	0.446		
VIX <sub>t</sub>	-0.001	0.001	-1.238	0.221	0.036	60
<i>Heteroscedasticity-corrected models</i>						
<b>RetFTSEMIB40<sub>t</sub></b>						
C	0.013	0.023	0.571	0.570		
NCIT <sub>t</sub>	$2.33 \times 10^{-7}$	$1.50 \times 10^{-7}$	1.555	0.126		
VIX <sub>t</sub>	-0.001	0.001	-0.652	0.517	0.068	60
<b>RetIBEX35<sub>t</sub></b>						
C	0.020	0.018	1.131	0.263		
NCSP <sub>t</sub>	$1.01 \times 10^{-7}$	$1.29 \times 10^{-7}$	0.785	0.436		
VIX <sub>t</sub>	-0.001	0.001	-0.980	0.331	0.036	60

Source: compiled by the authors. Note: Std. Error—Standard Error; p-Stat = p-Statistics; R sq. = R squared; Observ. = Observations; for variable abbreviations, see Table 1.

## Appendix M

Table A13. Results of Heteroskedasticity Test: ARCH Effects for Return of Selected Indexes.

Dependent Variable		Whole Period			
RetFTSEMIB40 <sub>t</sub>	F-statistic	5.231	Prob. F(1,183)	0.023 *	
	Obs*R-squares	5.141	Prob. Chi-Square(1)	0.023 *	
RetIBEX35 <sub>t</sub>	F-statistic	5.102	Prob. F(1,183)	0.025 *	
	Obs*R-squares	5.018	Prob. Chi-Square(1)	0.025 *	
<b>Period 1</b>					
RetFTSEMIB40 <sub>t</sub>	F-statistic	3.048	Prob. F(1,61)	0.086	
	Obs*R-squares	2.998	Prob. Chi-Square(1)	0.083	
RetIBEX35 <sub>t</sub>	F-statistic	0.405	Prob. F(1,61)	0.527	
	Obs*R-squares	0.416	Prob. Chi-Square(1)	0.591	
<b>Period 2</b>					
RetFTSEMIB40 <sub>t</sub>	F-statistic	0.098	Prob. F(1,55)	0.755	
	Obs*R-squares	0.102	Prob. Chi-Square(1)	0.749	
RetIBEX35 <sub>t</sub>	F-statistic	1.853	Prob. F(1,62)	0.220	
	Obs*R-squares	1.857	Prob. Chi-Square(1)	0.214	
<b>Period 3</b>					
RetFTSEMIB40 <sub>t</sub>	F-statistic	0.121	Prob. F(1,59)	0.729	
	Obs*R-squares	0.125	Prob. Chi-Square(1)	0.724	
RetIBEX35 <sub>t</sub>	F-statistic	1.254	Prob. F(1,55)	0.267	
	Obs*R-squares	0.007	Prob. Chi-Square(1)	0.935	

Source: compiled by the authors. \* 95% c.l. Note: Std. Error—Standard Error; p-Stat = p-Statistics; R sq. = R squared; Observ. = Observations; for variable abbreviations, see Table 1.

## References

- Ahmar, Ansari Saleh, and Eva Boj del Val. 2020. SutteARIMA: Short-term forecasting method, a case: Covid-19 and stock market in Spain. *Science of The Total Environment* 729: 138883. [CrossRef] [PubMed]
- Ahundjanov, Behzod B., Sherzod B. Akhundjanov, and Botir B. Okhunjanov. 2020. Information Search and Financial Markets under COVID-19. *Entropy* 22: 791. [CrossRef] [PubMed]
- Al-Awadhi, Abdullah, Khaled Alsaifi, Ahmad Al-Awadhi, and Salah Alhammedi. 2020. Death and contagious infectious diseases: Impact of the COVID-19 virus on stock market returns. *Journal of Behavioral and Experimental Finance* 27: 100326. [CrossRef] [PubMed]
- Albulescu, Claudiu. 2020. Coronavirus and Financial Volatility: 40 Days of Fasting and Fear. *SSRN Electronic Journal*. [CrossRef]
- Ashraf, Badar Nadeem. 2020. Stock markets' reaction to covid-19: Cases or fatalities? *Research in International Business and Finance* 54: 6–10. [CrossRef] [PubMed]
- AvaTrade. 2021. Ftse mib 40 Trading: Why Trade FTSE CFD? July 6. Available online: <https://www.avatrade.co.uk/trading-info/financial-instruments-index/indices/ftsemib> (accessed on 15 July 2021).
- Baek, Seunggho, Sunil K. Mohanty, and Mina Glamboosky. 2020. COVID-19 and stock market volatility: An industry level analysis. *Finance Research Letters* 37: 341. [CrossRef]
- Beirne, John, Renzhi Nuobu, Eric Sugandi, and Ulrich Volz. 2020. Financial Market and Capital Flow Dynamics During the COVID-19 Pandemic. ABDI Working Papers 1158. Available online: <https://www.adb.org/sites/default/files/publication/616806/adbi-wp1158.pdf> (accessed on 27 September 2021).
- Ben Haddad, Hedi, Imed Mezghani, and Abdesslem Gouider. 2021. The Dynamic Spillover Effects of Macroeconomic and Financial Uncertainty on Commodity Markets Uncertainties. *Economics* 9: 91. [CrossRef]
- Bonaccolto, Giovanni, Nicola Borri, and Andrea Consiglio. 2019. Breakup and default risks in the eurozone. *SSRN Electronic Journal*, 14–32. [CrossRef]
- Borri, Nicola. 2020. The COVID-19 challenge to European financial markets. lessons from Italy. *SSRN Electronic Journal*: 137–47. [CrossRef]
- Brueckner, Markus, and Joaquin Vespignani. 2020. COVID-19 Infections and the Performance of the Stock Market: An Empirical Analysis for Australia. *SSRN Electronic Journal*. [CrossRef]
- Camarero, Jose. 2020. El Ibex se desploma un 14%, la mayor caída de su historia en un solo día. Available online: <https://www.elcomercio.es/economia/mercados/ibex-afrenta-jornada-20200312090857> (accessed on 18 February 2021).

- Chaudhary, Rashmi, Priti Bakhshi, and Hemendra Gupta. 2020. Volatility in International Stock Markets: An Empirical Study during COVID-19. *Journal of Risk and Financial Management* 13: 208. [CrossRef]
- Cheong, Calvin W., Mohamed Ariff, and Niviethan Rao Subramaniam. 2020. Did financial markets overreact to covid-19? *SSRN Electronic Journal*, 3–8. [CrossRef]
- Chikri Hassan, Adil Moghar, Manar Kassou, Faruk Hamza, and Salmane Bouekkadi. 2020. The Asymmetric Influence of COVID-19 on Financial Market: Evidence from NARDL Model. *Education Excellence and Innovation Management: A 2025 Vision to Sustain Economic Development during Global Challenges*. pp. 15657–73. Available online: <https://pesquisa.bvsalud.org/global-literature-on-novel-coronavirus-2019-ncov/resource/pt/covidwho-1329377> (accessed on 15 July 2021).
- Ciner, Cetin. 2021. Stock return predictability in the time of COVID-19. *Finance Research Letters* 38: 2–4. [CrossRef] [PubMed]
- Czech, Katarzyna, Michal Wielechowski, Pavel Kotyza, Irena Benešová, and Adriana Laputková. 2020. Shaking stability: COVID-19 impact on the Visegrad Group countries' financial markets. *Sustainability* 12: 6282. [CrossRef]
- Davies, Guy. 2020. Italy and Spain Begin to Reopen after coronavirus Lockdown, Rest of Europe to Follow Suit. *ABC News*, May 18. Available online: <https://abcnews.go.com/International/italy-spain-begin-reopen-coronavirus-lockdown-rest-europe/story?id=70742735> (accessed on 15 June 2021).
- Dias, Rui, Paula Heliodoro, and Paulo Alexandre. 2020. The impact of COVID-19 on European financial markets: An empirical analysis. In *Proceedings of 6th International Scientific-Business Conference of Leadership, Innovation, Management and Economics: Integrated Politics of Research*. Belgrade: Association of Economists and Managers of the Balkans. [CrossRef]
- Duttilo, Pierdomenico, Stefano Antonio Gattone, and Tonio Di Battista. 2021. Volatility Modeling: An Overview of Equity Markets in the Euro Area during COVID-19 Pandemic. *Mathematics* 9: 1212. [CrossRef]
- Endri, Endri, Widya Aipama, A. Razak, Laynita Sari, and Renil Septiano. 2020. Stock price volatility during the COVID-19 pandemic: The GARCH model. *Investment Management and Financial Innovations* 18: 12–20. [CrossRef]
- Fassas, Athanasios P. 2020. Risk aversion connectedness in developed and emerging equity markets before and after the COVID-19 pandemic. *Heliyon* 6: e05715.3-6. [CrossRef]
- Frezza, Massimiliano, Sergio Bianchi, and Augusto Pianese. 2020. Fractal analysis of market (in)efficiency during the COVID-19. *Finance Research Letters* 38: 3. [CrossRef]
- Ftiti, Zied, Hachmi Ben Ameur, and Wael Louhichi. 2021. Does non-fundamental news related to COVID-19 matter for stock returns? Evidence from Shanghai stock market. *Economic Modelling* 99: 105484. [CrossRef]
- Gherghina, Ștefan Cristian, Daniel Ștefan Armeanu, and Camelia Catalina Joldeș. 2021. COVID-19 Pandemic and Romanian Stock Market Volatility: A GARCH Approach. *Journal of Risk and Financial Management* 14: 341. [CrossRef]
- Gormsen, Niels Joachim, and Ralf S.J. Koijen. 2020. *Coronavirus: Impact on Stock Prices and Growth Expectations*. Working Paper No. 2020-22. Chicago: University of Chicago, Becker Friedman Institute for Economics. [CrossRef]
- Grima, Simon, Letife Özdemir, Ercan Özen, and Inna Romānova. 2021. The Interactions between COVID-19 Cases in the USA, the VIX Index and Major Stock Markets. *International Journal of Financial Studies* 9: 26. [CrossRef]
- He, Qing, Junyi Liu, Sizhu Wang, and Jishuang Yu. 2020. The impact of COVID-19 on stock markets. *Economic and Political Studies* 8: 275–88. [CrossRef]
- Henriquez, Josefa, Eduardo Gonzalo Almorox, Manuel Garcia-Goñi, and Francesco Paolucci. 2020. The first months of the COVID-19 pandemic in Spain. *SSRN Electronic Journal*, 10–14. [CrossRef]
- Huynh, Toan, Matteo Foglia, Muhammad Ali Nasir, and Eliana Angelini. 2021. Feverish sentiment and global equity markets during the COVID-19 pandemic. *Journal of Economic Behavior & Organization* 188: 1088–108. [CrossRef]
- Ians. 2021. Italy's COVID-19 Indicators Improve Amid Govt's Review of Policies. *Business Standard*. Available online: [https://www.business-standard.com/article/current-affairs/italy-s-covid-19-indicators-improve-amid-govt-s-review-of-policies-121021900312\\_1.html](https://www.business-standard.com/article/current-affairs/italy-s-covid-19-indicators-improve-amid-govt-s-review-of-policies-121021900312_1.html) (accessed on 30 June 2021).
- Ibrahim, Izani, Kamilah Kamaludin, and Sheela Sundarasan. 2020. COVID-19, Government Response, and Market Volatility: Evidence from the Asia-Pacific Developed and Developing Markets. *Economics* 8: 105. [CrossRef]
- Instituto Nacional de Estadística. 2020. Tourist Satellite Account of Spain. Available online: [https://www.ine.es/dyngs/INEbase/en/operacion.htm?c=estadistica\\_C&cid=1254736169169&menu=ultiDatos&idp=1254735576863](https://www.ine.es/dyngs/INEbase/en/operacion.htm?c=estadistica_C&cid=1254736169169&menu=ultiDatos&idp=1254735576863) (accessed on 12 May 2021).
- Izzeldin, Marwan, Yaz Gulnur Muradoğlu, Vasileios Pappas, and Sheeja Sivaprasad. 2021. The impact of covid-19 on G7 stock markets volatility: Evidence from a ST-HAR model. *International Review of Financial Analysis* 74: 3–6. [CrossRef]
- Kanapickiene, Rasa, Deimante Teresiene, Daiva Budriene, Greta Keliuotyte-Staniuleniene, and Jekaterina Kartasova. 2020. The impact of COVID-19 on European Financial Markets and Economic Sentiment. *Journal of International Scientific Publications, Economy & Business* 14: 144–63.
- Klose, Jens, and Peter Tillmann. 2021. COVID-19 and Financial Markets: A Panel analysis for European countries. *Jahrbücher Für Nationalökonomie Und Statistik* 241: 10–16. [CrossRef]
- Lee, Hee Soo. 2020. Exploring the initial impact of COVID-19 sentiment on US stock market using big data. *Sustainability* 12: 6648. [CrossRef]
- Milani, Fabio. 2021. COVID-19 Outbreak, Social Response, and Early Economic Effects: A Global VAR Analysis of Cross-Country Interdependencies. *Journal of Population Economics* 34: 222–52. [CrossRef]

- Moran, Matthew T., and Belinda Liu. 2020. The VIX Index and Volatility Based Global Indexes and Trading Instruments. A Guide to Investment and Trading Futures. CFA Institute Research Foundation. April. Available online: <https://www.spglobal.com/spdji/en/documents/research/research-the-vix-index-and-volatility-based-global-indexes-and-trading-instruments.pdf> (accessed on 15 October 2021).
- Mzoughi, Hela, Urom Christian, Uddin Gazi Salah, and Guesmi Khaled. 2020. The Effects of COVID-19 Pandemic on Oil Prices, CO<sub>2</sub> Emissions and the Stock Market: Evidence from a VAR Model. *SSRN Electronic Journal*, 3587906. [CrossRef]
- Nieto, Belen, and Gonzalo Rubio. 2020. The Coronavirus Impact on Stock Returns in Spain. pp. 22–28. Available online: [https://www.bolsasymercados.es/ing/Studies-Research/Document/5383\\_The\\_Coronavirus\\_Impact\\_on\\_Stock\\_Returns\\_in\\_Spain\\_](https://www.bolsasymercados.es/ing/Studies-Research/Document/5383_The_Coronavirus_Impact_on_Stock_Returns_in_Spain_) (accessed on 12 July 2021).
- O'Donnell, Niall, Darren Shannon, and Barry Sheehan. 2021. Immune or AT-RISK? Stock markets and the significance of the COVID-19 pandemic. *Journal of Behavioral and Experimental Finance* 30: 4–9. [CrossRef] [PubMed]
- Panyagometh, Kamphol. 2020. The Effects of Pandemic Event on the Stock Exchange of Thailand. *Economies* 8: 90. [CrossRef]
- Rakha, Ahmed, Hansi Hettiarachchi, Dina Rady, Mohamed Medhat Gaber, Emad Rakha, and Mohammed M. Abdelsamea. 2021. Predicting the Economic Impact of the COVID-19 Pandemic in the United Kingdom Using Time-Series Mining. *Economies* 9: 137. [CrossRef]
- Ramelli, Stefano, and Alexander F. Wagner. 2020. Feverish stock price reactions to COVID-19. *The Review of Corporate Finance Studies* 9: 622–55. [CrossRef]
- Sanfelici, Mara. 2020. The Italian response to the COVID-19 crisis: Lessons learned and future direction in social development. *The International Journal of Community and Social Development* 2: 191–210. [CrossRef]
- Sansa, Nuhu A. 2020. The impact of the covid-19 on the Financial Markets: Evidence from China and USA. *SSRN Electronic Journal*, 30–38. [CrossRef]
- Schoenfeld, Jordan. 2020. The invisible risk: Pandemics and the financial markets. *Covid Economics, Vetted and Real-Time Papers* 6: 119–36. [CrossRef]
- Sen, Sree. 2020. Spain declares a national state of EMERGENCY AMIDST second wave of Covid-19 pandemic. *DNA India*. October 26. Available online: <https://www.dnaindia.com/world/report-spain-nationwide-emergency-corona-virus-pandemic-canary-islands-2852300> (accessed on 16 July 2021).
- Shahzad, Syed, Muhammad Naeem, Zhe Peng, and Elie Bouri. 2021. Asymmetric volatility spillover among Chinese sectors during COVID-19. *International Review of Financial Analysis* 75: 101754. [CrossRef]
- Shankar, Rishika, and Priti Dubey. 2021. Indian Stock Market during the COVID-19 Pandemic: Vulnerable or Resilient? Sectoral analysis. *Organizations and Markets in Emerging Economies* 12: 1. [CrossRef]
- Shehzad, Khurram, Liu Xiaoxing, and Hayfa Kazouz. 2020. COVID-19's disasters are perilous than global financial crisis: A rumor or fact? *Finance Research Letters* 36: 11. [CrossRef] [PubMed]
- S&P Global Report. 2020. Coronavirus: Economic & Credit Market Implications. Available online: <https://www.spglobal.com/en/research-insights/featured/economic-implications-of-coronavirus> (accessed on 16 April 2021).
- Stevens, Pippa, Maggie Fitzgerald, and Fred Imbert. 2020. Stock Market Live THURSDAY: Dow Tanks 2300 in Worst Day Since Black MONDAY, S&P 500 Bear Market. CNBC. Available online: <https://www.cnbc.com/2020/03/12/stock-market-today-live.html> (accessed on 18 June 2021).
- Thakur, Sheeram. 2020. Effect of COVID-19 on Capital Market with Reference To S&P 500. *International Journal of Advanced Research* 8: 1180–88.
- Trading Economics. 2020. Euro Zone, Italy and Spain statistics. Available online: <https://tradingeconomics.com/> (accessed on 10 June 2021).
- Wang, Wenzhao, and Martin Enilov. 2020. The global impact of COVID-19 on financial markets. *SSRN Electronic Journal*, 5–8. [CrossRef]
- Wei, Xiaojun, and Liyan Han. 2021. The impact of COVID-19 pandemic on transmission of monetary policy to financial markets. *International Review of Financial Analysis* 74: 4–9. [CrossRef]
- World Meters. 2021. Italy Coronavirus Statistics. Available online: <https://www.worldometers.info/coronavirus/country/italy/> (accessed on 1 May 2021).
- Xu, Libo. 2021. Stock Return and the COVID-19 Pandemic: Evidence from Canada and the US. *Finance Research Letters* 38: 101872. [CrossRef]
- Yousaf, Imran, Shoaib Ali, and Wing-Keung Wong. 2020. Return and Volatility Transmission between World-Leading and Latin American Stock Markets: Portfolio Implications. *Journal of Risk Financial Management* 13: 148. [CrossRef]
- Zaremba, Adam, Renatas Kizys, David Y. Aharon, and Ender Demir. 2020. Infected Markets: Novel Coronavirus, Government Interventions and Stock Return Volatility around the Globe. *Finance Research Letters* 35: 101597. [CrossRef]
- Zhang, Dayong, Min Hu, and Qiang Ji. 2020. Financial markets under the global pandemic of COVID-19. *Finance Research Letters* 36: 101528. [CrossRef] [PubMed]

## Article

# Early Warning Early Action for the Banking Solvency Risk in the COVID-19 Pandemic Era: A Case Study of Indonesia

Taufiq Hidayat <sup>1,\*</sup>, Dian Masyita <sup>2</sup>, Sulaeman Rahman Nidar <sup>2</sup>, Fauzan Ahmad <sup>3</sup> and Muhammad Adrissa Nur Syarif <sup>3</sup>

<sup>1</sup> STIE Indonesia Banking School, Jakarta 12730, Indonesia

<sup>2</sup> Fakultas Ekonomi dan Bisnis, Universitas Padjadjaran, Bandung 40132, Indonesia; dian.masyita@unpad.ac.id (D.M.); sulaeman.rahman@unpad.ac.id (S.R.N.)

<sup>3</sup> System Dynamics Bandung Bootcamp, Bandung 40534, Indonesia; ojan\_154@yahoo.com (F.A.); adrisansyarif@gmail.com (M.A.N.S.)

\* Correspondence: taufiq.hidayat@ibs.ac.id

**Abstract:** The COVID-19 pandemic has affected people's lives and increased the banking solvency risk. This research aimed to build an early warning and early action simulation model to mitigate the solvency risk using the system dynamics methodology and the Powersim Studio 10© software. The addition of an early action simulation updates the existing early warning model. Through this model, the effect of policy design and options on potential solvency risks is known before implementation. The trials conducted at Bank BRI (BBRI) and Bank Mandiri (BMRI) showed that the model had the ability to provide an early warning of the potential increase in bank solvency risk when the loan restructuring policy is revoked. It also simulates the effectiveness of management's policy options to mitigate these risks. This research used publicly accessible banking data and analysis. Bank management could also take advantage of this model through a self-stimulation facility developed in this study to accommodate their needs using the internal data.

**Keywords:** banking sector; COVID-19 outbreak; corporate insolvency; simulation; loan restructuring policy; system dynamics; early warning early action

**Citation:** Hidayat, Taufiq, Dian Masyita, Sulaeman Rahman Nidar, Fauzan Ahmad, and Muhammad Adrissa Nur Syarif. 2022. Early Warning Early Action for the Banking Solvency Risk in the COVID-19 Pandemic Era: A Case Study of Indonesia. *Economies* 10: 6. <https://doi.org/10.3390/economies10010006>

Academic Editor: Ștefan Cristian Gherghina

Received: 23 November 2021

Accepted: 21 December 2021

Published: 24 December 2021

**Publisher's Note:** MDPI stays neutral with regard to jurisdictional claims in published maps and institutional affiliations.



**Copyright:** © 2021 by the authors. Licensee MDPI, Basel, Switzerland. This article is an open access article distributed under the terms and conditions of the Creative Commons Attribution (CC BY) license (<https://creativecommons.org/licenses/by/4.0/>).

## 1. Introduction

The COVID-19 pandemic has impacted all sectors and the economic activities of people in Indonesia. Almost all economic activities experienced a slowdown, especially businesses supported by loans from banks, including large enterprises and small and medium enterprises (SMEs). Consequently, these conditions have impacted the banking sector, resulting in several risks. These include an increased risk of non-performing loans (Barua and Barua 2021), abundant bank liquidity due to slowing loan demand (Goodell 2020), and a decline in banking profitability (Knowles et al. 2020). Although the economic crisis due to the COVID-19 outbreak is different from previous crises, it has similar consequences, including widespread business bankruptcies, increased unemployment, and worsening banking solvency (Danielsson et al. 2020).

The Financial Services Authority (OJK), as the supervisory authority and regulator of banking in Indonesia, issued a loan restructuring policy for debtors that were affected by the pandemic in March 2020 to reduce the pandemic's impact on solvency risk. The non-performing loan (NPL) restructured based on this regulation can still be categorized as a performing loan, and the bank does not have to set aside any loan impairment expenses. The policy is a quick response to the impact of COVID-19, relaxing the rules for restructuring non-performing loans, and was enforced for the first time. It was extended several times, until 31 March 2023.

The restructuring policy aims to curb the increase in NPL and allow time for banks to strengthen their reserves for impairment losses on loans and capital to avoid the solvency



risk. However, the NPL ratio of banks in Indonesia reached 3.35% in June 2021, the highest level since January 2019. This could still increase if outstanding loans that were restructured with the OJK policy are not entirely repaid. As of 30 June 2021, the proportion of restructured loans to total loans was 17.32% (Bank Indonesia 2021). Siregar et al. (2021) estimated that the NPL potential of the loan restructuring would range from 10 to 30% when the OJK policy is revoked. In these estimations, the national banking industry experiences a potential NPL ratio level above 5% or exceeds the NPL standard set by the regulator. Subsequently, the capital adequacy ratio (CAR) would decline, increasing the bank solvency risk.

In reference to this banking situation, the challenge is to estimate the bank solvency conditions based on each bank's capital capacity and potential NPL risk. Considering the outstanding loan restructures, NPL volume and ratio, the simulation for each bank could be calculated to detect the risk of solvency at an early stage (early warning), and present some early action plans (early action) to prevent the risk (Leaning 2016; Lang et al. 2018). Al-Kharusi and Murthy (2020) and Pavlov and Katsamakos (2021) examined early warning financial risks during the COVID-19 pandemic using a financial statement simulation methodology. However, the research did not model an early action plan to prevent these potential risks. Therefore, this research developed the model's function to not only provide some early warnings but also propose some early actions in one simulation, to prevent the bank solvency risk related to regulation.

The system dynamics methodology was used to model the complex financial transactions to produce financial statement baselines. Additionally, the methodology helps to simulate the feedback effect of the early actions with some changes to the baseline financial statement behavior (Oladimeji et al. 2020). Subsequently, this research produces an early information simulation model of solvency risk per individual bank and preventive policy options for management of the potential risks. The model could practically become a self-simulation tool for early warning and early action regarding solvency risks in bank management.

The research questions of this study are: (1) How to develop the simulation model to provide an early warning of solvency risk in the banking industry in Indonesia during the COVID-19 outbreak; (2) How to simulate early action to mitigate and prevent the solvency risk to respond the revocation of the loan restructuring policy by OJK. Using system dynamic simulation, this research resulted in a model that can deliver early warnings for individual bank solvency risk and early actions for the individual bank management to prevent the solvency risks and increase the readiness for revocation of the loan restructuring policy.

This research makes an important contribution to the study of the early warning system of bank bankruptcy risks for several reasons, namely: (1) the use of system dynamics simulation methods to modelling the complex, dynamic and ongoing bank risk behaviour during the pandemic COVID-19, (2) the research is to be able to produce an effective early warning of the bank solvency risks and (3) the research is a kind of a forward looking oriented simulation to predict the potential bank bankruptcy risks. The added value of this research is the existence of a dynamic bank balance sheet simulation so that the condition of the bank's asset, liabilities, capital and profit and loss during the COVID-19 pandemic and the risk of bank solvency can be detected at any time. By monitoring the condition of bank's loan performance through several main variables related to solvency risk, bank's management can determine appropriate policies to reduce this risk and indirectly reduce the risk of bank's bankruptcy. This research is able to produce simulation models in the form of early warnings and simulations of several policy options as early actions for the bank's management to respond the risk of non-performing loan, solvency risk and bank's bankruptcy due to the COVID-19 pandemic.

The structure of this paper consists of five parts, beginning with the introduction that contains the background of the research. Section 2 discusses the literature review, namely the related literature and previous research, Section 3 explains the research methodology followed by the research results and Section 4 is a discussion of the results of the research.

Lastly is the section of the conclusion and suggestions that also contains the implication of the research results. This study is ended with a reference of the studies that used in the research.

## 2. Literature Review

According to [De Vany \(1984\)](#), the main causes of bank bankruptcy are the information asymmetry, agency problem and moral hazard that occur together. [Smith \(2010\)](#) found evidence that there is a correlation between agency problems and bank bankruptcy in the crisis period of 2007 and 2008. The agency problem is the problem of mismatch of interests between shareholders as principals and management as agents ([Jensen and Meckling 1976](#); [Rose 1992](#)). In the banking sector, agency relationships occur between bank management with shareholders and banking supervisory authorities ([Henrard and Olieslagers 2004](#)) as well as with depositors ([Kuritzkes et al. 2003](#)). Banking supervisory authorities play a role in protecting the interests of depositors by issuing various regulations that must be obeyed by bank management and shareholders ([Donnellan and Rutledge 2016](#)), including the issuance of policies for loan restructuring during the COVID-19 pandemic by the Financial Services Authority, then it is an agency relationship intervention in order to reduce the risk of bank bankruptcy and protect depositors ([Hidayat et al. 2021](#)).

Bank bankruptcy can also arise due to changes in financial conditions both internally and externally of the bank. Bank bankruptcy can also arise from increased loan risk arising from debtor moral hazard, weak analysis of creditworthiness, external conditions such as the decline in the community's economic capacity due to the COVID-19 pandemic or lending to high-risk sectors. Bank management as an agent in the agency theory needs to recognize weak signals in the economic environment that will affect loan risk and bank bankruptcy, such as high NPL levels and declining CAR ratios. A weak signal is a symptom of bank performance that provides the basis for managerial decision making to ensure that the bank's strategy can be achieved. Meanwhile, based on the weak banking signal information, a system is needed to provide some early warnings for bank management to be aware of the potential risks that may arise. early warning systems are a key tool for bank management to anticipate and make policies to reduce the potential risks of bank bankruptcy ([Gunnensen 2014](#)).

Most of the literature research on early warnings of bank solvency risk are backward-oriented. This means that the literature is based on historical financial statements to provide early warning indicators of these potential risks. For instance, [Korzeb and Niedziółka \(2020\)](#); [Barua and Barua \(2021\)](#); [Hardiyanti and Aziz \(2021\)](#) showed the phenomenon of increased NPL risk during the COVID-19 pandemic. The increase in NPL reduced cash flow, profit, and CAR ([Mayes and Stremmel 2012](#); [Donnellan and Rutledge 2016](#)). Consequently, a decrease in CAR increased the bank solvency risk, as measured by Z-Score ([Lepetit et al. 2020](#)). This research used the NPL, CAR, and Z-Score ratios to show the solvency risk.

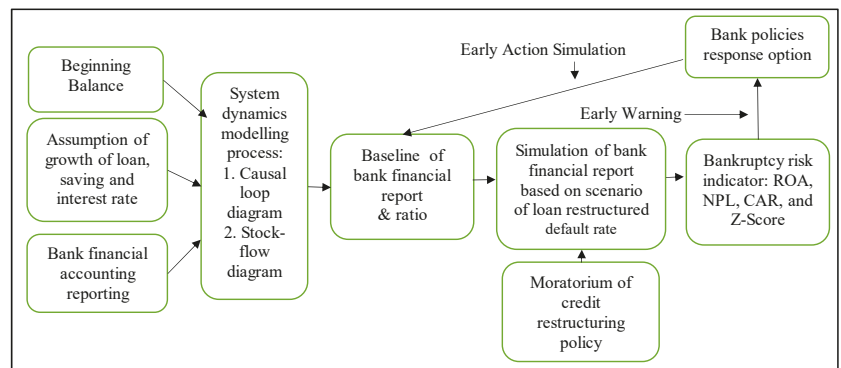
Facing the COVID-19 pandemic requires a forward-looking approach for early warnings of potential bank solvency risks and early action to prevent these risks. For these reasons, the simulation methodology was used to develop baseline projections for financial statements. These baselines describe future financial risk conditions and changes in their behavior due to some unexpected events. Furthermore, the simulation results were used to develop several alternative early action policies to reduce solvency risk ([Pavlov and Katsamakos 2021](#); [Petropoulos et al. 2020](#)). These include the promotion of loan growth, managing restructured loans, increasing bank operational cost efficiency, lowering interest expenses, and increasing loan interest ([Bastana et al. 2016](#); [Samorodov et al. 2019](#); [Rahmi and Sumirat 2021](#)). Those policies are expected to strengthen bank capital to avoid solvency risk. However, the early action policy should be simulated first to determine the feedback on potential changes in the solvency risk levels and the optimum policy options ([Schuermann 2014](#)). According to [Wu \(2014\)](#) and [Kunc et al. \(2018\)](#), the system dynamics methodology is a simulation modeling that accommodates the feedback process in managerial decision making.

System Dynamics is a methodology to design strategies and policies with computer simulation tools (Sapiri et al. 2020), to produce better responses to the complex and dynamic problems in the social, managerial or economic fields (Sterman 2000; Morecroft 2015; Duggan 2016). To solve the complex problems, according to Bala et al. (2017), the structures, and the relationship between the structures in the problem, should be analyzed. The system dynamics model describes the structure of financial statement accounts based on stock, rate, auxiliary, and constant. The pattern of the relationships between the accounts in the financial statements are modeled through causal-loop and stock-flow diagrams (García 2019). The financial statements model of system dynamics was developed in some studies by Islam et al. (2013); Wu (2014); Istiaq (2015); Pierson (2020); Aksu and Tursun (2021); Pavlov and Katsamakos (2021); Hidayat et al. (2021) to analyze financial reporting, banking risk management, management control systems, and solvency stress-testing.

### 3. Methodology

This research used the previous literature to accommodate the bank's needs when dealing with the COVID-19 pandemic and the loan restructuring policy revocation. It aims to develop a simulation model to generate early warnings and identify early actions to mitigate bank solvency risks using Powersim Professional 10© software. Furthermore, it intends to advance the modeling of bank financial statements and several important financial ratios developed by Islam et al. (2013); Pierson (2020) and Hidayat et al. (2021) through causal-loop and stock flow diagrams.

The modeling begins by analyzing the structures of bank financial statements and growth assumptions to produce the baseline financial report, and then could be used as a comparison in further simulations. When the loan restructuring policy ends, the baseline financial report is simulated to obtain the early warning on solvency risk and prepare the policy response. The policy response is simulated first to determine its impact on solvency risk before implementation. The simulation modeling stages for early warning and early action for bank solvency risk are presented in Figure 1.



**Figure 1.** Stages of Early Warning, Early Action Simulation Modeling of Bank Solvency Risk (Schuermann 2014).

The simulation model was applied to BBRI and BMRI, the two largest banks in Indonesia. Data were obtained on the initial balance of financial statements to model from the financial position statement balance as of 31 December 2019 (audited). The simulation modeling period is monthly, from the 1st period (January 2020) to the 48th period (December 2023). An early warning simulation of solvency risk was performed in the 21st period, or September 2021, to determine the early risk condition if the loan restructuring policy revocation is implemented in March 2023 (39th period). After obtaining the early warning information, an early action simulation was performed to determine the

impact of each policy on changes in CAR and Z-Score until the 48th period. The bank is categorized as insolvable if the Z-Score < 0 and/or the CAR ratio less than its threshold based on the standard of each bank. The higher the CAR and Z-Score, the more solvable the bank (Lepetit et al. 2020). The Z-Score formula used was:

$$\text{Z-Score} = ((\text{ROA} + (\text{equity}/\text{total assets}))/\text{ROA standard deviation}) \tag{1}$$

The other financial ratios that become indicators of bank solvency are:

$$\text{Return on asset (ROA)} = \frac{\text{Net Profit}}{\text{Total Asset}} \tag{2}$$

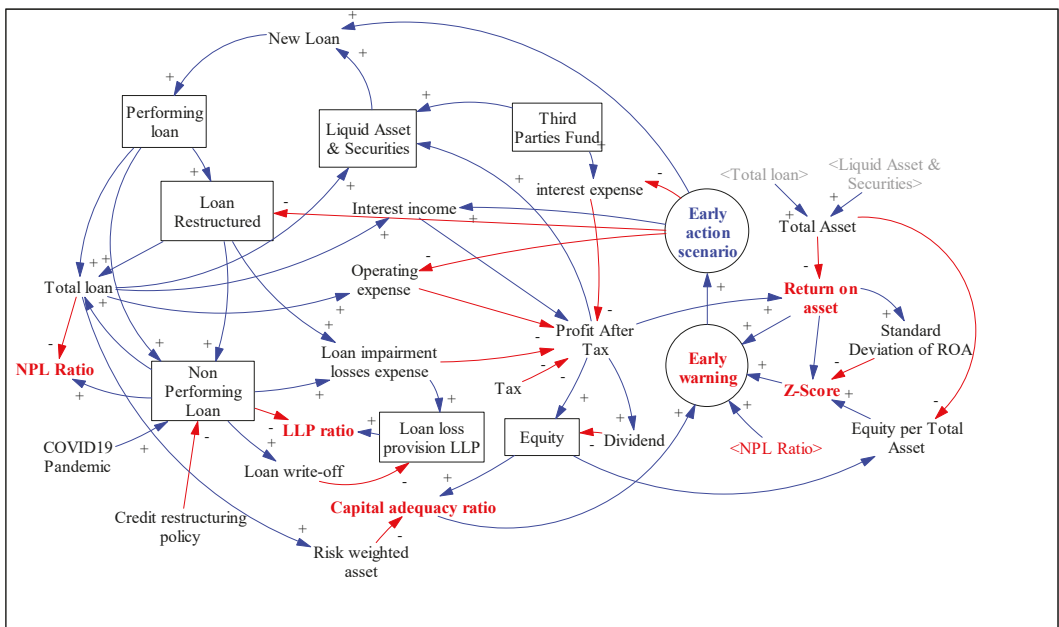
$$\text{Capital adequacy ratio (CAR)} = \frac{\text{Equity}}{\text{Total risk-weighted asset}} \tag{3}$$

$$\text{Non-performing loan (NPL) ratio} = \frac{\text{Non-performing}}{\text{total loan}} \tag{4}$$

$$\text{Loan loss provision (LLP) ratio} = \frac{\text{Loan loss provision}}{\text{Non-performing loan}} \tag{5}$$

### 3.1. Causal Loop Diagram of Early Warning Early Action Simulation Model

The structure of the simulation model was prepared based on the account components in the financial statements, transaction flows to earn profits, early information on bank solvency risks, and early actions to mitigate these risks. This was described as a causal-loop diagram in Figure 2 to show the transaction flow of the banking business activities. The positive link shows a unidirectional or positive causality relationship between the two structures. In contrast, a negative link shows an inverse or negative causality relationship between the two structures.



**Figure 2.** Causal-loop Diagram of Early Warning Early Action Model (Source: Author). The + sign indicates a unidirectional relationship between two variables, while the – sign indicates an inverse relationship between the two variables

When conducting the intermediary function, the banking business receives third-party funds (TPF) or savings that could be converted into loans to obtain an interest income. When interest income covers the interest expense, operating expense, loan impairment losses and tax, the bank reports some net income as additional capital. During the COVID-19 pandemic crisis, interest income decreased, while loan impairment losses increased, meaning that banks faced an increased solvency risk.

The early warning indicators of banking solvency risk used in this model appear in terms of ROA, NPL Ratio, CAR, and Z-Score. Any weakening in these indicators forms the basis for determining early action policy scenarios to improve the conditions. Therefore, this research simulated early action scenarios to overcome the potential weakening of banking solvency risks when the loan restructuring policy is revoked in March 2023. The scenarios include:

- a. Promoting loan growth or new loan policy to increase performing loans, to obtain more interest income and strengthen ROA, CAR, and Z-Score. However, when economic growth is abnormal, new loans should be selectively added to avoid additional NPL.
- b. Interest management is carried out by adjusting the loan interest rate and the savings interest rate to obtain an optimum net interest margin.
- c. The efficiency of operating expenses, including bank overhead, employee costs, and other expenses could reduce the ratio of operating expenses to income.
- d. Combined policy of (a), (b) and (c) above.

### 3.2. Stock Flow Diagram of Early Warning, Early Action Simulation Model

For simulation purposes, the relationship between the structure of financial transactions depicted in the causal-loop diagram in Figure 2 was operationalized into a stock-flow model, whose symbol is presented in Table 1. The structure of the balance sheet in the financial statements, consisting of equity, performing loans, third party funds and others in Figure 2, are categorized as stock because they have a balance at a certain time. In this situation, changes in stock balance are determined by the rate of inflows and outflows per unit time. The rate is determined by the multiplication of the stock and a constant variable, either directly or through several calculation stages using the auxiliary function.

**Table 1.** Symbols of Stock-Flow Diagram in Powersim Professional 10© (Sterman 2000).


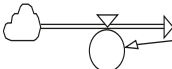
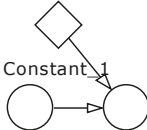



Symbol	Definition
	The symbol of STOCK is to declare variables with an accumulation derived from the previous value plus the difference between inflows and outflows. $\text{Stock}(t) = \int_{t_0}^t (\text{Inflow}(s) - \text{Outflow}(s))ds + \text{Stock}(t_0)$ $d(\text{Stock})/dt = \text{Inflow}(t) - \text{Outflow}(t).$
 Rate of loan market	The symbol of RATE states the formulation of the amount of the stock inflow and outflow in the system in a certain time unit. For example, the rate of loan market = \$100/month.
 Aux B      Aux	The symbol of AUXILIARY or AUX is used to formulate the equation rate by defining the determining factors of the rate equation separately. Additional equations are substituted for each other and several separate rate equations. For example, $\text{Aux} = \text{Aux B} \times \text{Constant}$

Table 1. Cont.

Symbol	Definition
 Constant_1	The symbol of CONSTANT is a function of a certain number, the input for the auxiliary or equation rate in the model, its value remains in the simulation period. It is used to simulate management policies, such as loan interest rate income and saving interest rate expense policies.
	The symbol of ARROW indicates the flow of information from one variable (auxiliary, stock, constant, level) to another.
Target loan to deposit ratio LDR assumption 	The symbol of GRAPH contains certain parameter functions to explain other parameters/quantities.

Stock-flow diagrams are developed based on bank financial statement accounts, including the financial assets account group (Figure 3), liabilities account group (Figure 4), and equity and statement of profit or loss (Figure 5). The formulation used to calculate the changes in the account is given in Appendix A.

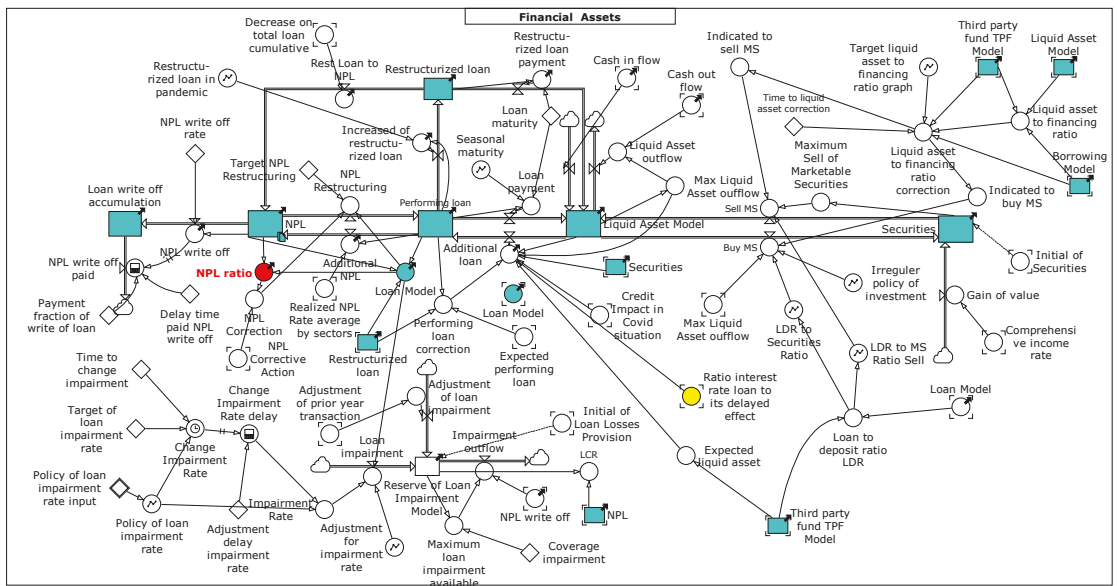


Figure 3. Stock-flow Diagram of Financial Assets (Source: Author).

The financial assets account diagram shows the cycle of investment transactions to earn interest income and maintain liquidity. In this situation, the bank prioritizes its liquid assets for investment in performing loans and generating high returns, although it is necessary to anticipate the risk of loan default. A defaulted loan then could be restructured and controlled as a restructured loan, while a defaulted loan that could not be restructured could then be administered as an NPL. Since eliminating NPL write-off reduces capital, the bank forms a loan lost provision (LLP). The NPL ratio is the early warning of loan risk, which must not exceed 5%. The bank maintains adequate levels of liquidity in the form of liquid assets and securities. The total balance between the two financial assets can meet the transaction payment needs for the next 1 month. Investment in securities generates interest income.

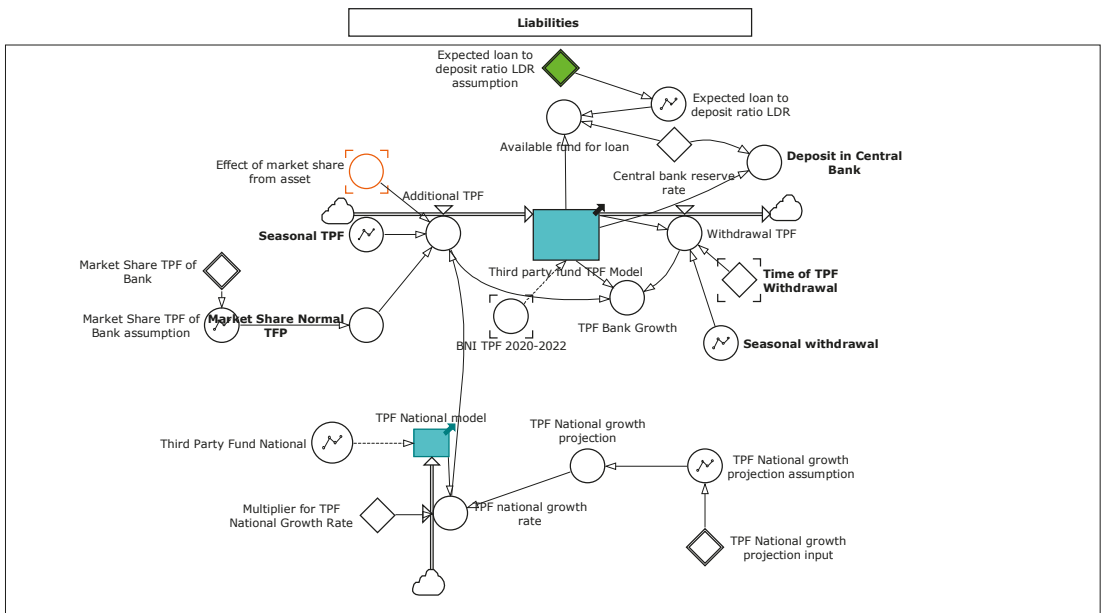


Figure 4. Stock-flow Diagram of Liabilities (Source: Author).

In the research design, the impact of changes in loan interest rates on additional loans is explained in the function of the interest rate loan to its delayed effect ratio variable in the additional loan formula in Table A1. If the annual interest rate of loan is increased, it will have a negative impact on additional loans.

The stock-flow diagram of liabilities illustrates the transaction flow of the third-party fund (TPF) originating from the addition and withdrawal of TPF funds from savers, as presented in Figure 4. An additional TPF is determined based on the national savings fund growth and the bank’s market share. After deducing the allocation of statutory reserves requirements at Bank Indonesia, the remaining TPF funds became available funds for new loans to debtors.

Furthermore, for deposit growth, we use the variable size of bank assets. This is based on the Indonesia Banking Survey 2017 conducted by PWC. It can be seen that the amount of bank assets has a strong correlation with additional third-party funds. Furthermore, additional loans at Bank BRI and Bank Mandiri are encouraged because they have more extensive networks and access to customers. Therefore, in this study the effect of market share from assets is used as a reinforcing variable for additional third-party funds. Moreover, most of the third-party funds of Bank BRI and Bank Mandiri come from the government institutions and state-owned companies which are not sensitive to the amount of interest rates on deposit. The explanation is shown in the Figure 4.

The stock-flow diagram of profit, loss, and equity in Figure 5 is developed through the accounts that make up income and expenses, as well as other equity transactions. Income is calculated before and after tax, which regularly changes following the banking business model. However, there are some irregular transactions that change the equity, including buy-back of stock, adjustments of expenses for transactions in previous years, employment benefit adjustments, and gains or losses of financial assets. The indicators of bank solvency risk that were analyzed in this paper are CAR and Z-Score.

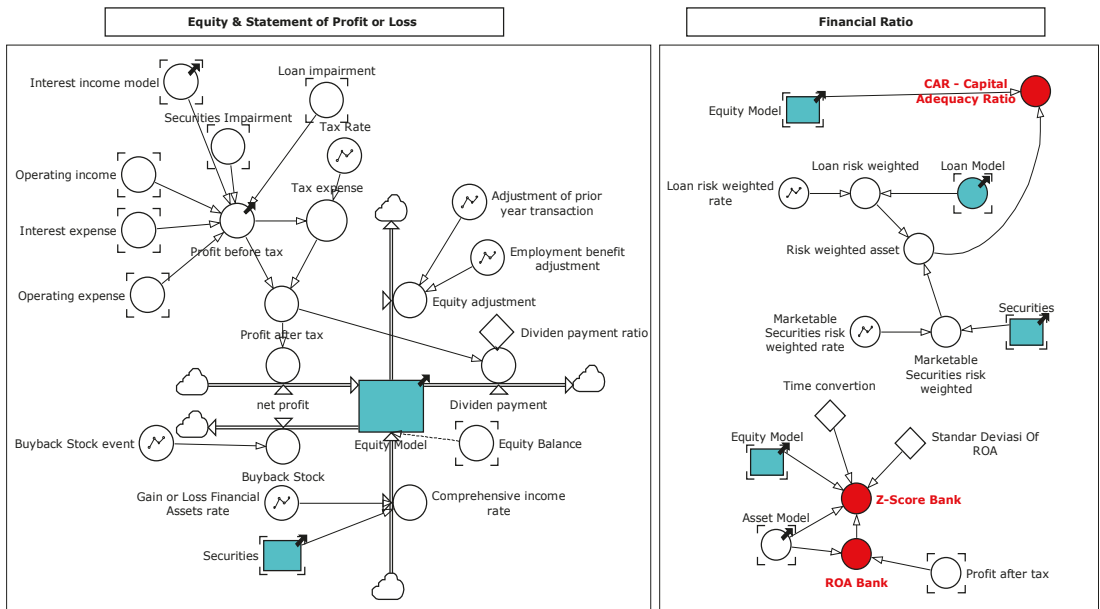


Figure 5. Stock-flow Diagram of Equity, Statement Profit or Loss and Financial Ratio (Source: Author).

4. Results and Discussion

4.1. Model Validation and Baseline of Bank Financial Ratios

The model was tested to determine its accuracy for further simulations. The test involved comparing the simulation results of several financial statement accounts with historical data in the 1st period (January 2020) to the 18th period (June 2021). The model output accuracy was measured using the degree of correlation (r) and the mean squared error (MSE). Table 2 shows the data from the fit model testing on the simulation results of BBRI and BMRI. The data described that the model produces financial reports with a relatively similar trend to the historical data. It has a relatively high r-value indicator of between 92.40% and 99.71% and a low mean squared error (MSE) account close to 0%. Therefore, the model is accurate for further simulation.

Table 2. Model Fits Testing (Source: Author).

Account	BBRI		BMRI	
	r	MSE	r	MSE
Loan	99.71%	0.004%	98.95%	0.009%
Third Party Fund	92.40%	0.034%	99.68%	0.006%
Equity	99.34%	0.010%	99.50%	0.013%

The baseline financial ratio data generated by the model are referred to the projection of a bank’s financial report for the period from 2020 to 2023, produced by the financial report stock-flow diagram (Figures 3–5). It is compiled based on the assumptions of loan and savings growth, interest income rate, and the interest expense rate for BBRI and BMRI. The assumptions for BBRI are as follows: third-party fund growth is 7.50%, loan growth is 7.40% per year, the average interest income rate is 9.97% per year, and interest expense rate is 2.30%. BBRI is the oldest and largest bank in Indonesia and operates 10,396 service offices with 125,602 employees. The portion of SMEs loans to total lending until the end of June 2021 reached 80.62%. BBRI is listed as the bank with the largest micro-customer base in the



world and lending to the micro-segment continues to increase because it is considered to provide higher yields.

Meanwhile, BMRI input data consist of the average third-party fund growth of 6.50%, the average loan growth of 6.45%, the interest income rate of 7.09% and the interest expense rate of 1.83% pa. BMRI's wholesale credit segment accounts for 51% of the total loans and is the driving force behind the credit growth. As of 30 June 2021 (period 18th), BMRI's office network comprises 2426 branches spread throughout Indonesia, with 38,247 employees. BMRI is the second largest bank in Indonesia in terms of total assets. The majority shareholder of BMRI and BBRI is the Government of the Republic of Indonesia.

The baseline data of BBRI and BMRI in Table 3 show that the banking solvency conditions, including the CAR and Z-Score, decreased during the COVID-19 pandemic in 2020 (period 1–12), but then increased, starting at the 18th period. The NPL ratio is still below the maximum NPL limit of 5% because it was supported by credit restructuring policies. After the policy is revoked, there is potential for NPL to arise from the high ratio of loans that are restructured to total loans, which reached 19% for BBRI and 12% for BMRI. To cover NPL risk, the bank strengthened its LLP, increasing the LLP to NPL ratio by 4.6 times in the 48th period for BBRI and 3.13 times for BMRI. The increase in reserves is to anticipate the possibility of debtors remaining in default even though credit restructuring has been carried out. To strengthen capital, it is assumed that dividends will not be distributed in the years 2022 and 2023 (from the 25th to the 48th period).

**Table 3.** Baseline Financial Ratio of BBRI and BMRI (Source: Annual Report).

Period	BBRI					BMRI				
	CAR	ROA	NPL	LLP	Z-Score	CAR	ROA	NPL	LLP	Z-Score
1	24.02%	0.18%	2.06%	2.12	580	26.41%	0.16%	2.39%	1.47	305
3	20.16%	0.15%	2.15%	2.74	518	22.27%	0.25%	2.66%	2.34	254
6	21.51%	0.15%	2.20%	2.45	534	24.79%	0.03%	2.52%	2.56	266
9	21.24%	0.13%	2.43%	2.42	536	23.17%	0.09%	2.71%	2.54	261
12	21.65%	0.08%	2.70%	2.47	535	23.44%	0.06%	2.92%	2.65	258
15	23.20%	0.12%	3.05%	2.53	570	23.85%	0.19%	3.08%	2.54	265
18	23.15%	0.12%	3.23%	2.69	581	24.19%	0.18%	3.14%	2.55	267
21	23.56%	0.12%	3.26%	2.97	592	24.49%	0.17%	3.13%	2.60	270
24	23.22%	0.09%	3.23%	3.35	586	24.84%	0.16%	3.10%	2.64	272
27	23.41%	0.16%	3.18%	3.56	589	25.07%	0.13%	3.10%	2.70	274
30	23.77%	0.17%	3.16%	3.71	602	25.32%	0.13%	3.09%	2.77	275
33	24.54%	0.19%	3.15%	3.87	626	25.49%	0.14%	3.07%	2.85	276
36	24.75%	0.20%	3.14%	4.01	634	25.65%	0.14%	3.06%	2.91	277
39	25.55%	0.20%	3.12%	4.17	659	25.75%	0.15%	3.05%	2.97	280
42	25.88%	0.20%	3.10%	4.33	669	25.82%	0.14%	3.04%	3.03	281
45	26.26%	0.20%	3.10%	4.47	679	26.00%	0.15%	3.03%	3.09	283
48	26.55%	0.21%	3.09%	4.60	691	26.08%	0.15%	3.03%	3.13	284

#### 4.2. Early Warning on the Impact of Loan Restructuring Policy Revocation in March 2023

In this section, the impact of the OJK Loan Restructuring Policy revocation in March 2023 is simulated on the additional potential default for outstanding Loan Restructured that gradually increase the NPL starting period (the 40th). The three scenarios for the default rate of restructuring loan balances are 10%, 20%, and 30%, which describe the bank's ability to maintain the quality of restructured loans and their effects on the banking solvency risk indicators, including NPL, ROA, CAR, and Z-Score.

As an early warning for BBRI, Figure 6 displays the results of the simulation for banking solvency risk. The simulation was carried out for the default potential on the projection of restructured loan balance at the 39th period (March 2023), which reached IDR 185 trillion. The default rate scenario consists of 30%, 20% and 10%, which describes the BBRI's ability to maintain the quality of the restructured loans. If 70% of the restructured loans can be optimally managed by worsening the collectability, then the default rate scenario is 30%, etc.

Based on the default rate scenarios of the restructured loan of 30%, 20%, and 10%, the NPL ratio will gradually increase from the 40th period until the 48th period that can reach 6.34%, 5.38% and 4.4%, or by 105.24%, 74.19% and 43% from the baseline. According to regulation, NPL should not exceed 5%. The increase in NPL has a negative impact on ROA, CAR and Z-Score, but for BBRI, this is not significant. In the 30% default rate scenario, CAR and Z-Score only decreased by 1.33% and 0.74%, respectively. This is because BBRI has an LLP ratio 4.64 times above the NPL at the baseline position. LLP absorbs the increase in impairment losses due to an increase in NPL (Figure 7). The LLP ratio decreased from 4.65 baseline position to 1.93 in the 48th period at the 30% default rate scenario. However, this LLP ratio is sufficient to cover the need for NPL elimination because it is still above the minimum ratio of 1.00 required by the regulator.

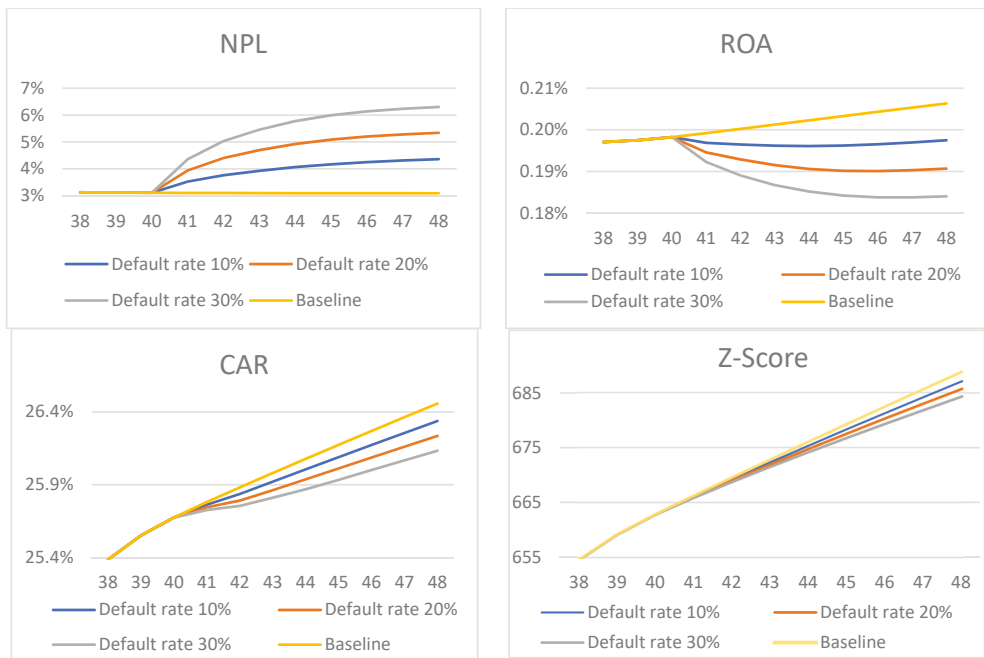


Figure 6. Early Warning for BBRI Solvency Risk (Source: Author).

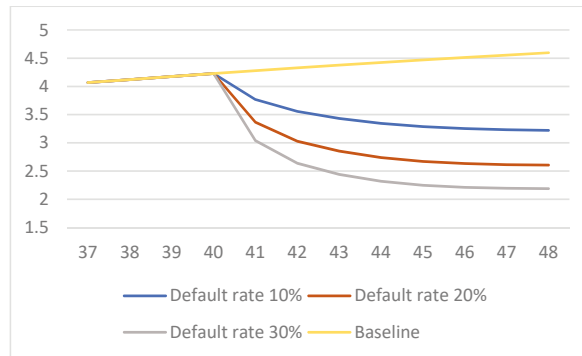


Figure 7. LLP of BBRI.

The solvency risk simulation of BMRI presented in Figure 8 is based on a model simulation of the loan restructured position at the period 39th (March 2023): IDR 120 trillion. The NPL ratio gradually increases up to the simulation period, namely, the 48th period (December 2023), which reached 6.25%, 5.24%, and 4.20% for the default scenario by 30%, 20%, and 10%. This scenario describes the bank’s ability to control restructuring credit payments. The NPL ratio increased by 106.11%, 72.72% and 38.63% from the baseline position.

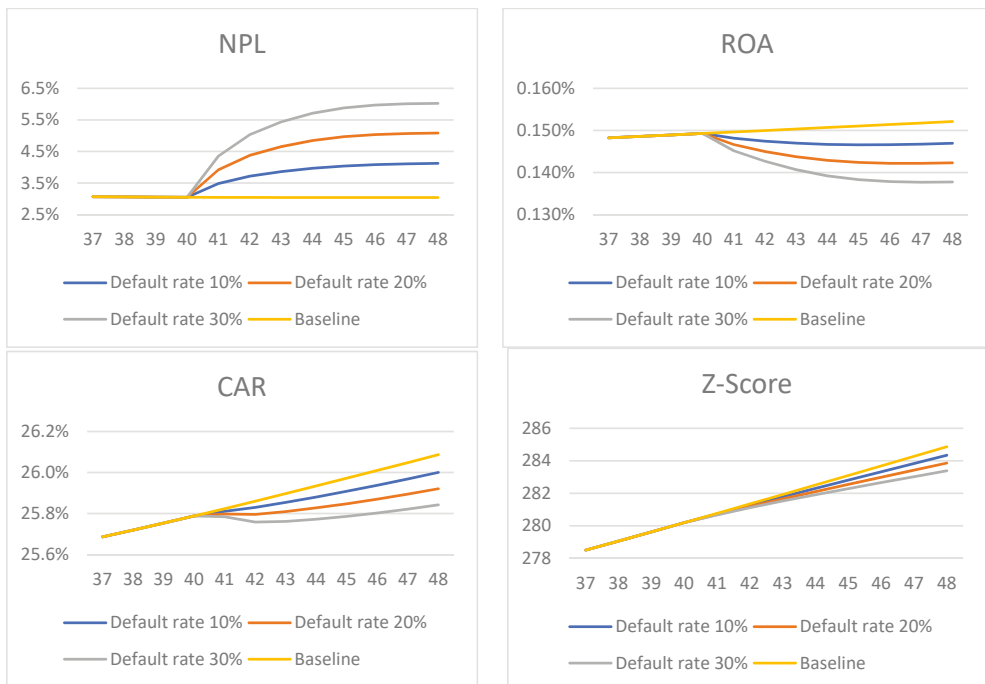


Figure 8. Early Warning for Solvency Risk of BMRI.

An increase in NPL will reduce profits, so that it has a negative impact on ROA, CAR and Z-Score. Based on a 30% default rate scenario, the CAR and Z-Score of BMRI ratios decreased by 1.14% and 0.70% from the baseline position, which was lower than

the increase in NPL ratio at the 48th period. Even though the CAR decreases, the ratio is still above the BMRI minimum capital requirement of 9.75%. BMRI strengthened the LLP to absorb loan impairment expense when NPL increases so that it does not harm CAR and Z-Score, as shown in Figure 9. However, the strategy of strengthening the LLP has a negative impact on the achievement of bank profits because it creates a high loan impairment expense.

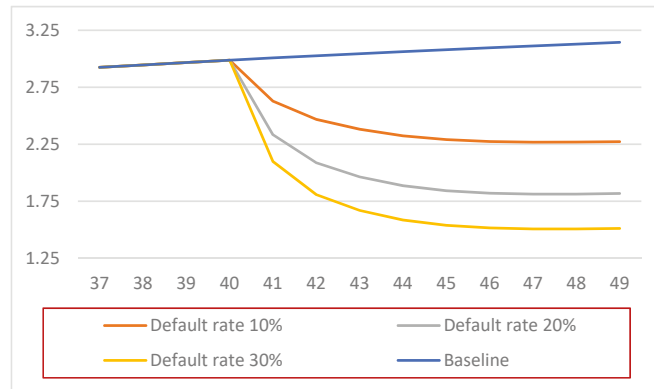


Figure 9. LLP of BMRI.

Based on the simulation, the solvency risk of BBRI and BMRI increased after the restructuring policy revocation, but both are still at safe solvency levels, in accordance with their respective CAR threshold. However, banks still need to strengthen the solvency level to deal with the potential default rate of a loan that is restructured by more than 30% when the credit restructuring policy is lifted in March 2023 and the economy is still recovering after the pandemic outbreak.

#### 4.3. Early Action to Strengthen Bank Solvency

After the early warning simulation modeling, early action simulation is identified to strengthen the banking solvency conditions. This research led to the development of four policy options, including interest rate management, new loan policy, decreased operating expenses, and a combined policy scenario. Using certain values for the main indicators needed in each policy option, further simulations are conducted to examine the changes in potential solvency risk through the CAR and Z-Score. The changes in these parameters show that the best policy produces the highest CAR and Z-Score.

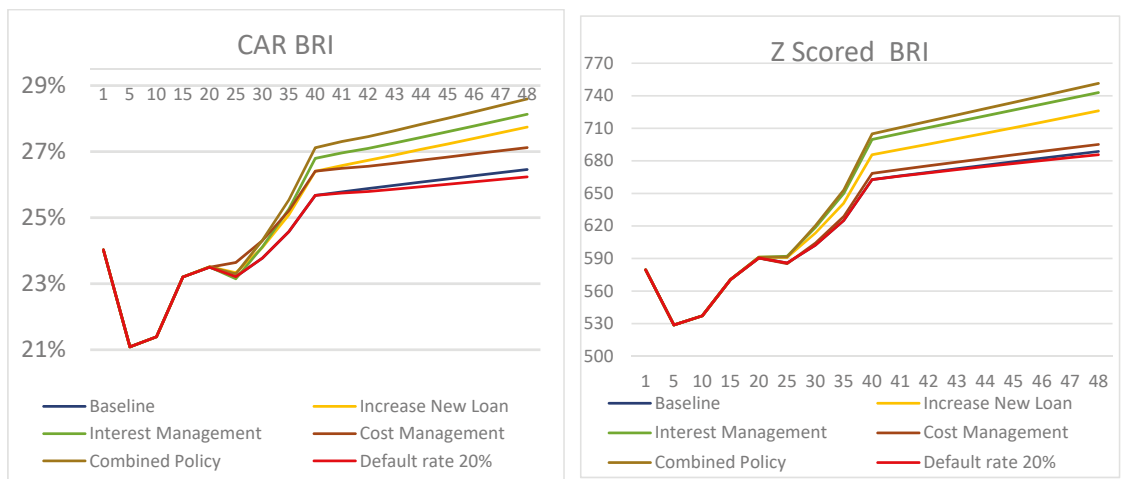
This research uses the parameters of interest expense rate and interest income rate for the interest rate management policy, loan to deposit ratio (LDR), for a new loan policy, operating expense rate, which is calculated by the percentage of total operating costs to the total loan to decrease the operating expense policy, as well as a combined policy that is a combination of the three scenarios. There is a potential for increasing NPL and decreasing CAR when the OJK loan restructuring policy ends. Based on the simulation, several policies and early actions were identified to strengthen banks' solvency. These should be implemented because the potential default rate of loan restructures could exceed 30%. Several alternative policy scenarios and examples, such as simulation results for BBRI and BMRI, are shown in Table 4.

**Table 4.** Early Action to Strengthen Bank Solvency.

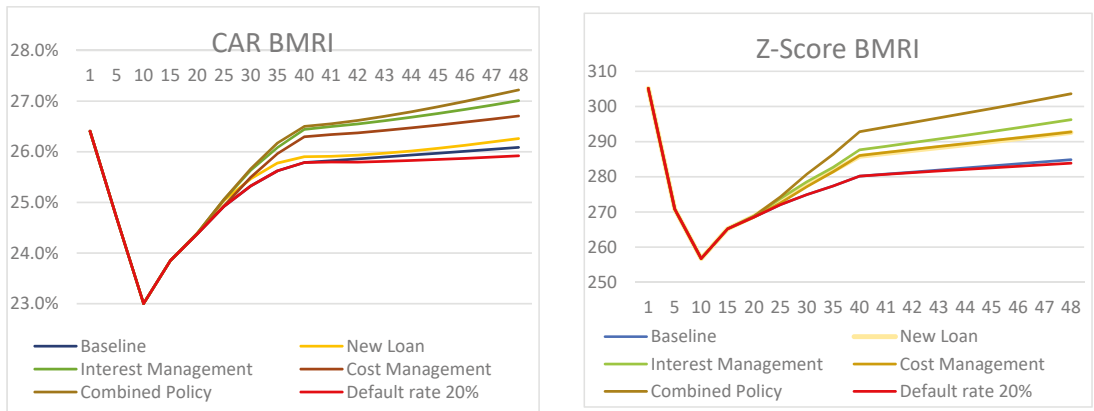
No	Policy Scenario	Policy Options (Early Action) to Strengthen Solvency for BBRI	Policy Options (Early Action) to Strengthen Solvency for BMRI
1	Interest rate management (policy for managing interest rates on loans and savings/deposits)	Decrease in interest expense rate (for third party funds) from around 2.66% at baseline to 2.24% per year Increase in interest income rate (for new loans) from around 9.97% at baseline per year to approximately 11.24% per year	Decrease in interest expense rate (for third party funds) from around 1.83% at baseline to 1.63% per year Increase in interest income rate (for new loans) from around 7.09% at baseline per year to approximately 7.97% per year
2	Increase new loan (policy to increase new loan)	Increased loan to deposit ratio from 88% at baseline to 91%	Increased loan to deposit ratio rate from 83% at baseline to 90%
3	Decreased operating expenses (policies to save bank operational costs)	Decrease in the ratio of operating expenses to total loans from 2.56% at baseline to 2.39% per year	Decrease in the ratio of operating expenses to total loans from 2.80% at baseline to 2.32% per year
4	Combined policy (policy combination)	Combination of Policy 1 to 3	Combination of Policy 1 to 3

The target levels of the investigated indicators, namely loan interest rates, deposit interest rates, loan to deposit ratio (LDR) and cost to income ratios (CIR) are determined based on actual data achieved by banks at the end of 2019 or bank performance conditions prior to COVID-19. The bank’s solvency level parameter data will certainly move in line with the changes of loan performance. The choice of policy scenarios is based on the simulation results for the CAR level during the simulation period, and the best policy will be selected based on the ability of the policy to generate the highest CAR ratio.

Figures 10 and 11 show the simulation results of the four early action policy scenarios for BBRI and BMRI to anticipate the increase in solvency risk when the credit restructuring policy is revoked in the 39th period. As an early action, some of the policies in Table 3 can be implemented during the period before the OJK policy is revoked, or from July 2021 (19th period) to December 2023 (48th period). An effective policy is a policy that can encourage a higher CAR and Z-Score compared to other policy options.



**Figure 10.** Early action Simulation of BBRI.



**Figure 11.** Early Action Simulation of BMRI.

At BBRI, the policy simulation of interest rate management, new loan policy, the policy of a decrease in operating expense, and combined policy scenarios resulted in higher CAR and Z-Score levels than the position at default rate 20% (Figure 10). Similarly, the Z-Score for the four policy scenario options at BBRI has the same pattern, with changes in CAR compared to the baseline level.

The combined policy pushed the CAR and Z-Score ratio of BBRI from 26.46% and 689 to 28.78% and 757, or increased by 8.76% and 9.9%, respectively, above the baseline position at the 48<sup>th</sup> month. The policies that resulted in the highest CAR and Z-Scores, after the combined policy, are the policy of decreasing operating expense, interest management policy, and new loan policy. The combined policy of increased revenue and saved costs is the best option to effectively boost CAR and Z-Score in BBRI under the recovering economic conditions caused by the COVID-19 pandemic.

For BMRI, based on the two parameters of CAR and Z-Score on Figure 11, the combined policy causes the highest changes in CAR and Z-Score values, followed by the policy of decreasing operating expenses, interest management policy, and new loan policy. Moreover, the combined policies strengthen the solvency of BMRI compared to other policies. Therefore, the combination of policies to increase revenue and save costs is the best option to effectively boost CAR in BMRI under abnormal economic conditions, due to the impact of the pandemic outbreak.

The combined policy also has a high sensitivity level to boost BMRI's CAR and Z-Score by 20.23% and 24.56% from the baseline position for the 48th period. In contrast, policies with low leverage in the current economic conditions are new loan policies. This is because the demand for new loans is still low, due to the COVID-19 pandemic.

#### 4.4. Discussion

Several important points should be discussed regarding the simulation of the loan restructuring policy revocation that began in March 2020. The first is to evaluate the potential of the default on the restructured loans. This evaluation allows banks to control the collectability of restructured loans to avoid them deteriorating or becoming NPLs (Bauer et al. 2021). However, evaluation should be monitored through the bank guidance to the debtors with the potentially non-performing loans. This could be implemented by visiting the debtors and their businesses, or conducting some on-site monitoring, to analyze the respected debtors' ability to pay. There should be some concerns from banks regarding the provision of advice to debtors regarding business management to maintain and improve the payment capacity of the restructured loans. Therefore, loan monitoring by

banks suppresses non-performing loans and improves financial performance (Duong et al. 2020; Hidayat et al. 2021).

In a normal situation (not a pandemic), the increase in loan interest rates and a decrease in deposit rates will greatly depend on the level of price elasticity of each product. In this case, if the loan interest rate decreases, the demand for loan from the prospective debtors will increase, and if the deposit interest rate decreases, deposit placement activities will decrease.

The COVID-19 condition has led to government intervention in handling the situation through restrictions on community activities. This is the main reason that causes less than optimal new loan growth or in other words, although loan interest rates decreases, the demand of prospective debtors obtaining the new loan does not increase. This is because people still in doubt of their ability to repay loans.

However, the design of this study has considered the factors that influence the rate of loan growth (additional loan) with the following explanation:

- The increase in new loans is not only influenced by loan interest rates, which tend to decline during the pandemic, but is greatly influenced by the COVID-19 condition with the level of public and business trust as potential debtors being quite low due to the tightening economic activities and doubts about their ability to loan repayment.
- The increase in new loans is influenced by the level of bank liquidity, which was quite abundant during a pandemic. However, with the level of trust from the public and business that had not recovered as well as the economic activity that had not yet recovered, the bank could not carry out the new loan growth optimally.

Taking into account the simulation results, it can be conveyed that in the COVID-19 period there are conditions, namely: abundant bank liquidity, declining loan interest rates and declining deposit interest rates. This can then be adjusted to post-COVID-19 conditions, where the loan interest rate can be increased, namely from a declining interest rate to the original interest rate, in line with increasing public and business confidence in the conditions of post COVID-19 and the recovery in economic activity.

The simulation results also show that the banks have a fairly good level of LLP and CAR to absorb the solvency risk. Therefore, although there is an increase in NPL, this does not have a significant impact on CAR and Z-Score (Agenor and Zilberman 2015). A high level of LLP reduces the bank solvency risk but increases the loan impairment losses, and suppresses profit and capital growth. Therefore, banks face a trade-off between solvency and profitability (Zheng et al. 2019).

There is a challenge in the simulation of policy scenarios by banks to prepare better action plans in response to worsening NPLs when the restructuring policy is revoked. This allows for the impact of the policy on the bank solvency to be known before it is implemented (Paiva et al. 2020; Asadollahi et al. 2021). Moreover, it enables banks to prepare for the existing policy scenario options (Morecroft 2015).

The model has been developed into a self-simulation facility that could be implemented by the bank management to enable banks to deal with the potential solvency risks using their own data. Banks could calculate the level of solvency and other risks as a consequence of the COVID-19 pandemic through a simple interface that generates early warning and early action. Figure 12 shows the Bank Solvency Risk Self-Simulation Interface developed in this research. Three parts were prepared in the application. The first part shows data input instruments for potential defaults on restructured loans. The second part shows input instruments for bank policy parameters to manage solvency risk through four policy scenarios. The third part displays the simulation results of bank solvency indicators, including NPL Ratio, CAR, ROA and Z-Score.

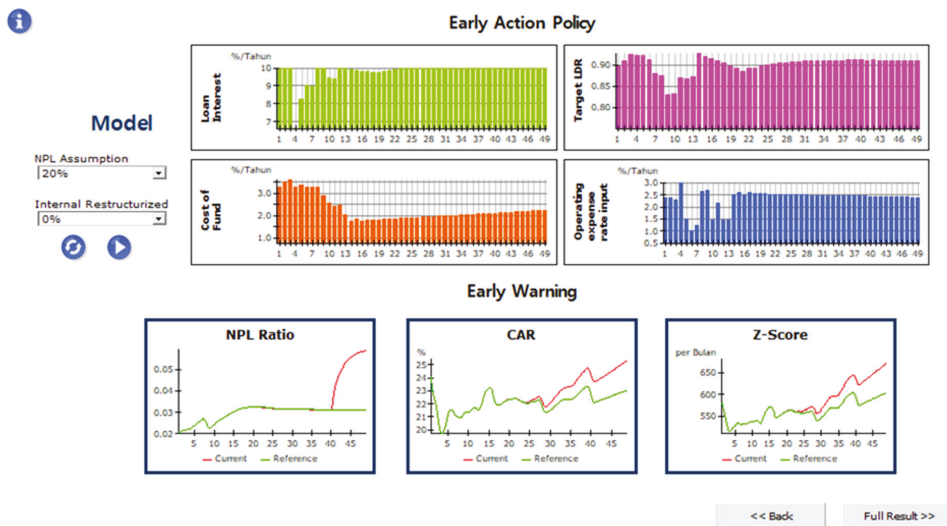


Figure 12. Bank Solvency Risk Self-Simulation Interface Developed in the Research.

The implementation of a self-simulation facility requires bank officers to provide input data or assumptions regarding the estimated percentage of restructured loan defaults and the potential non-performing loans. These inputs produce an early warning about solvency risk. Furthermore, bank management could prepare inputs for each solvency risk management policy provided by applying the required parameters. After obtaining the input data for the four policies, the application generates new conditions, providing the policy by displaying the NPL, CAR, and Z-Score as early actions for the bank management.

Based on the early warning and early action information, using self-simulation, the bank could implement the policy that produces the highest CAR and Z-Score at the first opportunity. The earlier the best policy is implemented, the better prepared banks become to face the loan restructuring policy revocation that will take place in March 2023. After the policy is implemented, and during the lead up to the policy revocation, banks could still perform self-simulation. However, they should consider the current conditions of loan performance through the NPL ratio. They could also continuously monitor or update bank's readiness to face solvency risk after the revocation of the OJK loan restructuring policy.

## 5. Conclusions

This article develops an early warning system model for bank bankruptcy risk and a simulation of management policy response. The development of the model with a system dynamics methodology adds theoretical knowledge about the flow of the bank financial transactions that caused the bank bankruptcy risk, and then produces simulations and management policy choices to reduce the potential risks. By identifying the flow in the system dynamics, bank management can develop appropriate risk mitigation policy choices according to the symptoms that have arisen.

System dynamics methodology is used to build models and perform early warning and early action simulations to help banks identify solvency risks earlier and design policies and strategies to mitigate the risk. Early warnings regarding bank solvency risk could be identified through simulations and early actions could be taken to overcome the potential risks and problems after the restructuring policy revocation. To deliver the robust model of solvency risk, this research used the publicly accessed data from two banks and analyzed some financial ratios based on the financial statements. To enable banks to use their data,



this research provided a self-simulation facility, so that bank management could obtain a more accurate solvency risk prediction. It is suggested that future research could consider not only solvency risk but also the liquidity and market risks.

The limitations of the analysis that carried out in this paper, among others, that it only discussed the potential loan risk as the beginning of the bankruptcy risk and has not discussed the other causes of the loan risks such as the debtor moral hazard, the weak analysis of creditworthiness, the declining of the payment capacity of the debtors due to the pandemic COVID-19 and the specific economic sectors that experienced the high level of loan risks. It is suggested that future research could consider not only the loan and solvency risk but also the liquidity and market risks in the model. Further, the upcoming research is suggested to discuss the causes of the bankruptcy risks that have not been analyzed in this article.

**Author Contributions:** T.H. carried out the conception, design of the work, and drafting the article. D.M. reviewed the literature, methodology and gave final approval of the article. S.R.N. reviewed data analysis and interpretation. F.A. worked on data collection and the modelling. M.A.N.S. worked on the simulation. All authors have read and agreed to the published version of the manuscript.

**Funding:** The research presented in this scientific article was self-funded.

**Data Availability Statement:** The data presented in this study are available on request from the corresponding author.

**Conflicts of Interest:** The authors declare no conflict of interest.

## Appendix A

**Table A1.** Formula of Variable in Stock-flow Diagram.

Variabel	Formula
Performing Loan	Initial Performing Loan + (Loan Payment – Additional Loan) + (NPL Restructuring – Additional NPL) – Performing Loan to Restructured Loan
Loan Payment	(Loan Maturity * Performing Loan) * (1 + Seasonal maturity)
Additional Loan	(MIN (Max Liquid Asset Outflow, If ((Marketable Securities Model + Liquid Asset Model)>Expected liquid Asset, Performing loan correction, 0<<IDR Million/Month>>) * (Credit Impact in COVID situation/ Ratio interest rate loan to its delayed effect))
Additional NPL	Performing loan * Realized NPL Rate Average by Sectors
NPL Restructuring	(MAX (Target NPL Restructuring, (Target NPL Restructuring + NPL Correction))/Time to Restructuring) * Loan Model
NPL	Initial NPL + (Additional NPL – NPL Restructuring) + Rest Loan to NPL – NPL Write off
Rest Loan to NPL	MIN (Maximum Restructured Loan Outflow, decrease on total loan cumulative)
NPL write off	(Non performing loan NPL * NPL write-off rate)
Restructured Loan	Initial Restructured Loan + Performing Loan to Restructured Loan – Rest Loan to NPL – Restructured Loan Payment
Restructured Loan Payment	MAX(0<<IDR Million/ month>>,MIN(Maximum Restructured Loan Outflow, Loan Maturity/Multiplier Maturity Rate in Restructured Implemented * Restructured Loan))
Liquid Asset Model	Initial Liquid Asset + Loan Payment – Additional Loan + Restructured Loan Payment + Cash Inflow – Cash Outflow – Buy Marketable Securities (MS) – Sell MS
Cash Inflow	Interest income + Operating income + New borrowing + Additional TPF + NPL Write Off Paid + Fixed Asset Disposals

Table A1. Cont.

Variabel	Formula
Cash Inflow	(Operating expense – Depreciation)+ Additions of Fixed Asset + Borrowing Payment + Withdrawal TPF + Interest Expense + Dividen Payment + Tax expense + Buyback Stock
Sell MS	MIN (Maximum Sell of Marketable Securities, Indicated to sell MS * LDR to MS Ratio Sell)
Buy MS	MIN ((Indicated to buy MS * LDR to MS Ratio Buy)*1+Irreguler policy of investment, Max Liquid Asset outflow)
Securities	Initial Securities + Buy MS – Sell MS + Gain of Value
Reserve of Loan Impairment Model	Initial of Reserve of Loan Impairment Model + Loan Impairment – Impairment Outflow + Adjustment of Loan Impairment
Loan Impairment	(Loan Model * Impairment Rate)
Impairment Outflow	(MIN (Maximum Loan Impairment Available, NPL write off))
NPL Ratio	Non performing loan NPL/Loan Model
Loan Loss Provision (LLP)	Reserve of Loan Impairment Model/Non performing loan NPL
Third Party Fund (TPF)	Initial TPF + Additional TPF – Withdrawal TPF
Additional TPF	TPF national growth rate * Seasonal TPF * (Market Share Normal TPF * Effect of market share from asset)
Withdrawal TPF	(Third party fund TPF Model/Time of TPF Withdrawal) * (Seasonal withdrawal)
Equity Model	Initial Equity + Net Profit – Equity Adjustment – Dividend Payment – Buy back of Stock
Net Profit	(Interest Income – Interest Expense + Operating Income – Operating Expense – Loan Impairment -Tax expense)
Equity Adjustment	Adjustment of prior year transaction + Employment Benefit Adjustment
Dividend Payment	Profit After Tax * Dividend Payout Ratio
Buy Back of Stock	Buy back decision or event
Capital Adequacy Ratio (CAR)	Equity Model/Risk Weighted Asset * 100<<=>
ROA	Profit After Tax/Asset Model
Z-Score	(ROA + (Equity Model/Asset Model))/Standard Deviation of ROA

## References

- Agenor, Pierre-Richard, and Roy Zilberman. 2015. Loan Loss Provisioning Rules, Procyclicality, and Financial Volatility. *Journal of Banking and Finance* 61: 301–15. [CrossRef]
- Aksu, İbrahim, and Mehmet Tursun. 2021. Analysis of Responsibility Centers Performance in Businesses By System Dynamics Method. *Journal of Accounting and Taxation Studies* 14: 949–66. [CrossRef]
- Al-Kharusi, Sami, and Sree Rama Murthy. 2020. Financial stability of GCC banks in the COVID-19 Crisis: A simulation approach. *The Journal of Asian Finance, Economics, and Business* 7: 337–44. [CrossRef]
- Asadollahi, Seyyed Yahya, Ali Asghar Taherabadib, Farhad Shahvisic, and Farshid Kheirollahi. 2021. Modeling Liquidity Risk Management in Banking Using System Dynamics Approach. *Advances in Mathematical Finance and Applications* 6: 493–514. [CrossRef]
- Bala, Atkinson, Arshad Bilash Kanti, Fatimah Mohamed, and Kusairi Mohd Noh. 2017. *System Dynamics: Modelling and Simulation*. Singapore: Springer Science & Business Media.
- Bank Indonesia. 2021. Financial Stability Review No. 37. September. Available online: [https://www.bi.go.id/id/publikasi/kajian/Pages/KSK\\_3721.aspx#](https://www.bi.go.id/id/publikasi/kajian/Pages/KSK_3721.aspx#) (accessed on 24 October 2021).
- Barua, Bipasha, and Soburna Barua. 2021. COVID-19 Implications for Banks: Evidence from an Emerging Economy. *SN Business & Economics* 1: 19.

- Bastana, Mahdi, Mohammad Bagheri Mazraeha, and Ali Mohammad Ahmadvand. 2016. Dynamics of Banking Soundness Based on CAMELS Rating System. Paper presented at the 34th International Conference of the System Dynamics Society, Delft, The Netherlands, July 17–21.
- Bauer, W. Andreas, R. Sean Craig, José Garrido, Kenneth H. Kang, Kashiwase Kenichiro, Sung Jin Kim, Yan Liu, and Sohrab Rafiq. 2021. *Flattening the Insolvency Curve: Promoting Corporate Restructuring in Asia and the Pacific in the Post-C19 Recovery*. IMF Working Paper 2021/016. Washington, DC: International Monetary Fund.
- Danielsson, Jon, Robert Macrae, Dimitri Vayanos, and Jean-Pierre dan Zigrand. 2020. We Shouldn't Be Comparing the Coronavirus Crisis to 2008—This Is Why? Available online: <https://www.weforum.org/agenda/2020/04/the-coronavirus-crisis-is-no-2008> (accessed on 10 October 2021).
- De Vany, Arthur S. 1984. Modeling the banking firm: Comment. *Journal of Money, Credit and Banking* 16: 603–9. [CrossRef]
- Donnellan, John, and Wanda Rutledge. 2016. Agency Theory in Banking—Lessons from the 2007–2010 Financial Crisis'. *International Journal of Business and Applied Social Science* 2: 1–12. Available online: <https://ssrn.com/abstract=2940060> (accessed on 11 October 2021).
- Duggan, Jim. 2016. *System Dynamics Modeling with R*. Cham: Springer International Publishing Switzerland.
- Duong, Tam Thanh Nguyen, Hai Thanh Phan, Tien Ngoc Hoang, and Tien Thuy Thi Vo. 2020. The Effect of Financial Restructuring on the Overall Financial Performance of the Commercial Banks in Vietnam. *The Journal of Asian Finance, Economics, and Business* 7: 75–84. [CrossRef]
- García, Juan Martín. 2019. *Common Mistakes in System Dynamics*. Chicago: Independently Publishers, ISBN 9781791578787.
- Goodell, John W. 2020. COVID-19 and Finance: Agendas for Future Research. *Finance Research Letters* 35: 101512. [CrossRef]
- Gunnensen, Sverre Edvard. 2014. Predicting Corporate Failure Through a Combination of Intelligent Techniques. Ph.D. dissertation, Monash University, Melbourne, Australia.
- Hardiyanti, Siti Epa, and Lukmanul Hakim Aziz. 2021. The Case of COVID-19 Impact on the Level of Non-Performing Loans of Conventional Commercial Banks in Indonesia. *Banks and Bank Systems* 16: 62–68. [CrossRef]
- Henrard, Luc, and Ruben Olieslagers. 2004. Risk management of a financial conglomerate. In *Forum Financier-Revue Bancaire et Financière Bank en Financiewezen*. Brussels: Larcier, pp. 52–64.
- Hidayat, Taufiq, Dian Masyita, Sulaeman Nidar, Erie Febrian, and Fauzan Ahmad. 2021. The Effect of COVID-19 to Credit Risk and Capital Risk of State-Owned Bank in Indonesia: A System Dynamics Model. *WSEAS Transactions on Business and Economics* 18: 1121–36. [CrossRef]
- Islam, Tuahith, Christos Vasilopoulos, and Erik Pruyt. 2013. Stress-Testing Banks under Deep Uncertainty. Paper presented at 31st International Conference of the System Dynamics Society, Cambridge, MA, USA, July 21–25.
- Istiaq, Muhammad. 2015. Risk Management in Banks: Determination of Practices and Relationship with Performance. Ph.D. dissertation, The University of Bedfordshire, Luton, UK.
- Jensen, Michael C., and William H. Meckling. 1976. Theory of the Firm: Managerial Behavior, Agency Costs and Ownership Structure. *Journal of Financial Economics* 3: 305–60. [CrossRef]
- Knowles, John, Ken Nicholls, and Chris Bloor. 2020. Outcomes from a COVID-19 stress test of New Zealand banks. *Reserve Bank of New Zealand Bulletin* 83: 1–12.
- Korzeb, Zbigniew, and Pawel Niedziółka. 2020. Resistance of commercial banks to the crisis caused by the COVID-19 pandemic: The case of Poland. *Equilibrium. Quarterly Journal of Economics and Economic Policy* 15: 205–34. [CrossRef]
- Kunc, Martin, Michael J. Mortenson, and Richard Vidgen. 2018. A computational literature review of the field of System Dynamics from 1974 to 2017. *Journal of Simulation* 12: 115–27. [CrossRef]
- Kuritzkes, Andrew, Til Schuermann, and Scott M. Weiner. 2003. Risk Measurement, Risk Management and Capital Adequacy in Financial Conglomerates. *Brookings-Wharton Papers on Financial Services* 2003: 141–93. [CrossRef]
- Lang, Jan Hannes, Tuomas A. Peltonen, and Peter Sarlin. 2018. *A Framework for Early-warning Modelling with an Application to Banks*. European Central Bank Working Paper Series, No. 2182/October 2018. Frankfurt: European Central Bank.
- Leaning, Jennifer. 2016. The Path to Last Resort: The Role of Early Warning & Early Action. *Daedalus. Ethics, Technology & War* 145: 101–12.
- Lepetit, Laetitia, Frank Strobel, and Thu Ha Tran. 2020. An Alternative Z-score Measure for Downside Bank Insolvency Risk. *Applied Economics Letters* 28: 137–42. [CrossRef]
- Mayer, David G., and Hanno Stremmel. 2012. The Effectiveness of Capital Adequacy Measures in Predicting Bank Distress. Financial Markets & Corporate Governance Conference. Available online: <https://ssrn.com/abstract=2191861> (accessed on 10 October 2021).
- Morecroft, John D. W. 2015. *Strategic Modeling and Business Dynamics: A Feedback Systems Approach*, 2nd ed. Chichester: John Wiley and Sons Ltd.
- Oladimeji, Olufunke Olufunmi, Heather Keathley-Herring, and Jennifer A. Cross. 2020. System dynamics applications in performance measurement research: A systematic literature review. *Journal of Productivity and Performance Management* 69: 1541–78. [CrossRef]
- Paiva, Bernardo M. R., Fernando A. F. Ferreira, Elias G. Carayannis, Constantin Zopounidis, João J. M. Ferreira, Leandro F. Pereira, and Paulo J. V. L. Dias. 2020. Strategizing sustainability in the banking industry using fuzzy cognitive maps and system dynamics. *International Journal of Sustainable Development & World Ecology* 28: 93–108. [CrossRef]

- Pavlov, Oleg V., and Evangelos Katsamakas. 2021. COVID-19 and Financial Sustainability of Academic Institutions. *Sustainability* 13: 3903. [CrossRef]
- Petropoulos, Anastasios, Vassilis Siakoulis, Konstantinos P. Panousis, Theodoros Christophides, and Sotirios Chatzis. 2020. A Deep Learning Approach for Dynamic Balance Sheet Stress Testing. Available online: <https://arxiv.org/abs/2009.11075> (accessed on 15 September 2021).
- Pierson, Kawika. 2020. Operationalizing Accounting Reporting in System Dynamics Models. *Systems* 8: 9. [CrossRef]
- Rahmi, Yulia, and Erman Sumirat. 2021. A Study of The Impact of Alma on Profitability During the COVID-19 Pandemic. *International Journal of Business, Economics, and Law* 24: 54–65.
- Rose, Peter S. 1992. Agency Theory and Entry Barriers in Banking. *The Financial Review* 27: 323–54. [CrossRef]
- Samorodov, Borys, Halyna Azarenkova, Olena Holovko, Kateryna Oriekhova, and Maksym Babenko. 2019. Financial stability management in banks: Strategy maps. *Banks and Bank Systems* 14: 10–21. [CrossRef]
- Sapiri, Hasimah, Jafri Zulkepli, Norazura Ahmad, Norhaslinda Zainal Abidin, and Nurul Nazihah Hawari. 2020. *Introduction to System Dynamics Modelling and Vensim Software*. Sintok: UUM Press.
- Schuermann, Til. 2014. Stress Testing Banks. *International Journal of Forecasting* 30: 717–28. [CrossRef]
- Siregar, Reza Y., Anton H. Gunawan, and Adhi N. Saputro. 2021. Impact of The COVID-19 Shock on Banking and Corporate Sector Vulnerabilities in Indonesia. *Bulletin of Indonesian Economic Studies* 57: 147–73. [CrossRef]
- Smith, Alan D. 2010. Agency Theory and The Financial Crisis from a Strategic Perspective. *International Journal of Business Information Systems* 5: 248–67. [CrossRef]
- Sterman, Jhon D. 2000. *Business Dynamics: Systems Thinking and Modeling for a Complex World*. Boston: McGraw-Hill.
- Wu, Xiaoyu. 2014. *Banking Crisis Dynamics and Financial Risk Management*. Doctor of. Philosophy dissertation, The City University of Hong Kong, Hong Kong, China.
- Zheng, Changjun, Shumaila Meer Perhiar, Naeem Gul Gilal, and Faheem Gul Gilal. 2019. Loan loss provision and risk-taking behavior of commercial banks in Pakistan: A dynamic GMM approach. *Sustainability* 11: 5209. [CrossRef]



Article

# Analysis of Factors Influencing Credit Access of Vietnamese Informal Labors in the Time of COVID-19 Pandemic

Hung Van Vu <sup>1,\*</sup> and Huong Ho <sup>2</sup><sup>1</sup> Faculty of Political Theory, Thuongmai University, Hanoi 100000, Vietnam<sup>2</sup> Faculty of Politics, Vietnam Youth Academy, Hanoi 100000, Vietnam; hohuong112007@gmail.com

\* Correspondence: hungvvu@tmu.edu.vn

**Abstract:** Credit is considered as an essential tool to make informal labor's income better. In order to improve quality of their life, the state should have some supports them in credit access. This study analyzes factors causing credit access of informal labors to be changed in the time of COVID-19 pandemic. Using survey data collected from 2020 VHSSL (2019–2020), this approach has two models including a binary logit model and a multinomial logit model (MLM). The results revealed that the positive factors including education, material, collateral, credit size, credit source, credit debt which are likely to affect to credit access, however age, family size, ethnicity, interest, paid money are negative. Besides, it also concludes that quality of life of informal labor is considerably influenced by credit access, collateral, credit source, credit debt from the observed samples. Additionally, this paper recommends some policies to enhance informal labor's access to credit and their quality of life.

**Keywords:** urban; rural; informal labor; credit access; quality of life

**Citation:** Vu, Hung Van, and Huong Ho. 2022. Analysis of Factors Influencing Credit Access of Vietnamese Informal Labors in the Time of COVID-19 Pandemic. *Economies* 10: 8. <https://doi.org/10.3390/economies10010008>

Academic Editor: Ștefan Cristian Gherghina

Received: 23 September 2021

Accepted: 15 December 2021

Published: 27 December 2021

**Publisher's Note:** MDPI stays neutral with regard to jurisdictional claims in published maps and institutional affiliations.



**Copyright:** © 2021 by the authors. Licensee MDPI, Basel, Switzerland. This article is an open access article distributed under the terms and conditions of the Creative Commons Attribution (CC BY) license (<https://creativecommons.org/licenses/by/4.0/>).

## 1. Introduction

The global devastation caused by COVID-19 is only just beginning, with the severe threat to public health as well as having negative impacts on economies (Lee et al. 2021). Especially, the worst impacts are already being felt by informal labors, who face a dismal spectrum of probabilities of job losses, from diminishing sharply in earnings among the self-employed to job losses among paid labors (Rajneesh 2020). In Vietnam, the coronavirus (COVID-19) pandemic has significantly affected the economy and informal labors who are with little access to health and social security services. In general, average income of these labor decreased significantly, reaching to 25% in 2019 and 35.7% in 2020 (ILO 2020).

Credit access is an important component of the government's economic policy in almost nations. Many studies also show that credit access is one of the important factors affecting the informal sector in growth and development. The informal labors having accessibility of credit can invest and maximize their profit. Furthermore, credit improves productivity and raises living standards by breaking the vicious circle of poverty among informal labors (Li et al. 2011). Twumasi et al. (2020) confirmed that credit is an essential input for these labors because it enables them to enhance capital accumulation and can increase their income and savings as well as their ability to repay the loan. When informal labors can borrow loans, they will apply new technologies, improve productive activities, income and encourage them to intensify their participation (Nguyen et al. 2019). Therefore, credit is a powerful instrument for poverty reduction and improvement in the quality of life in informal labor sector.

In Vietnam, the government has given some support programs to help informal labors in both rural areas and urban areas to increase access ability and other financial services in order to overcome difficulties caused by the Covid 19 pandemic over the period of three years, starting form 2019. In general, the staged model applied for crisis management during the second and the third wave of COVID-19 in Vietnam has been successful (Da et al. 2021). In the 2000s, Vietnamese government has established some preferential credit funds for the

informal sector to improve informal workers on access to credit. However, many these labors are constrained and still excluded from access to credit. Many funds and formal banks are not willing to support them because they see these labors as a risky job (Pham 2020).

The main objective of this study is to analyze the factors influencing access to credit for informal labor sector in Viet Nam in the period of Covid 19 pandemic. More specifically, the paper determines the factors that affect their credit access including household characteristics (gender, age, education, ethnicity, family size, marital status, area, collateral, etc.) and credit characteristics (duration of credit, source of credit, political instability, size of credit, number of credits obtained, usage of the credit, savings, guarantees, interest . . . ). Furthermore, by comparing specific characteristics between the informal labors in rural and urban areas, the study analyzes and evaluates the impacts of credit access on improving quality of life for informal labors in the Time of COVID-19.

## 2. Literature Review

The most visible influence of the COVID-19 on world economy is to the unemployed, the self-employed, casual and gig-workers, small-scale entrepreneurs and businesses, which can be imperfectly described as those people and enterprises being in the informal sector. Informal includes individuals that might undertake piecework in their own premises, street vendors and most domestic workers. They lack of protection for non-payment of wages and retrenchment without notice, and often work under limited occupational safety conditions with no sick pay and health insurance (Sayed and Peng 2021).

In the developing countries, informal sector takes up a large proportion, with more than 2 billion people, representing 60% of workers and 80% of enterprises (ILO 2020). Overall, the COVID-19 crisis with the scale and rapid spread as well as large-scale lockdowns for a long time is a serious problem for the informal sector where poverty levels are high and already close the poverty line (Caiazza et al. 2021). Even if the pandemic subsides, we cannot expect things to return to their normal state in a medium run. In spite of having much talk about what policy actions less-developed countries can undertake to minimize the economic costs of the pandemic, in reality, few middle-income nations have the means to afford cautious and meaningful policy action (Rajneesh 2020). According to Hua and Shaw (2020), some countries are supplying tax relief measures and credit guarantees, but meaningful action needs constructive government organization to implement these measures.

Besides, many studies have discussed about factors that impede the farmer's access to agricultural credit. Most of these studies focus on agrarian credit borrowers. These researchers mostly draw their attention to household characteristics, asset ownership, regional characteristics (Kedir 2003; Ferede 2012) including factors as gender, age of the head of household, household size, membership in a financial solidarity group and socio-economic characteristics (Sekyi 2017).

Similarly, Twumasi et al. (2020) has shown that education, household size, association member, experience and region are variables affecting access to credit while Langat (2013) confirmed that access to credit depended on credit standards, assess return on credit, evaluate risk on loan to farm and transaction cost. In addition, size of credit, duration of credit, number of credits obtained, usage of the credit, savings, collateral security, interest rate also act as important components that influence access to credit (Bin 2021).

The following variables were tested based on the problem statement and relevant literature to know the statistical significance between farmers' access to credit and microfinance sources of capital (Agier and Szafarz 2013). Many factors inform the decision-making process by lenders of agricultural loans. These mechanisms are put in place by all microfinance institutions worldwide to tackle credit standards, assess return on credit, evaluate risk on loan to farm, and transaction cost (Langat 2013).

According to the conditions for credit access, the factors such as the type of financial organizations, policies are varieties used to determine access or not to credit (Sossou et al. 2017). The increase in individual credit may lead to customer selectivity basing on some main factors such as sufficient guarantees to obtain loans and a minimum collateral for loans.

In term of using models to examine the effect of credit access on producers, there are some types of models such as the linear regressive, binomial logit regression, probit model or logit models. [Lassana and Thione \(2020\)](#) used a binomial logit regression model to evaluate some main variables affecting cotton producers' access to credit. These variables are significant at the 5% level and impact on credit access are age, marital status and interest rate. Besides, other researchers have used the probit regressive model to examine factors influencing access to credit of a household. In particular, [Pham et al. \(2020\)](#) used this model to estimate factors having an influence to access formal credit of farmers in Soc Trang, Vietnam. They concluded that age, collateral for loans, and group membership can help improve their access to credit for rice farms.

Some studies have applied a multinomial logit model (MLM) was used to identify factors affecting the likelihood of a household being a non-borrower, a borrower with a preferential home loan or a borrower with commercial home loan ([Nguyen et al. 2018](#)). Moreover, a number of studies have used the MNL for estimating the likelihood of a housing borrowing loans from informal or formal credit sources ([Doan and Tuyen 2015](#)) or the probability of a small and middle-sized enterprise borrowing a formal or informal loan in Vietnam ([Nguyen and Luu 2013](#)). Besides, OLS model was specified to conclude that there were factors affecting to access to households and these factors were labors, the ratio of land value to total property value, the number of dependent members, the distance from home to place of loan ([Diagne 1999](#))

Furthermore, some papers have used the logistic model to analyze the determinants of credit by farmers ([Akudugu 2012](#); [Garay 2007](#)). [Nouman et al. \(2013\)](#) employed logistic regression to estimate the factors that influence the decision-making process by agricultural credit suppliers. They reviewed that the typical household characteristics that influence lenders' decision to grant household farmers' access to microfinance credit include social capital such as homogeneity, network connection, and socio-economic factors such as the farmers' income level, education, age, marital status, farming experience, farm size. When [Diagne \(1999\)](#) studied farm's access to credit in Malawi put the OLS model such as a tool to test factors having an influence on credit demand of farms. The factors affecting to credit demand included land, labors, farm size and location.

While [He and Li \(2005\)](#) have applied the probit model to show that education, age, income, savings and local policies are important factors affecting to access to credit of labors, [Anane et al. \(2021\)](#) notes that microfinance capital's source significantly influences farmers' access to credit through using logistic regression models. The analysis further revealed that land ownership, gender, and literacy strongly correlate with farmers' access to credit as well as establish that savings account, microfinance membership, and geographical location significantly influence the credit providers in decision-making process to grant a loan to the customer. His findings suggest that microfinance institutions have not been able to perform their business effectively because of capitalization. Similarly, [Bin \(2021\)](#) evaluates the major components of access to credit and their effects on the sustainability of SMEs in Cameroon by using the probit model and linear regression model with factors such as experience, interest rate, collateral security, corruption and size of loan.

[Assogba et al. \(2017\)](#) used the Logit model to conduct an analysis on the factors affecting farmers' access to credit. The model was specified to identify the relationships between access to credit and the socio-economic characteristics of the selected farmers including literacy (10.9%), years of schooling (3.9%), guarantor (18.9%), membership (31%), interest (11.7%) and collateral (12.4%). This study also recommended that governments should promote these factors to increase access to credit.

Besides these traditional models, some recent researches have used machine learning to utilize all data available and systematic models that are accurate, efficient, and objective. In term of credit scoring, [Kumar et al. \(2021\)](#) use systematic literature review methods to identify and compare the best fit AI-ML-based model adopted by various financial institutions worldwide. The main purpose of this study is to present the various ML algorithms highlighted by earlier researchers that could be fit for a credit assessment



of rural borrowers, particularly those who have no or inadequate loan history. Besides, in recent years, artificial intelligence (AI) techniques and machine learning have shown successful performance in credit scoring and credit access. This illustrates that machine learning derived model and artificial intelligence techniques can automatically adapt to changes in input data patterns—an infeasible task for a human analyst, especially when measured over long periods of time and big data which brings volumes and complexity of information (Adewumi and Akinyelu 2017; West 2000).

Overall, diverse determinants of credit access highlighted in the literature include household characteristics (gender, age, education, ethnicity, family size, marital status, area, collateral, etc.) and credit characteristics (duration of credit, source of credit, political instability, size of credit, number of credits obtained, usage of the credit, savings, guarantees, interest, etc.). Besides, many studies have used the linear regressive model to examine the impact of factors to access to credit in farmers, households and other labors (linear regressive, binomial logit regression, probit model, logit model, multinomial logit model . . . ). Although some of those studies did examine determinants of access to credit, not even one emphasized the credit access of informal labors especially in the Time of COVID-19.

### 3. Data and Methods

#### 3.1. Data

In this study, household data were taken from the Vietnam Household Living Standard Survey (VHLSS) of 2020. The VHLSS was conducted by the General Statistics Office of Vietnam (GSO) with technical assistance from the World Bank. We used data from the sample of households, including 4500 households in two years from 2019 to 2020. This time is the Covid period in Viet Nam so government applied some policies to help informal labors to overcome difficulties caused by the Covid pandemic. The VHLSS sample was selected in a way to represent the entire country at the national, regional, urban, rural and provincial levels. The VHLSS contained rich information about demographic characteristics, employment and economic sources, education, health, housing, durable assets and land. In particular, the data included detailed information about credit characteristics and access to credit, including formal sector and informal sector. According to Vietnamese labor code 2021, informal labor is a person who does not have a labor contract. So, from 4500 households, we only choose households having members who are informal labors and access to credit from preferential funds in two years of COVID-19 pandemic (from December 2019 to 2020). As a result, 577 informal labors in rural areas and 387 informal labors in urban areas were chosen to collect information on characteristics of the households and credit characteristics of the households.

#### 3.2. Methods

In this study, we also use binary logit model and multinomial logit model (MLM). First, we use binary logit model to show the factors that influence informal labor's access to credit. Next, we investigate the impact of credit access, among other factors related credit access on improving quality of life of informal labors in urban and rural areas in Vietnam. Second, we also apply the statistical analyses including descriptive statistics and multiple regression analysis. The factors were examined if they can associate with the credit access of informal labors to improve quality of life. In this study, we also investigate factors affecting the level of improvement of quality of life. Improving quality of life scores of respondents, taken from a multiple-choice question: "When you receive this credit loan, how is your quality of life improved?". The four possible responses to the question are "much of an improvement", "slight improvement", "no improvement", and "decrease". Thus, for our analysis, improving the quality of life is constructed with a value from 1 to 4, corresponding to level of improving quality of life.

The response variable (quality of life) is a polychotomous variable having four categories including much of an improvement, a slight improvement, no improvement and decrease. So we use a multinomial logit model (MLM) to identify factors affecting access to

credit to improve quality of life for the informal labors. Some studies have used the MNL for estimating the access to credit from other sources and the probability of access to homebuyer credit in urban Vietnam (Doan and Tuyen 2015; Nguyen et al. 2018). To estimate the impacts of access to homebuyer credit and housing satisfaction among households buying affordable apartments in urban Vietnam, Nguyen et al. (Nguyen et al. 2018) has applied descriptive statistics and multiple regression analysis including using a multinomial logit model (MLM) with three group factors (objective attributes of households and objective characteristic of the environment).

Let  $P_{ij}$  ( $j = 1, 2, 3, 4$ ) expresses the probability of being in a given borrowing group of a household.

$i$  with:  $j = 1$  if the household has much of an improvement,  $j = 2$  if the household has a slight improvement,  $j = 3$  if the household has no improvement and  $j = 4$  if the household has a decrease. Then, the multinomial logit model is given by

$$P_{ij}(j = kXi) = \frac{\exp(\beta kXi)}{\sum_{j=1}^4 \exp(\beta jXi)} (j = 1, 2, 3, 4) \tag{1}$$

In order to make the model identified,  $\beta_j$  is set to zero for one of the categories, and coefficients are then interpreted with respect to that category, called the reference or base category (Cameron and Trivedi 2005). Thus, set  $\beta_j$  to zero for one of four groups, then the MNL model for each group can be rewritten as:

$$P_{ij}(j = kXi) = \frac{\exp(\beta kXi)}{\sum_{j=1}^2 \exp(\beta jXi)} (j = 1, 2, 4) \text{ and } P_{ij}(j = 3Xi) = \frac{1}{\sum_{j=1}^4 \exp(\beta jXi)} (j = 1, 2, 3, 4) \tag{2}$$

which can be estimated using the method of maximum likelihood.

Table 1 describes the definition and measurements of variables included in the model of access to credit. The first group of variables is gender, age, education, family size, marital status, ethnicity, collateral. We use these variables in the analysis for the characteristics of informal labor, which is likely to enable them to meet requirements to credit access. The second group includes variables on credit source, credit size, paid money for using of credit, collateral. These factors might influence ability of access to credit of informal labors as well as quality of life improvement. Table 1 describes the definition and measurements of variables included in the model of access to credit.

**Table 1.** Definition of explanatory variables used in the regression model.

Variables	Definition
Dependent variables	
Access to credit	Access to credit (1 = yes, 0 = no)
Quality of life	Improving quality of life, 1 = much of an improvement, 2 = slight Improvement, 3 = no improvement, 4 = decrease
Explanatory variables	
Household characteristics	
Gender	Respondent gender (1 = male; 0 = female)
Age	Informal labor’s actual age (years)
Education	Actual schooling years
Ethnicity	Whether respondent is Kinh (1 = yes; 0 = no)
Family size	Number of household members (people)
Marital status	Get married (1 = married, 0 = otherwise)
Collateral	Have a collateral security (1 = yes, 0 = no)
Area	Live in urban and rural areas (1 = urban, 0 = rural)

Table 1. Cont.

Variables	Definition
Credit characteristics	
Source of credit	Organization supply (1 = banks, 2 = associations, 3 = local credit fun)
Size of credit	The amount of money borrowed
Credit debt	Unpaid credit loans (1 = if all loans have been paid, 0 = all loans have not been paid)
Paid money	A loan origination fee (million dong)
Interest	The interest rate charged to the borrower (%)

## 4. Results and Discussion

### 4.1. Descriptive Statistics and Findings

Table 2 provides some background information on household characteristics (such as age, gender, education, ethnicity, family size, marital status, collateral, area) and credit characteristics of respondents (informal labors). It shows that the age, education level, gender, family size and marital status are quite similar between two groups of informal labors. However, ethnic type between two groups is difference. The proportion of Kinh people in urban areas is much higher (0.91%) among those being other ethnicities (0.76%).

Table 2. Descriptive statistics of variables.

Variables	All		Urban		Rural	
	Mean/Share	SD	Mean/Share	SD	Mean/Share	SD
Dependent variables						
Access to credit	21.42%		23.57%		17.33%	
Quality of life						
Much of an improvement	36.83%		36.24%		36.22%	
Slight improvement	43.17%		45.30%		49.22%	
No improvement	10.37%		8.71%		7.97%	
Decrease	8.23%		9.76%		6.95%	
Explanatory variables						
Household characteristics						
Gender	51.92%		57.84%		55.29%	
Age	33.77	19.81	31.89	19.73	32.08	19.91
Ethnicity	81.83%		82.56%		76.78%	
Education	6.34	3.72	5.99	2.04	5.79	2.10
Family size	2.58	1.52	2.59	1.56	2.63	1.57
Marital status	69.40%		77.83%		74.34%	
Credit characteristics						
Collateral	29.82%		26.98%		33.56%	
Credit source	2.64	0.82	2.65	0.81	2.64	0.83
Banks	19.00%		18.60%		13.00%	
Associations	1.20%		0.70%		1.00%	
Local credit fun	76.00%		77.20%		81.00%	
Credit size	178,970.8	502,078.5	179,290.6	417,824.9	178,824.0	537,679.8
Credit debt	142,830.7	330,563.5	144,965.9	291,299.8	141,850.8	348,046.8
Paid money	84.74	559.21	149.25	843.93	55.13	360.86
Interest	2.95	4.15	2.44	3.53	3.19	4.41
Number of observation	963		577		387	

Source: authors' own calculation from the 2020 VHLSS.

As shown in Table 2, 33% of the rural informal labors borrowed loans with collateral and the figures are much higher (43%) for those in urban areas. On average, the mean value of credit size is 178,970.8 million VND for all areas, and slightly higher for those in urban areas (179,290.6 million VND) than those in rural areas (178,824.0 million VND). By

contrast, amount of paid money to having loans from urban informal labors is higher for those in rural areas (149.25 million VND and 55.13 million VND respectively). Regarding the characteristics of credit, the data in Table 2 also shows that credit source, interest is the same to 2 types of labors (2.65, 2.64 and 2.44, 3.19 respectively).

#### 4.2. Determinants of Access to Credit

Table 3 presents the results from the Logit regression. The results show that some explanatory variables are statistically significant at the 10% level or lower, with their signs as expected. Furthermore, the Pseudo-R<sup>2</sup> equal to 0.26 and is highly significant, suggesting that this model is globally significant (Louviere et al. 2002).

**Table 3.** Determinants of access to credit for informal labor.

Variables	All			Urban			Rural		
	Coefficient	SE	p-Value	Coefficient	SE	p-Value	Coefficient	SE	p-Value
Gender	−0.14	0.68	0.03	−0.07	0.06	0.02	0.04	0.78	0.00
Age	−0.01	0.02	0.00	−0.02	0.01	0.02	−0.01	0.03	0.07
Ethnicity	−1.63	0.69	0.01	−0.11	0.11	0.03	−1.20	0.76	0.03
Education	0.02	0.20	0.05	0.01	0.01	0.01	0.08	0.24	0.01
Family size	−0.27	0.33	0.03	−0.02	0.03	0.04	−0.05	0.34	0.01
Marital status	0.93	1.01	0.09	0.04	0.08	0.06	1.05	1.13	0.08
Collateral	1.96	0.98	0.05	0.01	0.08	0.00	1.88	1.20	0.05
Credit source	0.01	0.29	0.01	0.01	0.03	0.01	0.07	0.33	0.02
Credit size	8.67	4.88	0.01	3.93	4.03	0.03	9.30	6.99	0.00
Credit debt	0.01	7.34	0.08	5.65	6.32	0.07	0.01	9.10	0.05
Paid money	−0.01	0.01	0.00	−0.01	0.01	0.04	−0.01	0.01	0.02
Interest	−0.03	0.09	0.02	−0.01	0.01	0.01	−0.02	0.08	0.03
Constant	0.07	2.10	0.03	0.29	0.19	0.03	0.16	0.22	0.03
Number of observation			963			577			387

Source: authors' own calculation from the 2020 VHLSS.

Firstly, education, marital status has a positive impact on receiving the preferential credit in two groups. Education has a statistic meaning ( $p < 0.05$ ); an increase of one school year will raise ability to gain credit access 0.02 times and 0.08 times in urban and rural informal labors respectively and impact of education on access to credit for informal labors in urban areas is higher than these labors in rural areas because they depend completely on off—farm works which required more professional skill. These findings are similar to the studies of Anane et al. (2021) and Lassana and Thione (2020).

Besides, the results demonstrate that the Kinh are not more likely to have more loans than the other ethnic groups, who are hindered by barriers of language and cultural customs. The reason is that almost preferential loans are given for poor informal labors and minority ethnic so these labors can access more easily than other labors. The expansion of marital status, credit source, collateral will increase the ability for access to credit with 0.04, 0.01 and 0.01 respectively for urban informal labors and 1.05, 0.07 and 1.88 respectively for rural informal labors. There is a significant difference between collateral of informal labors in urban and in rural areas. The result evidences that collateral of informal labor in urban areas is more necessary than those in rural areas.

Paid money and interest have an impact on credit access. This might result from the fact that if informal labors have a good credit condition they will gain credit loans easily. Similarly, Pham et al. (2020) revealed that characteristic of credit influence positively to gain credit in inform labor group in Vietnam. Better these factors enable those to meet some required conditions of access to credit in both rural and urban areas. Besides, credit size, credit debt in urban and rural areas can have a positive impact on informal labors' credit access (see Table 3).

Regarding the access to credits, the results confirm that age, ethnicity, family size, paid money, interest are not related to the access to informal labor's credits. So the results might

recommend that there is no difference in access to credit among the surveyed labors in urban and rural areas. The finding is the same to [Nguyen and Luu \(2013\)](#).

4.3. Effects of Access to Credit on the Quality of Life Improvement

According to the Vietnam Household Living Standard Survey (VHLSS) of 2018 conducted by the General Statistics Office of Vietnam (GSO) with 4,500 households in two years (2017 and 2018), the number of informal labors received preferential credit was 545 labors including 181 urban informal labors and 364 rural informal labors. However, in the time of COVID-19 (2019–2020), these informal labors grew up to 946 informal labors including 577 informal labors in rural areas and 387 informal labors in urban areas in the Vietnam Household Living Standard Survey (VHLSS) of 2021.

According to credit structure of informal labors, the results show that the amount of loans is obtained mainly from local credit sources (77% in urban areas and 81% in rural areas). Meanwhile, these labors only receive credit support from policy banks with 19% in urban areas and 13% in rural areas (Figure 1). Only a few other loans are taken from associations and private individuals. The average amount of credit is 179.290 million VND and 178.824 million VND in urban and rural areas respectively.

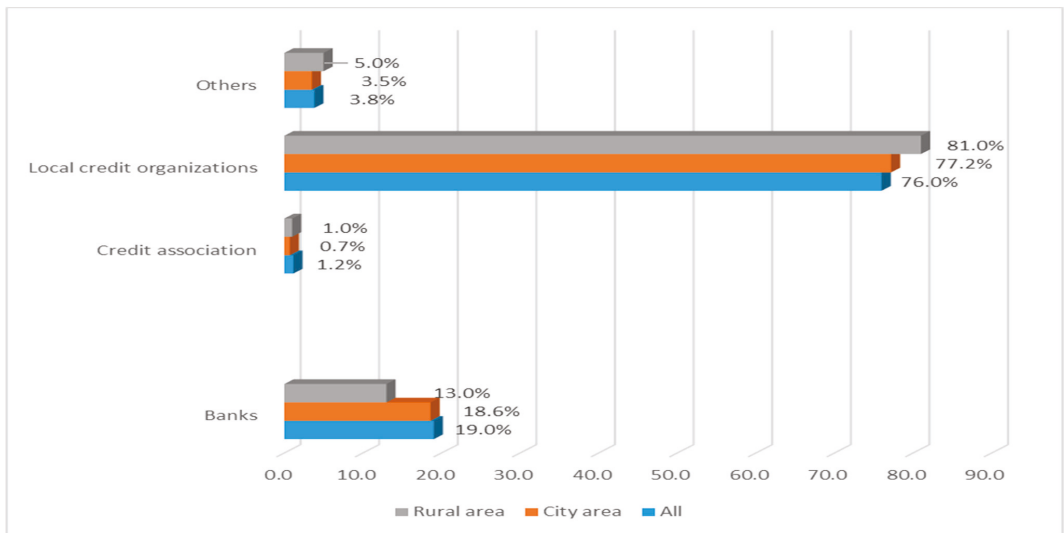


Figure 1. Structure of credit sources for informal labors in Vietnam. Source: authors’ own calculation from the 2020 VHLSS.

Table 4 presents the results of the MNL (Multinomial Logit) model on improving quality of life for informal labors. The variables, which are credit access, education, collateral, credit source, credit debt, interest have meaning in explaining the impact of credit access to improving quality of life for informal. In Table 4, test F of regressives has a meaning ( $p < 0.05$ ), which shows that there is no error in selection.

By access to credit, informal labors can increase the quality of life improvement; in particular, quality of life will raise by 0.21, 0.19 and 0.17 times in all areas, urban areas, rural areas respectively. Previous studies have echoed our conclusion on the role of credit access to informal labors. [Le and Pham \(2011\)](#) has proved access to credit and has increased income and quality of life for Vietnamese labors in informal sector. [Pham \(2020\)](#) has concluded that access to credit has positive impacts on reducing poverty and improving quality of life for rural labor in Vietnam.

**Table 4.** Effect of credit access on the quality of life improvement.

Variables	All			Urban			Rural		
	Coefficient	SE	<i>p</i> -Value	Coefficient	SE	<i>p</i> -Value	Coefficient	SE	<i>p</i> -Value
Credit access	0.21	0.24	0.00	0.19	0.17	0.04	0.17	0.15	0.01
Education	0.26	0.21	0.00	0.16	0.08	0.02	0.31	0.31	0.00
Collateral	0.31	0.79	0.00	0.29	0.46	0.01	1.17	3.01	0.02
Credit source	0.09	0.25	0.00	0.34	0.16	0.02	0.11	0.30	0.01
Credit size	3.12	2.44	0.03	1.25	2.22	0.01	4.24	4.73	0.07
Credit debt	8.50	7.10	0.00	−1.59	3.49	0/04	6.01	0.01	0.02
Paid money	−0.01	0.06	0.00	−0.01	0.01	0.04	−0.04	0.02	0.03
Interest	−0.25	0.14	0.00	−0.11	0.06	0.01	−0.20	0.24	0.05
Number of observation			963			577			387

Source: authors' own calculation from the 2020 VHLSS.

The other factors affected to quality of life improvement is education with the rate of 0.16 and 0.31 unit for urban and rural areas ( $p < 0.05$ ) and there is a slightly difference between two groups. Besides, it is also noted that greater life quality can result from some factors including credit source, credit size, credit debt, collateral. The finding indicates that these factors have a statistic meaning and influence positively to improving quality of life. However, credit debt variable is a discrepancy among all areas, urban areas and rural area with 8.50, −1.59 and 6.01 respectively. These labors in urban areas are often the priority people in the credit support policies, so they may receive these special loans without history of credit (Le and Pham 2011).

However, some factors have negative impacts on improving quality of life such as collateral, paid money, interest. According to the results of model, the rise of paid money and interest to have credit loans will lead to a decrease 0.01 and 0.25 times in quality of life for Vietnamese informal labors. This can be explained informal labors need preferential credit policies to improve credit access ability and to increase quality of life . . . .

## 5. Conclusions

In summary, as can be seen from the model's results, credit access plays an essential role in improving quality of life for informal labors. Therefore, credit access can be considered as a necessary determinant in the effort of poverty reduction and overcoming difficulties caused by COVID-19 pandemic in Vietnam. Besides, the positive factors including education, material, collateral, credit size, credit source, credit debt which are likely to affect to credit access, however, age, family size, ethnicity, interest, paid money are negative. Moreover, it also concludes that quality of life of informal labor is considerably influenced by credit access, collateral, credit source, credit debt.

This paper has examined what factors affecting access to credit and improving quality of life for informal labors by using two methods of a binary logit model and a multinomial logit model (MLM). The research findings including:

First, the results show that access to credit has a statistic significance and positive impact on improving in quality of life in all areas, urban and rural (0.21, 0.19 and 0.17 respectively). This finding supports the argument of Pham (2020) who suggested that the role of credit in improving living standards for labors in urban and rural areas. As a result, improving quality of life of informal labors based on credit access is no longer considered as a main solution in development strategies of Vietnam in the time of COVID-19.

Second, education of informal labors influence positively their credit access that measured in all areas. Moreover, by using MNL model, the results indicate that education is likely to generate the better quality of life for those are in the urban group. This finding suggests that education expands the inequality in Vietnam. As explained earlier, more effect of education on credit access and the improvement of quality life can be resulted from the fact that informal labors who are in urbans are more likely to be taken part in training courses.

Third, creditworthiness (credit debt) creates the highest positive impact on credit access and improvement of life quality. Creditworthiness is how a lender determines that you will default on your debt obligations, or how worthy you are to receive new credit. Creditworthiness is what creditors look at before they approve any new credit to borrowers. Creditworthiness is determined by several factors including repayment history and credit score. Some lending institutions also consider available assets and the number of liabilities borrowers have when they determine the probability of default. In this time of COVID-19 with economic crisis, bankrupt and unemployment can be one of the reasons makes this credit debt becomes more and more important. Therefore, there is a need to plan some policies to enhance creditworthiness of informal labors, for instance, supports for pay bills on time, keeping credit card balances, verifying debt to income . . . .

Fourth, the study also claims that some of factors relating to the credit characteristics such as credit size, collateral of informal labor in rural areas have a higher impact. The policy implies here is that if increase these factors for rural informal labors might be an effective solution to enable rural informal labors to improve quality of life and overcome difficulties caused by the COVID-19 pandemic.

These findings have implications to improve access to credit where the government can formulate an preferential policy for informal labors by increase the number of credit organizations and offer microcredit facilities that can access to loans at low interest rates as well as give some solutions to enhance the environmental optimizing laws, facilitating technology exchange and innovation, promoting awareness of these labor about their access credit conditions (collateral, paid money, credit debt . . . ). Additionally, the government can also set up an insurance mechanism for informal labors to cover unpaid debts and stabilize household income (main guarantee for informal labors' credit). Besides, informal labors need to improve their occupational skills which are a set of knowledge and skills that they need for a specific job at the onset of the COVID-19 economic crisis.

**Author Contributions:** Formal analysis, H.V.V. and H.H.; Investigation, H.V.V.; Methodology, H.H.; Project administration, H.V.V.; Writing—original draft, H.H.; Writing—review and editing, H.V.V., H.H. All authors have read and agreed to the published version of the manuscript.

**Funding:** This research received no external funding.

**Data Availability Statement:** Vietnam Household Living Standard Survey (VHLSS) of 2021 conducted by the General Statistics Office of Vietnam (GSO).

**Conflicts of Interest:** The authors declare no conflict of interest.

## References

- Adewumi, Aderemi, and Ayo Akinyelu. 2017. A survey of machine-learning and nature-inspired based credit card fraud detection techniques. *International Journal of System Assurance Engineering and Management* 8: 937–53. [\[CrossRef\]](#)
- Agier, Isabelle, and Ariane Szafarz. 2013. Subjectivity in credit allocation to microentrepreneurs: Evidence from Brazil. *Small Business Economics* 41: 263–75. [\[CrossRef\]](#)
- Akudugu, Mamudu. 2012. Estimation of the Determinants of Credit Demand by Farmers and Supply by Rural Banks in Ghana's Upper East Region. *Asian Journal of Agriculture and Rural Development* 2: 189–200.
- Anane, Isaac, Yue Zhang, and Fengying Nie. 2021. The Sources of Microfinance Capital and its Effects on Farmers access to Credit in Ghana. *SVU-International Journal of Agricultural Science* 3: 112–28. [\[CrossRef\]](#)
- Assogba, Perceval Noel, Sènakpon E. Haroll Kokoye, Rosaine N. Yegbemey, Jonas André Djenontin, Zacharie Tassou, Joanna Pardoe, and Jacob A. Yabi. 2017. Determinants of Credit Access by Smallholder Farmers in North-East Benin. *Journal of Development and Agricultural* 9: 210–16.
- Bin, Joachem Meh. 2021. Impact of Access to Credit on the Sustainability of Small and Medium Sized Enterprises in Cameroon. *American Journal of Industrial and Business Management* 11: 705–18. [\[CrossRef\]](#)
- Caiazza, Rosa, Erik Lehmann, and Henry Etkowitz. 2021. An absorptive capacity—Based system view of COVID-19 in the small business economy. *International Entrepreneurship and Management Journal* 17: 1419–39. [\[CrossRef\]](#)
- Cameron, A. Colin, and Pravin K. Trivedi. 2005. *Microeconometrics: Methods and Applications*. New York: Cambridge University Press.
- Da, Van Huynh, Thuy Thi Kim Truong, Long Hai Duong, Nhan Trong Nguyen, Giang Vu Huong Dao, and Canh Ngoc Dao. 2021. The COVID-19 Pandemic and Its Impacts on Tourism Business in a Developing City: Insight from Vietnam. *Economics* 9: 172. [\[CrossRef\]](#)

- Diagne, Aliou. 1999. *Determinants of Household Access to and Participation in Formal and Informal Credit Markets in Malawi*. Discussion Paper 67. Washington, DC: International Food Policy Research Institute.
- Doan, Tinh, and Tran Quang Tuyen. 2015. Credit participation and constraints of the poor in Peri-urban Areas, Vietnam: A micro-econometric analysis of a household survey. *Argumenta Oeconomica* 1: 175–200. [\[CrossRef\]](#)
- Ferede, Kiros Habtu. 2012. *Determinants of Rural Households Demand for and Access to Credit in Microfinance Institutions: The Case of Atamata Woreda—Ethiopia*. MA. Wageningen: Wageningen University Research.
- Garay, Annalyn Ramos. 2007. *Credit Accessibility of Smallscale Farmers and Fisherfolk in the Philippines. Review of Development and Cooperation*. Lincoln: University of Lincoln.
- He, Guangwen, and Lili Li. 2005. *People's Republic of China: Financial Demand Study of Farm Households in Longren/Guizhou of PRC*. ADB Technical Assistance Consult's Report. Project Number: 35412. Guiyang: ADB.
- Hua, Jinling, and Rajib Shaw. 2020. Corona Virus “infodemic” and emerging issues through a data lens: The case of china. *International Journal of Environmental Research and Public Health* 17: 2309. [\[CrossRef\]](#)
- ILO. 2020. *COVID-19 and the World of Work*, 5th ed. Geneva: International Labour Organization. [\[CrossRef\]](#)
- Kedir, Abi. 2003. *Determinants of Access to Credit and Loan Amount: Household—Level Evidence*. Urban Ethiopia' International Conference on Development Studies July 11–12, 2003, Addis Ababa, Ethiopia Paper 64. Kalamazoo: Western Michigan University.
- Kumar, Anil, Suneel Sharma, and Mehregan Mahdavi. 2021. Machine Learning (ML) Technologies for Digital Credit Scoring in Rural Finance: A Literature Review. *Risks* 9: 192. [\[CrossRef\]](#)
- Langat, Robert Cherutyot. 2013. *Determinants of Lending to Farmers by Commercial Banks in Kenya*. Nairobi: University of Nairobi.
- Lassana, Touré, and Diop Ibrahima Thione. 2020. Analysis of Determinants of Access to Credit for Cotton Producers in Mali. *South Asian Journal of Social Studies and Economics* 6: 44–59. [\[CrossRef\]](#)
- Le, Linh K., and Duong V. Pham. 2011. Analysis of factors determining the amount of formal credit loans of farm households in An Giang. *Banking Technology Magazine* 60: 8–15.
- Lee, Han-Sol, Ekaterina A. Degtereva, and Alexander M. Zobov. 2021. The Impact of the COVID-19 Pandemic on Cross-Border Mergers and Acquisitions' Determinants: New Empirical Evidence from Quasi-Poisson and Negative Binomial Regression Models. *Economies* 9: 184. [\[CrossRef\]](#)
- Li, Xia, Christopher Gan, and Baiding Hu. 2011. The welfare impact of microcredit on rural households in China. *Journal of Behavioral and Experimental Economics (formerly The Journal of Socio-Economics)* 40: 404–11. [\[CrossRef\]](#)
- Louviere, Jordan J., David A. Hensher, and Joffre D. Swait. 2002. *Stated Choice Methods: Analysis and Application*. Cambridge: Cambridge University Press, ISBN 0-521-78830-7.
- Nguyen, Anh Tuan, Tuyen Quang Tran, Huong Van Vu, and Dat Quoc Luu. 2018. Housing satisfaction and its correlates: A quantitative study among residents living in their own affordable apartments in urban Hanoi, Vietnam. *International Journal of Urban Sustainable Development* 10: 79–91. [\[CrossRef\]](#)
- Nguyen, Nhung, and Nhung Luu. 2013. Determinants of financing pattern and access to formal-informal credit: The case of small and medium sized enterprises in Viet Nam. *Journal of Management Research* 5: 240–59. [\[CrossRef\]](#)
- Nguyen, Ninh, Nguyen T. Phuong, and Nguyen P. Quan. 2019. Analysis of factors affecting the accessibility of official credit for households in Thua Thien Hue province. *Journal of Science and Development* 8: 844–52.
- Nouman, Muhammad, Muhammad Siddiqi, Syed Asim, and Zahid Hussain. 2013. Impact of Socio Economic Characteristics of Farmers on Access to Agricultural Credit. *Sarhad Journal of Agriculture* 29: 469–76.
- Pham, Binh, Anh Huynh, and Tran C. Tho. 2020. Factors affecting formal credit access of rice farmers in Nga Nam town, Soc Trang province. *Journal of Scientific Research and Economic Development* 8: 2020.
- Pham, Chuong Hong. 2020. *Evaluation of COVID-19 Response Policies and Recommendations*. Hanoi: National Economics University Publishing House.
- Rajneesh, Narula. 2020. Policy opportunities and challenges from the COVID-19 pandemic for economies with large informal sectors. *Journal of International Business Policy* 3: 302–10.
- Sayed, Adham, and Bing Peng. 2021. Pandemics and Income Inequality: A Historical Review. *SN Business & Economics* 1: 54.
- Sekyi, Samuel. 2017. Rural households' credit access and loan amount in Wa Municipality, Ghana. *International Journal of Economics and Financial Issues* 7: 506–14.
- Sossou, Comlan Hervé, Gildas Adjovi, Thomas Dogot, and Philippe Lebailly. 2017. *Analysis of the Determinants of Access to Credit for Agricultural Holdings in Benin*. Cotonou: National Institute of Agricultural Research of Benin (INRAB), p. 15.
- Twumasi, Martinson Ankrach, Yuansheng Jiang, and Monica Owusu Acheampong. 2020. Determinants of agriculture participation among tertiary institution youths in Ghana. *Journal of Agricultural Extension and Rural Development* 11: 56–66.
- Twumasi, Martinson Ankrach, Yuansheng Jiang, Evans B. Ntiamaoh, Selorm Akaba, Kwabena N. Darfor, and Linda K. Boateng. 2020. *Access to Credit and Farmland Abandonment Nexus: The Case of Rural Ghana*. Hoboken: Wiley. [\[CrossRef\]](#)
- West, David. 2000. Neural network credit scoring models. *Computers & Operations Research* 27: 1131–52.





## Article

# The COVID-19 Era—Influencers of Uneven Sector Performance: A Canadian Perspective

Vikram Singh <sup>1,\*</sup>, Homayoun Shirazi <sup>2</sup> and Jessica Turetken <sup>3</sup>

<sup>1</sup> Department of Global Management, Ted Rogers School of Management, Ryerson University, Toronto, ON M58 2K3, Canada

<sup>2</sup> Department of Economics, Ryerson University, Toronto, ON M58 2K3, Canada; homayoun.shirazi@ryerson.ca

<sup>3</sup> Ted Rogers School of Management, Ryerson University, Toronto, ON M58 2K3, Canada; jessica.turetken@ryerson.ca

\* Correspondence: vik.singh@ryerson.ca

**Abstract:** The study estimates the impact of COVID-19 on the labour market outcomes of major industrial sectors in Toronto, the largest urban centre in Canada. Using various economic data, we classify the sectors as distressed, stable, and those requiring ongoing monitoring. Furthermore, we estimate the expected impact of the pandemic shock using the Impulse Response Function (IRF) method. The results show an uneven impact of the pandemic with adverse outcomes for low-paying front-facing sectors, such as accommodation & food services and manufacturing. The post-pandemic projections show lingering negative implications for various sectors. The insights are helpful for policy recommendations, such as targeted responses to address the declines and structural changes in these sectors because of increasing technology adoption and the resulting labour market challenges.

**Keywords:** COVID-19; Canada; labour market; industrial sectors

**Citation:** Singh, Vikram, Homayoun Shirazi, and Jessica Turetken. 2022. The COVID-19 Era—Influencers of Uneven Sector Performance: A Canadian Perspective. *Economies* 10: 40. <https://doi.org/10.3390/economies10020040>

Academic Editor: Ștefan Cristian Gherghina

Received: 15 December 2021

Accepted: 25 January 2022

Published: 2 February 2022

**Publisher's Note:** MDPI stays neutral with regard to jurisdictional claims in published maps and institutional affiliations.



**Copyright:** © 2022 by the authors. Licensee MDPI, Basel, Switzerland. This article is an open access article distributed under the terms and conditions of the Creative Commons Attribution (CC BY) license (<https://creativecommons.org/licenses/by/4.0/>).

## 1. Introduction

The COVID-19 pandemic has profoundly affected the global economy along with causing grave implications for public health (Gormsen and Koijen 2020; Ingravallo 2020; Ozili and Arun 2020). The socio-economic impact has been uneven, as vulnerable segments of the population, such as racialised individuals, women, and those with less education, face the brunt of the pandemic (Milani 2021; Béland et al. 2020; Blundell et al. 2020; Gupta et al. 2020; Rojas et al. 2020; UN 2020; Yasenov 2020). Several key themes have emerged that guide our reflection and understanding of the impact of COVID-19 and the ability to predict future scenarios. Apart from the economic disruption and welfare losses resulting from adverse health outcomes, the pandemic has profoundly changed consumer behaviour. In the initial periods of the pandemic, consumers followed health concerns by changing the way they shopped, moving aggressively towards online shopping and limiting purchases that were considered essential (Andersen et al. 2020; Ceylan et al. 2020; Goolsbee and Syverson 2020). Several sectors of the economy, such as retail, hospitality, and travel & tourism, continue to experience significant disruptions, with the resulting organisational changes expected to last well beyond the pandemic. The effects of the pandemic are likely to shift the economic trajectory, with the recovery from the downturn being uneven. Many sectors will continue to struggle, while others will likely grow beyond pre-pandemic levels.

This study seeks to identify emerging trends that are likely to continue in the post-pandemic phase and transform the labour market and industrial sectors in Toronto, the largest urban centre in Canada. The research question we ask is: How has COVID-19 influenced the labour market of major sectors of the economy in Toronto? The motivation for this study stems from the unequal impact of the pandemic on the economy and its sectors. Addressing this question and identifying the potential causes of the differential effects of the pandemic on different sectors can help make predictions and, consequently,

policy suggestions for the post-pandemic period. We first estimate the impact of COVID-19 on the economy and the resulting labour market trends. Then, we analyse the top industry sectors, assessing the economic fallout due to the pandemic and provide forecasts of how they are likely to evolve in the post-pandemic economy. Our study offers several contributions. The findings can contribute to policymaking; the initial identification of industry and organisational trends can spark strategic conversations about potential interventions needed to change the current revenue tools and policy frameworks in the post-pandemic era. The study is structured as follows. Section 2 provides a brief literature review, while Section 3 explains the methodology. Section 4 presents the results, and Section 5 concludes with a discussion and conclusion.

## 2. Literature Review

The industrial transformations resulting from the pandemic come with an extensive list of inefficiencies and structural problems. Some sectors of the economy are likely to go through a labourious process of reassessing their core structures. Traditional industries will need to seek new operational frameworks to provide short-run confidence, including remote-work flexibility and the re-evaluation of key supply chains. Notably, while the pandemic has touched every industry, the challenges are not uniform. Studies in other jurisdictions show a profound impact on employment in specific sectors, such as accommodation and food services, retail, real estate, and other personal services (Svabova et al. 2020; Almeida and Santos 2020; Byrne et al. 2020; Bartik et al. 2020; Harris et al. 2020; Rapaccini et al. 2020). In Canada, the initial impact of the pandemic was severe, with a 32% decline in aggregate weekly hours for workers in the age category of 20–64, leading to an overall 15% decline in employment (Lemieux et al. 2020).

Deng et al. (2020) find that only 40% of employed Canadians have even a slight possibility of working remotely. However, despite the lack of agility to transform the workforce, the study finds observable changes in some industries, such as financial services, prevented a worst-case scenario for the Canadian labour market. Although there are considerable operational differences in the flexibility and ability of sectors to offer remote work, there are often overlooked aspects of industries, such as their ability to adapt quickly to the rethinking of the workplace during the pandemic. As Adams-Prassl et al. (2020) note, there is significant variability and heterogeneity within industries regarding employee ability to work remotely—the effect is comparatively more important than the observed differences in adaptability between sectors. For example, retail giants such as Walmart, Amazon, and Costco were financially and operationally insulated compared to their smaller competitors. While labour supply shifts beneath them, they can capitalise on the rest of the demand left in the wake of their smaller competitors, potentially going out of business because of the pandemic. Barrero et al. (2020) talk about this phenomenon and note that from March to May 2020, mega-businesses hired between three and four new employees for every ten layoffs in North America due to COVID-19. However, the pandemic has had a disproportionate impact on labour market outcomes on specific segments of the population, such as females (UN 2020), youth (Churchill 2021; Svabova and Kramarova 2021) and older individuals (Svabova and Gabrikova 2021) leading to societal inequalities.

Another significant theme evident during the pandemic is the increasing technology adoption in industries, also known as Industry 4.0.<sup>1</sup> According to Rymarczyk (2020), IR 4.0 refers to the prominence of a range of emerging technologies, including but not limited to big data, cloud computing, artificial intelligence, the internet of things, advanced machines, and blockchain. New technologies provided resiliency in supply chains and cost savings that were pivotal in the survival of many economic sectors.<sup>2</sup> While the mass replacement of labour due to automation sounds grim in an already damaged labour market, this situation does not have to be the ultimate fate of industries in a post-pandemic world. Shestakofsky (2017), who analysed 19 months of industry and technology co-evolution, observes a sharp shift to labour involving more computational and technological skills rather than full automation of work. Lichtenthaler and Fischbach (2019) recalls that the basis of technology

implementation is to move towards the ultimate goal of competitive advantage—while some artificial intelligence technologies can offer immediate operational benefits, there is a need to create a technologically positive infrastructure. While these studies put forward the changes in the industrial landscape, none provide a deeper understanding of how the pandemic changed the sectors, especially their labour market outcomes in Toronto. Our study fills this key literature gap.

### 3. Methodology

Our study seeks to identify and classify sectors based on their stability level to understand the impact of COVID-19 across sectors within Toronto. To that end, we use the following survey data: Canadian Labour Force Survey (LFS), Canadian Survey of Business Conditions (CSBC) and Longitudinal Employment Analysis Program (LEAP) from Statistics Canada. To forecast<sup>3</sup> the impact of COVID-19 on various sectors, we employ a  $4 \times 4$  VAR model<sup>4</sup>, which uses quarterly data from 2000q1 to 2020q3. Such a model permits the dynamics of shocks—impulse response functions (IRFs)—imposed by different variables on unemployment by sector. Due to data availability, the IRFs are estimated using provincial data. The VAR model includes seasonal dummies as exogenous variables to address seasonality. Cholesky ordering is used to estimate the impulse response functions (IRFs):<sup>5</sup>

$$Un_t = a_0 + \sum_{i=1}^k a_{1i} Un_{t-i} + \sum_{i=1}^k b_{1i} GDPSector_{t-i} + \sum_{i=1}^k c_{1i} GDPG_{t-i} + \sum_{i=1}^k d_{1i} Inf_{t-i} + \sum_{i=1}^3 f_{it} Dum_{it} + e_{1t} \quad (1)$$

$$GDPSector_t = b_0 + \sum_{i=1}^k a_{2i} Un_{t-i} + \sum_{i=1}^k b_{2i} GDPSector_{t-i} + \sum_{i=1}^k c_{2i} GDPG_{t-i} + \sum_{i=1}^k d_{2i} Inf_{t-i} + \sum_{i=1}^3 f_{it} Dum_{it} + e_{2t} \quad (2)$$

$$Inf_t = d_0 + \sum_{i=1}^k a_{4i} Un_{t-i} + \sum_{i=1}^k b_{4i} GDPSector_{t-i} + \sum_{i=1}^k c_{4i} GDPG_{t-i} + \sum_{i=1}^k d_{4i} Inf_{t-i} + \sum_{i=1}^3 f_{it} Dum_{it} + e_{4t} \quad (3)$$

$$GDPG_t = c_0 + \sum_{i=1}^k a_{3i} Un_{t-i} + \sum_{i=1}^k b_{3i} GDPSector_{t-i} + \sum_{i=1}^k c_{3i} GDPG_{t-i} + \sum_{i=1}^k d_{3i} Inf_{t-i} + \sum_{i=1}^3 f_{it} Dum_{it} + e_{3t} \quad (4)$$

where,  $Un_t$  denotes unemployment rate in each sector in Ontario;  $GDPSector_t$  represents the GDP growth rate of each sector;  $Inf_t$  indicates the aggregate inflation rate for Ontario;  $GDPG_t$  represents the growth rate of Ontario's economy,  $Dum_i$  denotes an exogenous seasonal dummy variable, and  $e_t$  is a random error with 0 mean and constant variance. The response from the shock is measured starting the first quarter of 2021, and the total period for the response is ten quarters. The GDP data are from the Ontario Ministry of Finance, and the unemployment rate is derived from Statistics Canada for the first quarter of 2000 to the third quarter of 2020. Please note that the employment data frequency is monthly, while the IRFs use quarterly periods.

We classify sectors according to the effects of COVID-19.<sup>6</sup> The top industries or sectors are identified according to the significance of their share of total employment in Toronto (Table 1) and classified according to the criteria listed in Table 2<sup>7</sup>. To identify sectors in the “distressed” category, we use two measures—an adverse change in year-over-year (2020–2019) employment along with eight or more month-to-month declines in employment (Table 2). Such sectors not only faced immense adverse effects during the pandemic, but are also likely to take the longest to recover in the post-pandemic period. Their recovery will likely require targeted assistance and a policy framework for structural reforms. Sectors classified as “must be monitored” are those with an adverse change in year-over-year employment (2020–2019) with a 3 to 8 month decline in employment. While not in crisis, these sectors will need ongoing monitoring and limited help to recover from the pandemic. Finally, those in the “stable” category experienced a positive change in employment over 2019–2020 and did not require targeted assistance.

**Table 1.** Top 10 sectors by employment (Toronto).

	2016	2017	2018	2019	2020
Professional, scientific and technical services	12%	13%	13%	13%	14%
Finance, insurance, real estate & leasing	12%	12%	11%	11%	12%
Healthcare & social assistance	11%	11%	11%	12%	12%
Retail trade	9%	10%	10%	9%	10%
Educational services	7%	6%	7%	8%	8%
Manufacturing	9%	8%	8%	8%	7%
Construction	6%	6%	6%	6%	6%
Accommodation & food services	7%	8%	7%	6%	5%
Transportation & warehousing	3%	4%	5%	5%	5%

Source: Labour Force Survey, Statistics Canada.

**Table 2.** Sector Classification criteria.

Category	Criteria
Distressed	Negative change in the year over year employment levels (2020–2019) and 8 or more negative monthly year over year (2020–2019) decline in employment
Must be monitored	Negative change in the year over year employment levels (2020–2019) and 3–8 negative monthly year over year (2020–2019) change in employment
Stable	Positive change in the year over year employment levels (2020–2019)

#### 4. Results

Table 3 illustrates the placement of the major sectors of Toronto’s economy in various categories based on the criteria listed in Table 1. Amongst all the sectors studied, the accommodation & food services and manufacturing sectors fared the worst, with losses of 31% and 10% in employment in 2020, respectively. Furthermore, they exhibited persistent negative sentiments—eight or more monthly employment declines—classified as “distressed.” The retail, transportation & warehousing, health care & social assistance, construction, and educational services sectors are placed in the “must-be monitored” category—despite an annual decline in employment in 2020, they show a revival in employment numbers towards the later part of the year. Last, the financial, insurance, real estate & leasing and professional, scientific & technical services sectors are classified as “stable” because of their robust employment structure and a positive year-over-year change in employment.

Table 3. Sector Classification.

	2016–2017	2017–2018	2018–2019	2019–2020	# of Months of Negative Change	Category	Negative IRF Periods (Quarters)	Is the Impulse Persistent?
	(1)	(2)	(3)	(4)	(5)	(6)	(7)	(8)
Accommodation & food services	14%	−8%	−9%	−31%	12	Distressed	5	No
Manufacturing	−8%	9%	−8%	−10%	8	Distressed	9	No
Retail trade	4%	7%	−8%	−6%	5	Must be monitored	8	No
Transportation & warehousing	20%	14%	16%	−19%	4	Must be monitored	3	No
Healthcare & social assistance	−1%	−0.4%	11%	−8%	4	Must be monitored	N/A	No
Construction	−1%	−3%	8%	−8%	3	Must be monitored	4	No
Educational services	−8%	10%	13%	−9%	3	Must be monitored	6	No
Finance, insurance, real estate & leasing	−4%	−7%	7%	2%	1	Stable	9	No
Professional, scientific & technical services	5%	4%	2%	1%	1	Stable	5	No

Notes: (1) Columns 1 to 4 depict the annual year-over-year change in employment. (2) Column 5 depicts the number of months of negative employment change in 2020. (3) Column 6 depicts the category where the sector falls using the criteria listed in Table 1. (4) Column 7 depicts the number of negative quarters of response to the COVID-19 shock starting after the first quarter of 2021, using the Impulse Response Functions (IRF). Due to lack of data, IRF is not estimated for the healthcare & social assistance sector. Provincial data is used to estimate the IRFs. (5) Column 8 indicates if the response from the COVID-19 was persistent (remained negative) over the ten quarters starting from the first quarter of 2021.

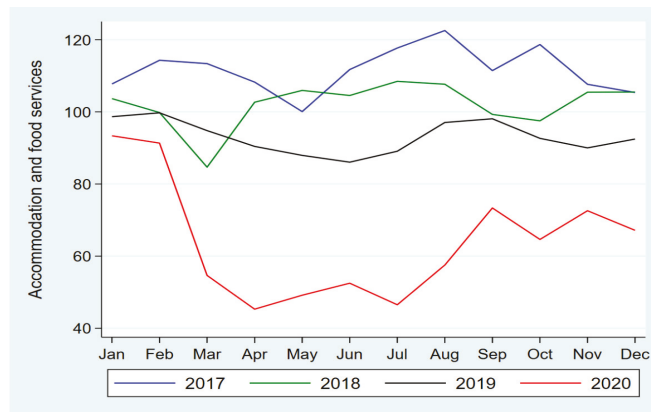
#### 4.1. Distressed Sectors

##### 4.1.1. Accommodation & Food Services

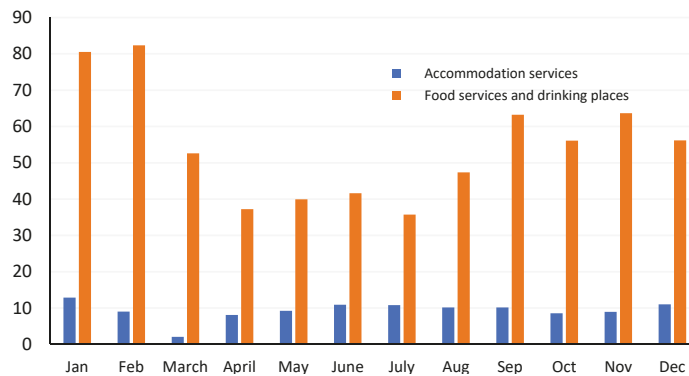
This sector comprises establishments primarily engaged in providing short-term lodging and the preparation and sale of food.<sup>8</sup> The COVID-19 restrictions around dining and the restrictions and fears around travel heavily impacted this sector, with most of the workforce unable to pivot to remote work—only 7% of the workforce transformed to remote work due to the pandemic (Table 3). The demographics of employees tend to be less educated and likely to be youth because of the flexibility in scheduling—approximately 62% were between the ages of 15–24 and working part-time.<sup>9</sup> Likewise, the average hourly wage in this sector was in the lower quartile compared to other industries—the provincial average salary was \$17.07 in 2020, the lowest compared to other sectors.<sup>10</sup> More businesses closing than opening also depict sectoral weakness—in 2020, there was a net loss of 1327 businesses in this sector in Toronto (Figure A2, Appendix A). Business closing as a percentage of active businesses was 8%, almost double the rates in the previous two years (Table A1, Appendix A).

Employment in this sector declined by 31% in 2020 compared to the previous year—the largest drop among all major sectors (Table 2). This sector was especially vulnerable because of the weakness in job numbers before the pandemic. Employment trended down, with declines of 8% and 9% in 2017–2018 and 2018–2019, respectively. Trends in 2020 show that employment in all months was lower than in similar months in the previous three years due to the onset of COVID-19 and the early lockdown (Figure 1). Employment fell by 40% in March, the highest among all major sectors, and by another 17% in April. With the reopening in July, the number rose again, with a peak in September of 73,000, but fell again in October and December because of the lockdown in response to the pandemic's second wave. Overall, this sector lost 349,000 jobs in 2020, ranking the most impacted by

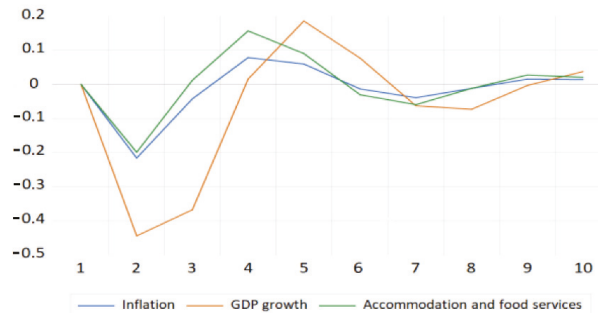
the pandemic, led by losses in its largest subsector—food services and drinking places (Figure 2). A shift in retail spending on food expenditure from restaurants to home cooking was likely a contributor to the pain experienced by this sector (Goddard 2020). The IRF forecast starting the first quarter of 2021 shows that a negative shock is likely to increase unemployment for five quarters (Figure 3 and Table A2, Appendix A). However, the future is expected to be volatile, with a recovery from a decline in employment expected only in the ninth quarter. Other countries such as Slovakia (Svabova et al. 2020), Portugal (Almeida and Santos 2020), Ireland (Byrne et al. 2020) and the US (Bartik et al. 2020) also reported a rapid decline in employment in this sector due to the pandemic.



**Figure 1.** Employment in the Accommodation and Food Services sector. The employment in all months in 2020 was lower than the corresponding months in previous years. The y-axis of the figures represents the number of employees in 1000s. Source: Labour Force Survey, Statistics Canada.



**Figure 2.** Accommodation and Food Services—employment in key segments, (2020). Employment in food services & drinking places struggled to recover in the post-pandemic period compared to accommodation services. The y-axis of the figures represents the number of employees in 1000s. Source: Labour Force Survey, Statistics Canada.



**Figure 3.** Accommodation and Food Services—IRF<sup>11</sup>. The figure depicts the impact of inflation, GDP growth for Ontario, and GDP in the accommodation and food services sector on unemployment in the sector, starting the first quarter of 2021. The effect (response) of the shock (COVID-19) was negative in the fourth and fifth quarters and did not entirely dissipate until the ninth quarter.

#### 4.1.2. Manufacturing

The manufacturing sector comprises establishments primarily engaged in the chemical, mechanical or physical transformation of materials or substances into new products.<sup>12</sup> The trends in this sector were closely related to the shutdowns in the spring and early summer of 2020—four-fifths of manufacturers in Toronto reported a negative impact of COVID-19 on their operations.<sup>13</sup> At the onset of the pandemic restrictions, the yearly month-over-month drop in manufacturing sales was 40% (Table 4). While a rebound took place in the subsequent months, the year ended with a decline in the remaining year. The pandemic took a toll on enterprise viability in this sector, with 3472 businesses opening and 4036 closings, with the bulk of the shutdowns occurring from March to July (Figure A2, Appendix A).

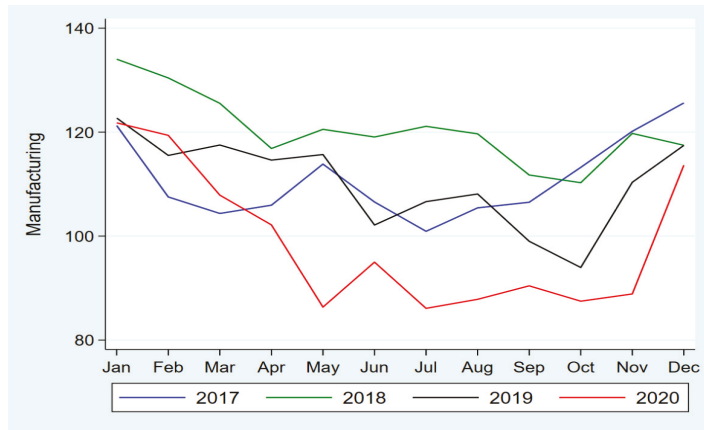
**Table 4.** Manufacturing sales.

	January	February	March	April	May	June	July	August	September	October	November	December
Month to month change	−2%	4%	0%	−40%	19%	41%	1%	0%	8%	−1%	0%	−9%
Year over year change	−7%	1%	−11%	−43%	−39%	−9%	1%	−7%	2%	−5%	−1%	1%

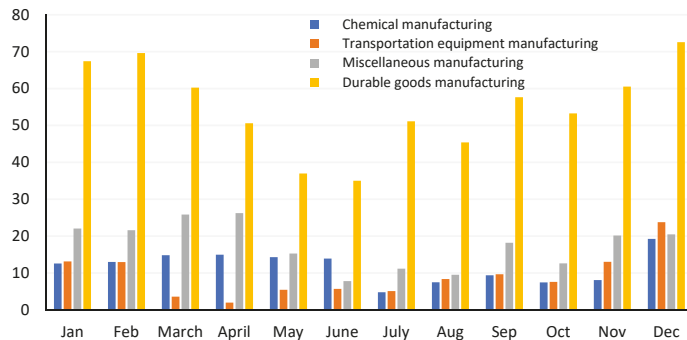
Source: Monthly Survey of Manufacturing, Statistics Canada.

This sector accounted for 7% of total employment in 2020, down from 8% in the previous year (Table 3). The weakness in manufacturing sales also translated into a depressed job market in 2020, with a loss of 8% compared to the previous year (Table 2). Employment fell to a low of 86,100 in July, with a slight rebound in the subsequent months due to the economy’s reopening (Figure 4). A drill-down of the key subsectors indicates that employment in durable goods manufacturing fared better because of the surge in online shopping (Figure 5). Despite this, the monthly employment numbers remained lower than those in the previous three years (Figure 4). The inability of most of the jobs in this sector to transition to remote work hampered the employment market—only 10% of the workforce could transition to remote work (Figure A1, Appendix A). The IRF forecast shows that the negative shock is likely to increase unemployment for at least nine quarters (Figure 6 and Table A2, Appendix A). Other countries, such as the UK (Harris et al. 2020) and Italy (Rapaccini et al. 2020), also face rapid declines in their manufacturing sector.

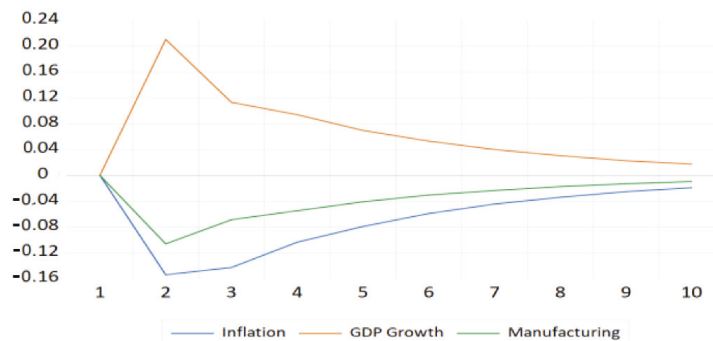




**Figure 4.** Employment in Manufacturing sector. The employment in all months post-March 2020, the start of the pandemic, was lower than the corresponding months in previous years. The y-axis of the figures represents the number of employees in 1000s. Source: Labour Force Survey, Statistics Canada.



**Figure 5.** Manufacturing—employment in key segments, 2020. The y-axis of the figures represents the number of employees in 1000s. Source: Labour Force Survey, Statistics Canada.



**Figure 6.** Manufacturing—IRF<sup>14</sup>. The figure depicts the impact of inflation, GDP growth for Ontario, and GDP in the manufacturing sector on unemployment in the sector, starting the first quarter of 2021. The effect (response) of the shock (COVID-19) beginning in 2021 is positive for the first three quarters, but shows increasing weakness and converges over time.

4.2. Must Be Monitored Sectors

4.2.1. Retail Trade

The retail sector comprises of firms engaged in retailing merchandise, generally without transformation, and rendering services related to merchandise sales.<sup>15</sup> It was the fourth largest sector in Toronto in terms of employment, accounting for 10% of the total workforce (Table 3). The pandemic shutdown immediately impacted retail sales, resulting in a plunge of 40% in April 2020 (Table 5). The front-line facing nature of much of the employment in this sector meant that only 12% of the workforce could transition to remote work (Figure A1, Appendix A). While sales rebounded strongly in the following months, a second COVID-19 wave led to a further decline during the important holiday season in December. The number of businesses that closed as a percentage of active businesses was 7% in 2020 compared to the average of 4% in the previous two years, highlighting the weakness in this sector (Table A1, Appendix A). More businesses closed (9728) than opened (8620) owing to many closings during April, May and June (Figure A2, Appendix A).

Table 5. Retail sales in 2020.

	January	February	March	April	May	June	July	August	September	October	November	December
Month to month change	-2%	4%	0%	-40%	19%	41%	1%	0%	8%	-1%	0%	-9%
Year over year change	-7%	1%	-11%	-43%	-39%	-9%	1%	-7%	2%	-5%	-1%	1%

Source: Survey of Retail Trade, Statistics, Canada.

The employment market also mimicked the sales drop in April; however, the numbers rebounded in the subsequent months, ending 2020 with an annual decline of only 6% from the previous year (Figure 7 and Table 2). Interestingly, the employment trend shows that December 2020’s monthly employment figure was higher than the previous three years. The robust rebound in employment was because of the increase in online retail sales.<sup>16</sup> Monthly employment at the end of 2020 outpaced that of 2017–2019 due to a rise in consumer purchases in response to travel and leisure restrictions.<sup>17</sup> An analysis of major retail subsectors finds a robust increase in employment in food & beverage as well as store retailer segments of this sector (Figure 8). The impulse response to the COVID-19 shock illustrates a persistent negative trend for the next eight quarters, highlighting the vulnerability to lockdowns and changing consumer shopping behaviour (Figure 9 and Table A2, Appendix A).

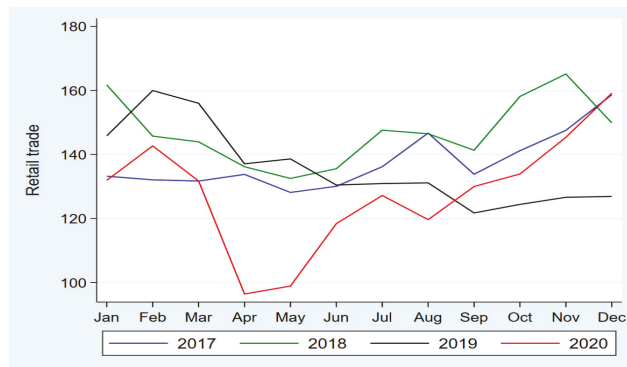
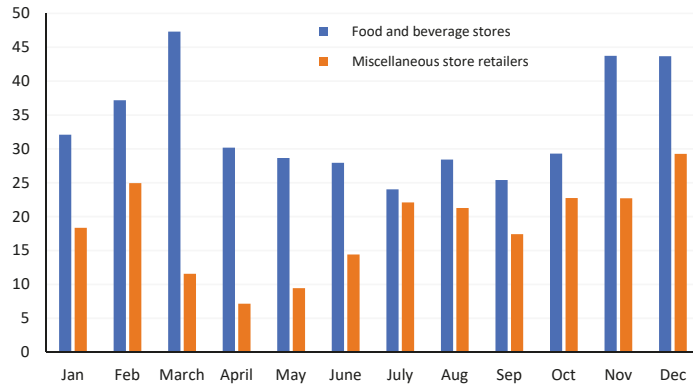
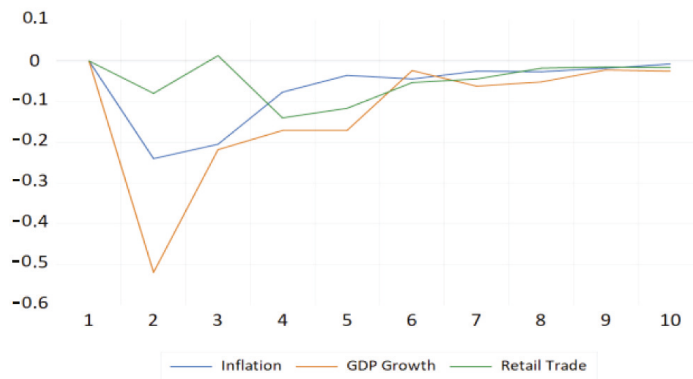


Figure 7. Employment in the Retail Trade sector. The employment in months after the pandemic in 2020 declined rapidly, but bounced back starting August. The y-axis of the figures represents the number of employees in 1000s. Source: Labour Force Survey, Statistics Canada.



**Figure 8.** Retail Trade sector—employment in key segments, 2020. Unlike miscellaneous store retailers, employment in the food and beverage stores segment remained lower in the period after the start of the pandemic. The y-axis of the figures represents the number of employees in 1000s. Source: Labour Force Survey, Statistics Canada.



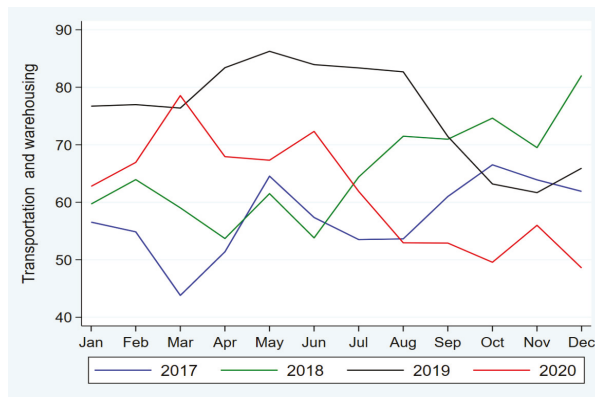
**Figure 9.** Retail Trade—IRF<sup>18</sup>. The figure depicts the impact of inflation, GDP growth for Ontario, and GDP in the retail trade sector on unemployment in the sector, starting the first quarter of 2021. The IRF shows a persistent negative trend that dissipates in the tenth quarter with the convergence.

#### 4.2.2. Transportation and Warehousing

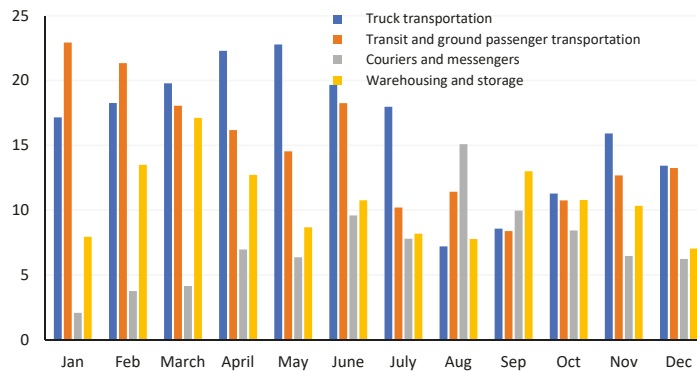
This sector includes organisations primarily engaged in transporting passengers and goods, warehousing and storing goods.<sup>19</sup> It employed 5% of the workforce in Toronto in 2020 (Table 3), including many essential workers.<sup>20</sup> While employment in the warehousing segment increased because of the dependence on online shopping and people working from home, the transport segment suffered considerable losses owing to the pandemic.<sup>21</sup> Transit usage in Toronto dropped by 21% since the pandemic’s onset due to work-from-home orders and fears associated with public transport (Habib et al. 2021). The rising virus cases in the TTC further depressed transit ridership.<sup>22</sup> Federal and provincial travel bans also affected the industry, with air travel and other tourism-related travels falling significantly during the pandemic.<sup>23</sup> Likewise, business travel decreased owing to many workplace restrictions, leading to a decline in travel revenues (Lundy 2021). The percentage of businesses closing out of the total active businesses was 9% in 2020, the highest among all the major sectors and exceeding the rates of 8% in the previous two years (Table A1,

Appendix A)—net business closures amounted to 977, the third most impacted sector in Toronto.

The employment trends during 2020 indicate a moderate decline in the initial months of the pandemic. Nevertheless, the situation in the subsequent months changed with a significant loss of 10,000 jobs in July (Figure 10). Monthly employment trends also remained lower than in previous years, starting in August. The transit & ground transportation sub-sector experienced a sharp decline in employment mitigated by the revival in employment in truck transportation (Figure 11). The year ended with a 19% drop in employment, the second-largest decline amongst all sectors (Table 2). The IRF forecast for the sector’s GDP shows that the initial negative impact of COVID-19 occurs in the second quarter of 2021 (Figure 12 and Table A2, Appendix A). Further declines occur in the sixth and seventh quarters, tapering off in the ninth quarter.



**Figure 10.** Employment in Transportation and Warehousing sector. While employment after the start of the pandemic in 2020 did not decline immediately, a rapid decline occurred from June, with the monthly levels starting in August being lower than those in the corresponding months in previous years. The y-axis of the figures represents the number of employees in 1000s. Source: Labour Force Survey, Statistics Canada.



**Figure 11.** Transportation and Warehousing sector—employment in key segments, 2020. The y-axis of the figures represents the number of employees in 1000s. Source: Labour Force Survey, Statistics Canada.

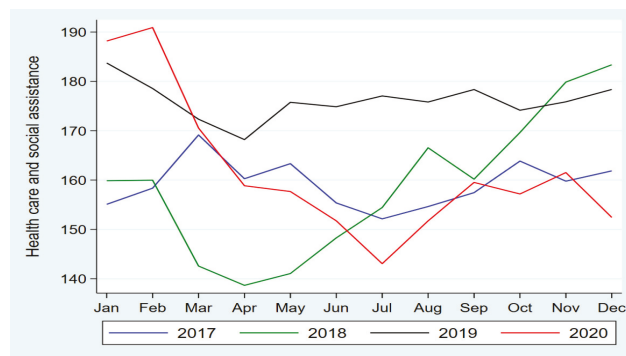


**Figure 12.** Transportation and Warehousing sector—IRF<sup>24</sup>. The figure depicts the impact of inflation, GDP growth for Ontario, and GDP in the transportation and warehousing sector on the sector unemployment, starting the first quarter of 2021. The negative shock lasts for two quarters, further declining in the sixth and seventh quarters and dissipates at the end of the ninth quarter.

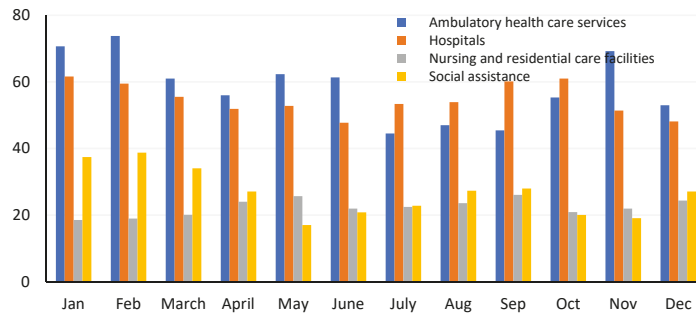
#### 4.2.3. Healthcare and Social Assistance

This sector consists of establishments primarily providing health care by diagnosis, treatment and social assistance, such as counselling, child protection, community housing and food services.<sup>25</sup> It is the third-largest sector in Toronto, accounting for 12% of total employment (Table 3); it reported an 8% decline in job numbers in 2020 (Table 2). Even though business closures exceeded business openings, the net closures (178) were lower than those in other sectors (Figure A2, Appendix A). The sector was shielded from massive layoffs, as experienced in other sectors, as many workers were classified as essential and benefited from being in the higher quantile of employment wages (Tal 2021).

The drop in employment mainly occurred from April to July, resulting from the COVID-19 lockdowns and the layoffs of registered nurses and administrative staff stemming from budgetary cuts of the province (Figure 13). However, there was an uptick in employment, especially in ambulatory health care and hospitals, because the provincial government added resources to address the critical health care needs related to virus transmission (Figure 14). After July, the revival in employment provided a respite, although the numbers failed to match the pre-pandemic levels.



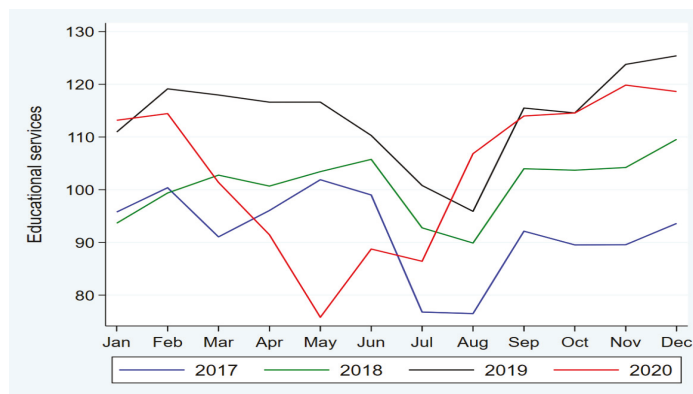
**Figure 13.** Employment in Healthcare and Social Services sector. The employment dropped at the start of COVID-19; however, a revival is noted starting July due to increased levels of government funding to mitigate the impact of the pandemic. The y-axis of the figures represents the number of employees in 1000s. Source: Labour Force Survey, Statistics Canada.



**Figure 14.** Healthcare and Social Services sector—employment in key segments, 2020. The y-axis of the figures represents the number of employees in 1000s. Source: Labour Force Survey, Statistics Canada.

#### 4.2.4. Educational Services

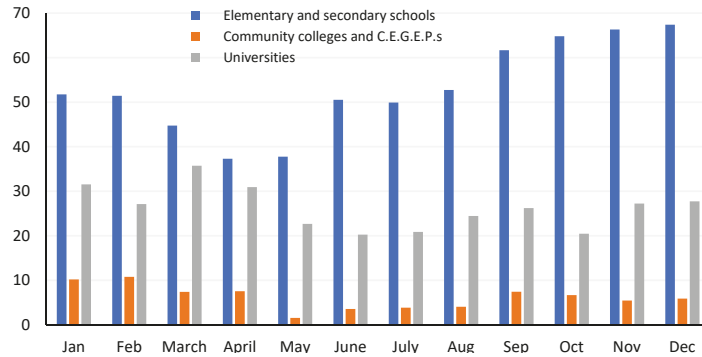
Educational services, including colleges, universities, and training centres engaged in providing instruction and training in various subjects<sup>26</sup>, and employed 8% of the total workforce in Toronto in 2020 (Table 3). This sector was relatively unscathed by business closings, with a net closing of 149 in 2020, the lowest among the city’s top sectors (Figure A2, Appendix A). However, it was impacted by the pandemic shutdown and transition to online learning as employment fell by 9% in 2020 (Table 2), with sharp declines during February, March, April and May (Figure 15). Even before the pandemic, employment in this sector had been reeling from provincial cutbacks and labour disputes in elementary, secondary, and postsecondary institutions.<sup>27</sup>



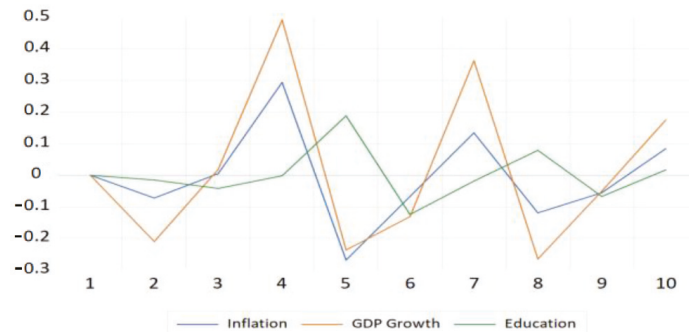
**Figure 15.** Employment in Educational Services sector. While the start of the pandemic led to a rapid decline in employment in April and May, the levels recovered due to the reopening of schools and added funding to meet online learning requirements. The y-axis of the figures represents the number of employees in 1000s. Source: Labour Force Survey, Statistics Canada.

The growth in employment in August 2020 was likely related to the provincial government’s efforts to increase headcounts to facilitate smaller class sizes and online education to aid with COVID-19 safety regulations.<sup>28</sup> Most of the additional jobs were in elementary & secondary schools, while community colleges & universities sub-sector ended the year at a net loss in employment (Figure 16). However, the impulse response from the shocks from the pandemic shows six quarters of expected adverse reactions (Figure 17 and Table A2,

Appendix A). Despite a respite in the fifth quarter, further declines occurred in the next three quarters.



**Figure 16.** Educational Services—employment in key segments, 2020. A strong increase in employment is reported for elementary & secondary schools. The y-axis of the figures represents the number of employees in 1000s. Source: Labour Force Survey, Statistics Canada.

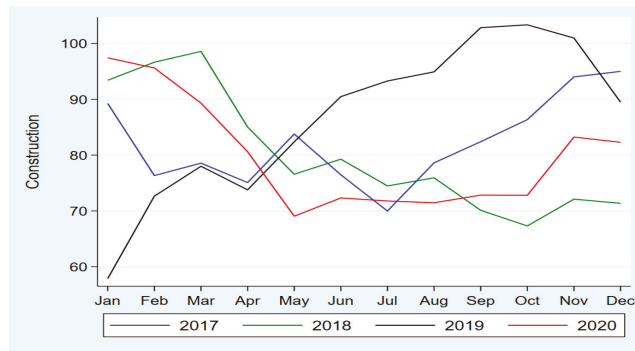


**Figure 17.** Educational Services—IRF<sup>29</sup>. The figure depicts the impact of inflation, GDP growth for Ontario, and GDP in the education sector on unemployment in the sector, starting the first quarter of 2021. The response to the shocks reports volatility, particularly negative trends, until the fourth period, and despite a respite in the fifth period, further declines in periods six, seven and nine.

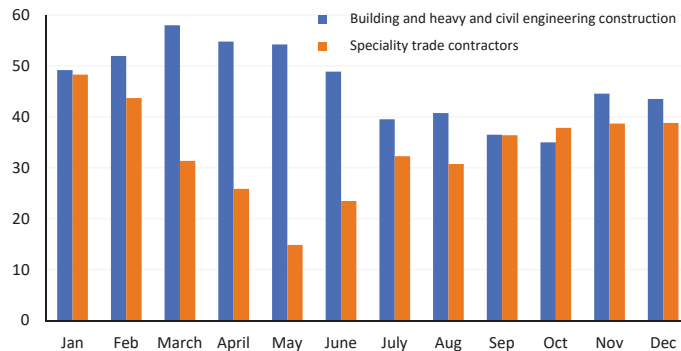
#### 4.2.5. Construction

The construction sector includes establishments primarily engaged in constructing, repairing, renovating buildings, engineering, subdividing and developing land.<sup>30</sup> The sector accounted for 6% of employment in Toronto in 2020, the proportion that remained stable despite the pandemic contractions (Table 3). Significant business closures occurred in 2020, especially during April, May and June, during which business closings as a percentage of active businesses jumped to 18%, 13% and 9%, respectively (Table A1, Appendix A).

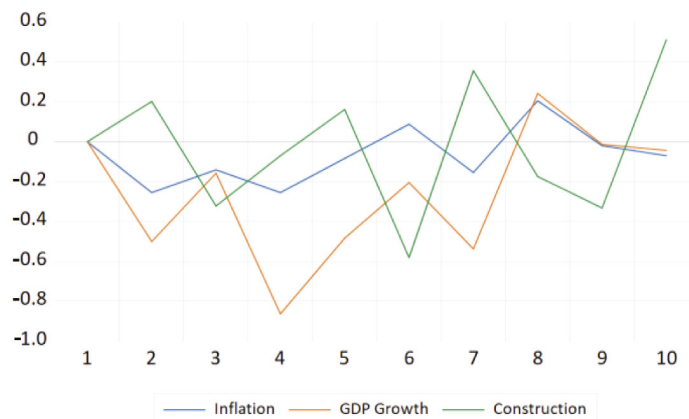
This sector employed approximately 97,430 individuals in 2020. However, a sharp decline followed the COVID-19 closures, with job losses concentrated in April (−10%) and May (−14%) (Figure 18). The losses were much more profound in the specialty trade subsector that bore the brunt of the crisis due to households delaying construction projects out of the fear of virus transmission and social distancing rules (Figure 19). The year ended with a net loss of 81,000 jobs in this sector or a decline of 8% from 2019 (Table 2). The IRF shows a lag in the pandemic’s shock, with five negative quarters (Figure 20 and Table A2, Appendix A).



**Figure 18.** Employment in Construction sector. The employment in this sector stabilised towards the end of 2020, despite the decline in the initial period of the start of the pandemic. The y-axis of the figures represents the number of employees in 1000s. Source: Labour Force Survey, Statistics Canada.



**Figure 19.** Construction—employment in key segments, 2020. The y-axis of the figures represents the number of employees in 1000s. Source: Labour Force Survey, Statistics Canada.



**Figure 20.** Construction—IRF<sup>31</sup>. The figure depicts the impact of inflation, GDP growth for Ontario, and GDP in the construction sector on unemployment in the sector, starting the first quarter of 2021. A lag in the pandemic’s shock occurs with declines in employment in the third period and volatility in the proceeding periods.



4.3. Stable Sectors

4.3.1. Professional, Scientific and Technical Services

This sector comprises establishments primarily engaged in activities in which human capital is the major input.<sup>32</sup> It was the largest sector in Toronto in terms of employment, with a share of 14% of total jobs in 2020 (Table 3). It employed 200,012 workers at the start of the year, which fell to 69,056 in June and then climbed to 221,073, ending the year with a net annual increase of 1% (Table 2). The yearly employment exceeded the previous three years, substantiating this sector’s strength (Figure 21). A likely reason for strength was that this sector comprises higher-paying legal, accounting, engineering, and other technical jobs. The ability to pivot towards virtual work was also a critical factor in the workforce’s stability—approximately 45% of this sector could transition to virtual work, the highest among all sectors due to the pandemic (Figure A1, Appendix A). Even though the IRF estimate shows an increase in unemployment in the initial five quarters, convergence to a transitory trend occurs in the seventh quarter (Figure 22 and Table A2, Appendix A).

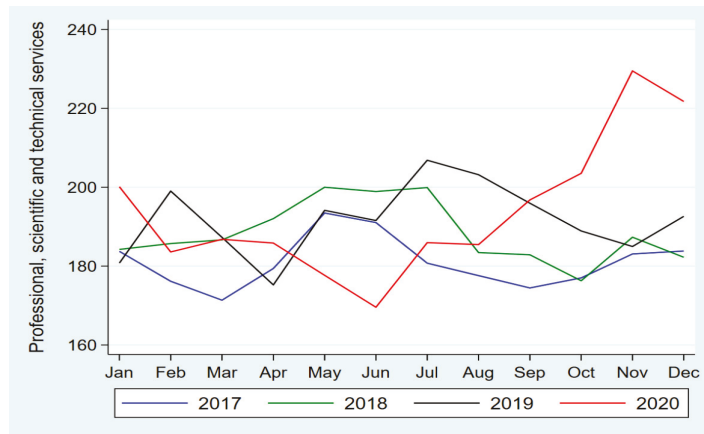


Figure 21. Employment in Professional, Scientific and Technical sector. The pandemic did not impact employment in this sector because of the transition to virtual work. The y-axis of the figures represents the number of employees in 1000s. Source: Labour Force Survey, Statistics Canada.

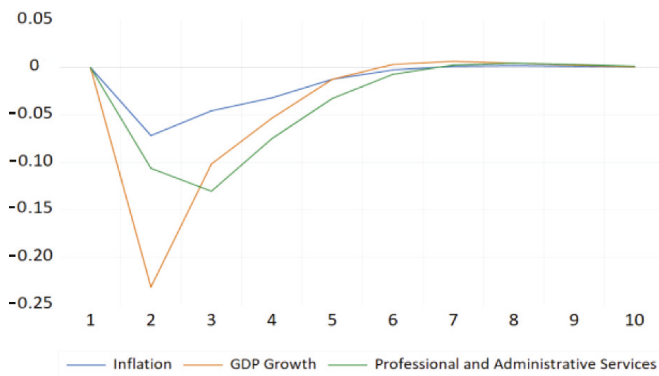
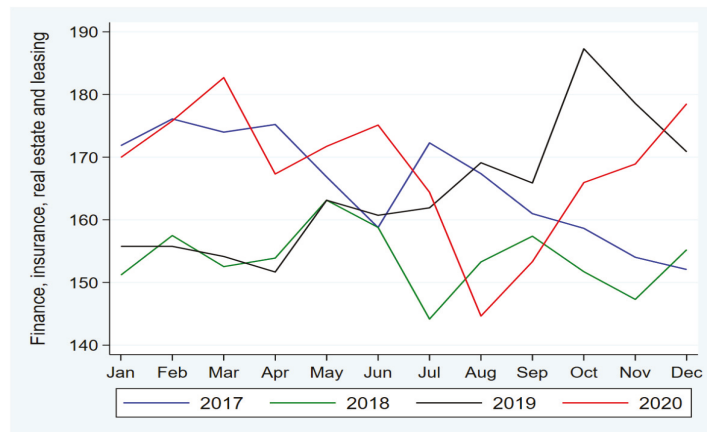


Figure 22. Professional, Scientific and Technical sector—IRF<sup>33</sup>. The figure depicts the impact of inflation, GDP growth for Ontario, and GDP in the professional, scientific & technical sector, starting the first quarter of 2021. Even though the IRF shows a drop in employment to the pandemic shock, convergence to a transitory trend occurs in the seventh period.

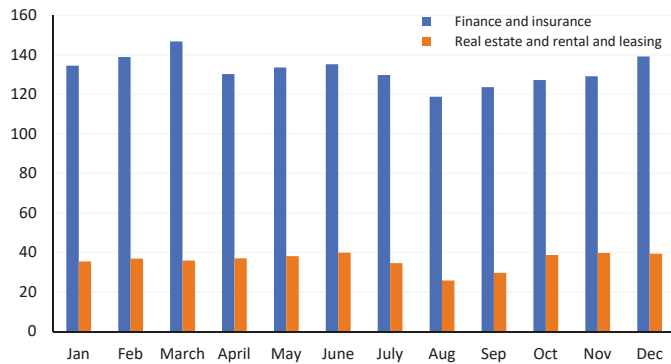
#### 4.3.2. Finance, Insurance, Real Estate, Rental and Leasing (FIRE)

The FIRE sector comprises entities engaged in financial transactions—those involving the creation, liquidation, or change in ownership of financial assets—or facilitating financial transactions.<sup>34</sup> Historically, it has been one of Ontario’s strongest sectors, accounting for two-thirds of its employees in the Toronto Economic Area (ER).<sup>35</sup> In 2020, it was the second-largest sector, accounting for 12% of all employment in Toronto (Table 3). This sector’s profits are closely correlated to interest rates, household and business credit use, return on investments and economic stability. The year 2020 started with an employee count of 169,095 and ended at 178,052, increasing by 2%, the highest gain reported compared to other sectors (Figure 23 and Table 2). The annual employment outpaced previous years, except for 2019, with both major subsectors—finance & insurance and real estate & leasing—showing strong reliance in the face of the COVID-19 lockdowns (Figure 24). Many factors contributed to stable employment in this sector. The banking system’s digitisation, the lack of equity stakes and lower claims in the insurance industry, and the continued sales growth in the detached housing market compensated for the sluggish numbers in the rentals and commercial real estate subsector. Approximately 25% of the finance and insurance workforce and 33% of the real estate subsectors could transfer to remote work due to the pandemic, one of the highest proportions among the sectors analysed (Figure A1, Appendix A).



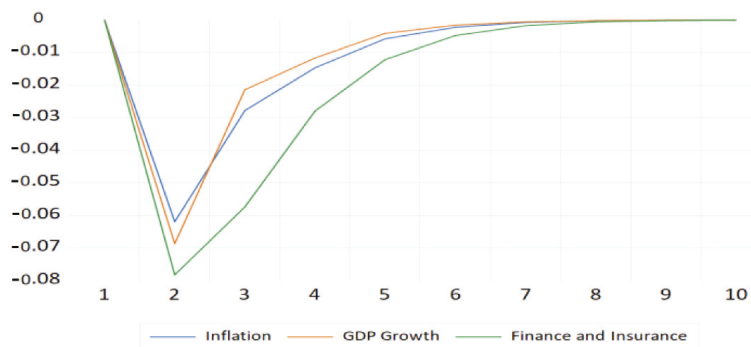
**Figure 23.** Employment in Finance, Insurance, Real Estate and Leasing sector. Despite a short-term drop in employment at the start of the pandemic in March, the levels recovered strongly, starting August. The y-axis of the figures represents the number of employees in 1000s. Source: Labour Force Survey, Statistics Canada.

In general, the insurance industry experienced little disruption during the pandemic. More than half of the industry was immune to declines in capital markets, as it held little or no equity in its portfolios, regardless of size (Grzadkowska 2020). The Office of the Superintendent of Financial Institutions (OSFI) also took measures to allow insurers to maintain work during the pandemic by postponing certain initiatives to allow insurers to focus on COVID-19.<sup>36</sup> Furthermore, a fall in the number of auto accidents during the lockdown led to fewer payouts by the auto insurance industry. As with the insurance industry, Toronto’s financial and banking industry was relatively unaffected due to support from the Bank of Canada and technological advancements in the banking system.<sup>37</sup> The digitisation of online banking and the increased use of direct deposits, e-transfers, and other app-based banking enabled many employees in the financial subsector to work from home and simplified banking for consumers stuck at home (Keefe and Monas 2020).



**Figure 24.** Employment in Finance, Insurance, Real Estate and Leasing sector—employment in key sub-sectors. The y-axis of the figures represents the number of employees in 1000s. Source: Labour Force Survey, Statistics Canada.

The real estate rental and leasing market experienced some fluctuations during the pandemic. The sales held steady during the pandemic but were not as strong as the Greater Toronto Area (GTA), which experienced a 24.3% increase from the previous year (Nanowski 2020). One residual effect of downtown residents’ moving to the suburbs was the decline in the condo market. In November 2020, condo market sales increased marginally by 0.8%, while prices dropped by 3%, compared to an increase of 13% in sales in other residential housing market segments (Zivitz 2020). As with the impact of increased suburban home sales on the condo market, an increase in available rental units was visible as renters took advantage of lower interest rates by moving to the suburbs (Macdonell 2020). The increase in available rental homes led to a dramatic drop in rental prices, with the price of a one-bedroom apartment in Toronto falling by 20.4% in 2020. The commercial real estate market did not fare well during the pandemic. With telecommuting and virtual work at an all-time high, there was an increase in Canada’s commercial vacancies of 10.8% in 2020 (Kerr 2020). The pandemic’s impulse response shows that the negative trend in response disappears in the seventh quarter (Figure 25 and Table A2, Appendix A).



**Figure 25.** Finance, Insurance, Real Estate and Leasing sector—IRF<sup>38</sup>. The figure depicts the impact of inflation, GDP growth for Ontario, and GDP in the FIRE sector, starting the first quarter of 2021. The negative effect on employment disappears in the seventh quarter with the convergence.

**5. Conclusions**

The results of this study show that COVID-19 has had an uneven impact on the various sectors of Toronto’s economy, with low-paying sectors suffering disproportionately,

leading to job losses. In particular, sectors such as accommodation & food services and manufacturing have suffered the most, with several others, such as retail, also facing a tremendous squeeze on revenues and viability. The results confirm similar findings in other countries such as Slovakia (Svabova et al. 2020), Portugal (Almeida and Santos 2020), Ireland (Byrne et al. 2020), the US (Bartik et al. 2020), UK (Harris et al. 2020) and Italy (Rapaccini et al. 2020).

While we limit our analysis to Toronto, we expect the impact to be similar in other areas of Canada, as evident by recent studies such as Roy et al. (2021), who analyse the effects of the pandemic on sectors such as Vancouver, another major city in Canada. The far-reaching impact of the pandemic means that targeted policy measures to help the ailing sectors are required. First, accommodation & food services and the manufacturing sector need assistance to deal with ongoing public health measures and a rapid increase in the use of technology at the expense of human labour. Second, adopting technology at the city level can increase the speed of new permit approval and recall of historical permit records to facilitate growth in the construction sector. Third, commercial tax breaks can address rising vacancies due to increased virtual work. Fourth, to attract residents back to the core, measures are needed to address the decline in commercial land usage, such as outdoor space development (parks and recreation). Fifth, repurposing commercial land to residential space, particularly affordable housing, can help increase housing affordability and reduce homelessness. Sixth, programmes for the most vulnerable segment of the population should focus on retraining to prepare for technology-oriented jobs in the future. Retraining and job readiness programmes can address the redundancy in organisations created by the increased use of technology. The impacts of the COVID-19 pandemic on Toronto will undoubtedly be widespread and unpredictable, but the focus remains on a strong recovery from the crisis despite this uncertainty. Navigating through the uncertainty of recovery can be positively supplemented by how the pandemic has forced changes in the various sectors of its economy. In guiding the city, policymakers need to understand these changes, trends, disruptions within sectors, and the effects on socio-economic groups.

**Author Contributions:** Conceptualization, V.S.; methodology, H.S. and V.S.; software, H.S.; validation, H.S.; formal analysis, V.S., H.S. and J.T.; investigation, V.S.; resources, V.S.; data curation, V.S. and H.S.; writing—original draft preparation, V.S.; writing—V.S., J.T., H.S. and review and editing, V.S. and J.T.; visualization, H.S.; supervision, V.S.; project administration, V.S.; funding acquisition, V.S. All authors have read and agreed to the published version of the manuscript.

**Funding:** This research was funded by MITACS and City of Toronto, grant number 1-51-47695. And The APC was funded by Ted Rogers School of Management, Ryerson University.

**Institutional Review Board Statement:** Not applicable.

**Informed Consent Statement:** Not applicable.

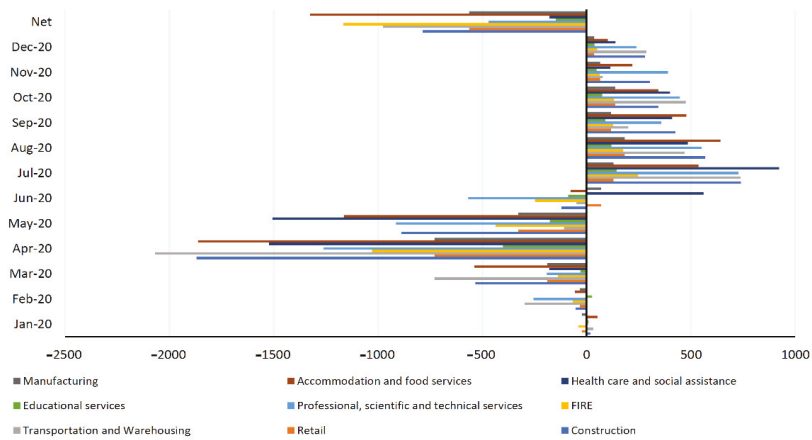
**Data Availability Statement:** Publicly available datasets were analyzed in this study. This data can be found here: <https://www150.statcan.gc.ca/n1/pub/11-625-x/11-625-x2010000-eng.htm> (accessed on 1 April 2021).

**Conflicts of Interest:** The authors declare no conflict of interest.

### Appendix A



**Figure A1.** Remote Work (Toronto). Source: Canadian Survey of Business Conditions, Statistics Canada.



**Figure A2.** Bankruptcy (opening–closing businesses). Notes: (1) Opening businesses transition from having no employees in the previous month to having at least one employee in the current month. These instances occur when a new small firm begins, when a large firm opens a new establishment or when a seasonal firm reopens. (2) Closing businesses are those that transition from having at least one employee in the previous month to having no employees in the current month. These instances occur when a small firm goes out of business, when a large firm closes an establishment temporarily or permanently, and when a seasonal firm ceases business activity for the year. (3) Net: refers to the aggregate number for the year. Source: Longitudinal Employment Analysis Program, Statistics Canada.

Table A1. Closing businesses as a % of active business.

	January-2020	February-2020	March-2020	April-2020	May-2020	June-2020	July-2020	August-2020	September-2020	October-2020	November-2020	December-2020	Avg. 2019	Avg. 2020
Construction	5%	5%	8%	18%	13%	9%	4%	4%	4%	5%	5%	5%	5%	7%
Manufacturing	3%	3%	4%	12%	8%	5%	4%	2%	2%	2%	3%	3%	3%	4%
Retail	4%	3%	6%	22%	15%	10%	3%	3%	3%	3%	4%	4%	4%	7%
Transportation & warehousing	8%	8%	11%	24%	10%	10%	7%	7%	7%	7%	7%	7%	8%	9%
Finance and insurance and management of companies and enterprises	5%	5%	5%	11%	7%	6%	5%	5%	5%	5%	5%	5%	5%	6%
Real estate and rental and leasing	5%	5%	6%	14%	11%	10%	4%	5%	5%	6%	6%	6%	5%	7%
Professional, scientific and technical services	6%	6%	6%	11%	9%	8%	5%	5%	5%	5%	5%	6%	6%	7%
Educational services	4%	3%	5%	25%	15%	11%	4%	3%	3%	3%	3%	4%	5%	7%
Health care and social assistance	3%	3%	4%	13%	14%	7%	3%	2%	2%	3%	3%	3%	3%	5%
Accommodation & food services	3%	4%	9%	27%	22%	13%	5%	2%	3%	3%	4%	5%	4%	8%

Notes: (1) The data is for Toronto. (2) Active businesses are those businesses that reported having one or more employees in a given month. Closing businesses are those that transition from having at least one employee in the previous month to having no employees in the current month. These instances occur when a small firm goes out of business, when a large firm closes an establishment temporarily or permanently, and when a seasonal firm ceases business activity for the year. Source: Longitudinal Employment Analysis Program, Statistics Canada.

Table A2. Impulse Response to COVID-19.

Period	Accommodation & Food Services	Manufacturing	Retail Trade	Transportation & Warehousing	Educational Services	Construction	FIRE	Professional Scientific & Technical
1	0	0	0	0	0	0	0	0
2	-0.212	-0.1068	-0.0808	-0.0792	-0.0148	0.2006	-0.0782	-0.1062
3	-0.0439	-0.0689	0.0124	0.0863	-0.0419	-0.3233	-0.0574	-0.1303
4	0.1257	-0.0554	-0.1407	0.1026	-0.0022	-0.0718	-0.028	-0.0748
5	0.0937	-0.0413	-0.1163	0.0205	0.1889	0.1625	-0.0122	-0.0327
6	-0.1261	-0.0312	-0.0532	-0.0285	-0.1248	-0.5813	-0.0048	-0.0072
7	-0.2412	-0.0235	-0.0456	-0.0199	-0.0178	0.357	-0.0018	0.0029
8	-0.1028	-0.0178	-0.0188	0.0025	0.0789	-0.1734	-0.0006	0.0047
9	0.1039	-0.0134	-0.0149	0.0089	-0.0678	-0.334	-0.0002	0.0034
10	0.1133	-0.0101	-0.0174	0.0029	0.0161	0.5125	-0.0001	0.0017

Note: The response refers to the impact on employment due to the COVID-19 shock starting in the first quarter of 2021. The periods refer to the quarters.

## Notes

- 1 Source: <https://www.forbes.com/sites/bernardmarr/2018/09/02/what-is-industry-4-0-heres-a-super-easy-explanation-for-anyone/?sh=5b5d8a599788> (accessed on 15 September 2021).
- 2 Source: <https://www.weforum.org/agenda/2021/11/how-tech-4-0-helped-companies-survive-covid-19/> (accessed on 11 December 2021).
- 3 The forecast from the VAR model for each sector starts from the fourth quarter of 2020 and lasts for 10 periods. The use of 10 period allows us to measure a reasonable future response to the shock. It should be noted that the use of such time horizon corresponds to standard practice in the literature, for example, see Darolles and Gourieroux (2015); Oscar Jordà (2005) and Koop et al. (1996).
- 4 We chose optimal lag of 1 according to AIC and SC information criteria for Accommodation & food services, Manufacturing, Retail trade, Transportation & warehousing, Educational services, Professional scientific & technical, and Finance, insurance, real estate and leasing sectors. For the Construction sector, the optimal lag is 2.
- 5 The same VAR model was estimated for each sector to obtain the Impulse Response Functions (IRFs).
- 6 We use monthly data from 2017 to 2020.
- 7 A cutoff criterion of 5% of total employment is used to identify the top sectors.
- 8 Source: <https://www23.statcan.gc.ca/imdb/p3VD.pl?Function=getVD&TVD=118464&CVD=118465&CPV=72&CST=01012012&CLV=1&MLV=5> (accessed on 15 March 2021).
- 9 Source: [https://www.jobbank.gc.ca/content\\_pieces-eng.do?cid=12204](https://www.jobbank.gc.ca/content_pieces-eng.do?cid=12204) (accessed on 15 March 2021).
- 10 Ibid.
- 11 The responses of unemployment to Cholesky One S.D (d. f. adjusted) Innovations  $\pm 2$  S. E.
- 12 Source: <https://www23.statcan.gc.ca/imdb/p3VD.pl?Function=getVD&TVD=118464&CVD=118465&CPV=31-33&CST=01012012&CLV=1&MLV=5> (accessed on 15 March 2021).
- 13 Source: <https://www150.statcan.gc.ca/n1/daily-quotidien/200715/dq200715a-eng.htm> (accessed on 17 March 2021).
- 14 The responses of unemployment to Cholesky One S.D (d. f. adjusted) Innovations  $\pm 2$  S. E.
- 15 Source: <https://www23.statcan.gc.ca/imdb/p3VD.pl?Function=getVD&TVD=118464&CVD=118465&CPV=44-45&CST=01012012&CLV=1&MLV=5> (accessed on 15 March 2021).
- 16 Retail e-commerce sales in Canada increased from 2.9 billion in July 2020 to 4.3 billion in November 2020. Source: <https://www150.statcan.gc.ca/t1/tbl1/en/tv.action?pid=2010007201> (accessed on 15 March 2021).
- 17 Source: <https://www150.statcan.gc.ca/t1/tbl1/en/tv.action?pid=2010007401> (accessed on 17 March 2021).
- 18 The responses of unemployment to Cholesky One S.D (d. f. adjusted) Innovations  $\pm 2$  S. E.
- 19 Source: <https://www23.statcan.gc.ca/imdb/pD.pl?Function=getVD&TVD=118464&CVD=118465&CPV=48-49&CST=01012012&CLV=1&MLV=5> (accessed on 15 March 2021).
- 20 Source: [https://www.jobbank.gc.ca/content\\_pieces-eng.do?cid=14662](https://www.jobbank.gc.ca/content_pieces-eng.do?cid=14662) (accessed on 15 March 2021).
- 21 Source: <https://www.cbc.ca/radio/asithappens/as-it-happens-Tuesday-edition-1.5851623/ontario-lockdown-doesn-t-do-a-nything-to-help-warehouse-workers-says-advocate-1.5852114> (accessed on 15 March 2021).
- 22 Source: <http://www.ttc.ca/Coupler/Editorial/Notices/index.jsp> (accessed on 20 March 2021).
- 23 Source: <https://travel.gc.ca/travel-covid/travel-restrictions/border> (accessed on 20 March 2021).
- 24 The responses of unemployment to Cholesky One S.D (d. f. adjusted) Innovations  $\pm 2$  S. E.
- 25 Source: <https://www23.statcan.gc.ca/imdb/p3VD.pl?Function=getVD&TVD=118464&CVD=118465&CPV=62&CST=01012012&CLV=1&MLV=5> (accessed on 15 March 2021).
- 26 Source: <https://www23.statcan.gc.ca/imdb/p3VD.pl?Function=getVD&TVD=118464&CVD=118465&CPV=61&CST=01012012&CLV=1&MLV=5> (accessed on 15 March 2021).
- 27 Source: [https://www.jobbank.gc.ca/content\\_pieces-eng.do?cid=15197](https://www.jobbank.gc.ca/content_pieces-eng.do?cid=15197) (accessed on 15 March 2021).
- 28 Source: <https://www150.statcan.gc.ca/n1/daily-quotidien/201009/dq201009a-eng.htm> (accessed on 17 March 2021).
- 29 The responses of unemployment to Cholesky One S.D (d. f. adjusted) Innovations  $\pm 2$  S. E.
- 30 Source: <https://www23.statcan.gc.ca/imdb/pD.pl?Function=getVD&TVD=118464&CVD=118465&CPV=23&CST=01012012&CLV=1&MLV=5> (accessed on 15 March 2021).
- 31 The responses of unemployment to Cholesky One S.D (d. f. adjusted) Innovations  $\pm 2$  S. E.
- 32 Source: <https://www23.statcan.gc.ca/imdb/p3VD.pl?Function=getVD&TVD=118464&CVD=118465&CPV=54&CST=01012012&CLV=1&MLV=5> (accessed on 15 March 2021).
- 33 The responses of unemployment to Cholesky One S.D (d. f. adjusted) Innovations  $\pm 2$  S. E.
- 34 Source: <https://www23.statcan.gc.ca/imdb/p3VD.pl?Function=getVD&TVD=118464&CVD=118465&CPV=52&CST=01012012&CLV=1&MLV=5> (accessed on 15 March 2021).

- 35 Source: [https://www.jobbank.gc.ca/content\\_pieces-eng.do?cid=14525](https://www.jobbank.gc.ca/content_pieces-eng.do?cid=14525) (accessed on 15 March 2021).
- 36 Source: <https://www.osfi-bsif.gc.ca/Eng/Pages/COVID-19.aspx> (accessed on 19 March 2021).
- 37 Source: <https://www.bankofcanada.ca/2020/05/financial-system-review-2020/> (accessed on 17 March 2021).
- 38 The responses of unemployment to Cholesky One S.D (d. f. adjusted) Innovations  $\pm 2$  S. E.

## References

- Adams-Prassl, Abi, Teodora Boneva, Marta Golin, and Christopher Rauh. 2020. *Work That Can Be Done from Home: Evidence on Variation within and across Occupations and Industries*. Discussion Paper Series. Bonn: IZA Institute of Labor Economics.
- Almeida, Fernando, and José Duarte Santos. 2020. The effects of COVID-19 on job security and unemployment in Portugal. *International Journal of Sociology and Social Policy* 40: 995–1003. [CrossRef]
- Andersen, Asger Lau, Emil Toft Hansen, Niels Johannesen, and Adam Sheridan. 2020. *Consumer Responses to the COVID-19 Crisis: Evidence from Bank Account Transaction Data*. CEBI Working Paper, No. 18/20. Copenhagen: Center for Economic Behaviour and Inequality, University of Copenhagen. [CrossRef]
- Barrero, Jose Maria, Nicholas Bloom, and Steven J. Davis. 2020. *COVID-19 Is Also a Reallocation Shock*. NBER Working Paper Series, 27137. Cambridge: National Bureau of Economic Research.
- Bartik, Alexander W., Marianne Bertrand, Feng Lin, Jesse Rothstein, and Matt Unrath. 2020. *Measuring the Labor Market at the Onset of the COVID-19 Crisis*. NBER Working Paper, w27613. Cambridge: National Bureau of Economic Research.
- Béland, Louis-Philippe, Abel Brodeur, and Taylor Wright. 2020. *The Short-Term Economic Consequences of Covid-19: Exposure to Disease, Remote Work and Government Response*. Discussion Paper Series, 13197. Bonn: IZA Institute of Labour Economics.
- Blundell, Richard, Monica Costa Dias, Robert Joyce, and Xiaowei Xu. 2020. COVID-19 and Inequalities. *Fiscal Studies* 41: 291–319. [CrossRef] [PubMed]
- Byrne, Stephen, Dermot Coates, Enda Keenan, and Tara McIndoe-Calder. 2020. The initial labour market impact of COVID-19. *Central Bank Economic Letter* 4: 25.
- Ceylan, Rahmiye Figen, Burhan Ozkan, and Esra Mulazimogullari. 2020. Historical evidence for economic effects of COVID-19. *The European Journal of Health Economics* 21: 817–23. [CrossRef]
- Churchill, Brendan. 2021. COVID-19 and the immediate impact on young people and employment in Australia: A gendered analysis. *Gender, Work & Organisation* 28: 783–94.
- Darolles, Serge, and Christian Gourieroux. 2015. *Contagion Phenomena with Applications in Finance*. Amsterdam: Elsevier.
- Deng, Zechuan, René Morissette, and Derek Messacar. 2020. Running the Economy Remotely: Potential for Working from Home during and after COVID-19. In *Statcan COVID-19: Data to Insights for a Better Canada*. Ottawa: Statistics Canada.
- Goddard, Ellen. 2020. The impact of COVID-19 on food retail and food service in Canada: Preliminary assessment. *Canadian Journal of Agricultural Economics/Revue Canadienne D'agroeconomie* 68: 157–61. [CrossRef]
- Goolsbee, Austan, and Chad Syverson. 2020. *Fear, Lockdown, and Diversion: Comparing Drivers of Pandemic Economic Decline 2020*. NBER Working Paper, 27432. Cambridge: National Bureau of Economic Research. [CrossRef]
- Gormsen, Niels Joachim, and Ralph S. J. Koijen. 2020. Coronavirus: Impact on stock prices and growth expectations. *The Review of Asset Pricing Studies* 10: 574–97. [CrossRef]
- Grzadzowska, Alicja. 2020. Short and Long-Term Impacts of the Coronavirus on Canadian Insurers. Insurance Business Canada. Available online: <https://www.insurancebusinessmag.com/ca/news/breaking-news/short-and-longterm-impacts-of-the-coronavirus-on-canadian-insurers-225115.aspx> (accessed on 18 March 2021).
- Gupta, Sumedha, Laura Montenegro, Thuy Dieu Nguyen, Felipe Lozano-Rojas, Ian M. Schmutte, Kosali Ilayperuma Simon, Bruce A. Weinberg, and Coady Wing. 2020. *Effects of Social Distancing Policy on Labor Market Outcomes*. NBER Working Paper, 27280. Cambridge: National Bureau of Economic Research.
- Habib, Khandker Nurul, Jason Hawkins, Saeed Shakib, Patrick Loa, Sk Mashrur, Alireza Dianat, Kaili Wang, Sanjana Hossain, and Yicong Liu. 2021. Assessing the impacts of COVID-19 on urban passenger travel demand in the Greater Toronto Area: Description of a multi-pronged and multi-staged study with initial results. *Transportation Letters* 13: 353–66. [CrossRef]
- Harris, Jack L., Peter Sunley, Emil Evenhuis, Ron Martin, Andy Pike, and Richard Harris. 2020. The Covid-19 crisis and manufacturing: How should national and local industrial strategies respond? *Local Economy* 35: 403–15. [CrossRef]
- Ingravallo, Francesca. 2020. Death in the era of the COVID-19 pandemic. *The Lancet Public Health* 5: e258. [CrossRef]
- Jordà, Òscar. 2005. Estimation and inference of impulse responses by local projections. *The American Economic Review* 95: 161–82. [CrossRef]
- Keefe, Blair W., and Eli Monas. 2020. Canada's Financial Sector: An Industry in Transformation. *Torlys Quarterly: The Race to Transform: Canada's Financial Services*. Available online: <https://www.torlys.com/insights/publications/2020/10/canadas-financial-sector-an-industry-in-transformation> (accessed on 15 July 2021).
- Kerr, Kathy. 2020. Commercial Real Estate: Trends to Watch in 2021. *The Globe and Mail*. December 1. Available online: <https://www.theglobeandmail.com/featured-reports/article-commercial-real-estate-trends-to-watch-in-2021/> (accessed on 15 June 2021).
- Koop, Gary, M. Hashem Pesaran, and Simon M. Potter. 1996. Impulse response analysis in nonlinear multivariate models. *Journal of Econometrics* 74: 119–47. [CrossRef]



- Lemieux, Thomas, Kevin Milligan, Tammy Schirle, and Mikal Skuterud. 2020. Initial impacts of the COVID-19 pandemic on the Canadian labour market. *Canadian Public Policy* 46: S55–S65. [CrossRef]
- Lichtenthaler, Philipp, and Andrea Fischbach. 2019. A meta-analysis on promotion-and prevention-focused job crafting. *European Journal of Work and Organizational Psychology* 28: 30–50. [CrossRef]
- Lundy, Matt. 2021. A Devastatingly Poor Year: Why the Outlook for Business Travel Remains Bleak. *The Globe and Mail*. Available online: <https://www.theglobeandmail.com/business/article-will-corporate-travel-rebound-in-2021-dont-count-on-it/> (accessed on 18 March 2021).
- Macdonell, Beth. 2020. Once in a Lifetime Rental Market Price Drop Leads to Crazy Incentives. *CTV News*. October 24. Available online: <https://toronto.ctvnews.ca/once-in-a-lifetime-rental-market-price-drop-leads-to-crazy-incentives-1.5159306> (accessed on 15 March 2021).
- Milani, Fabio. 2021. COVID-19 outbreak, social response, and early economic effects: A global VAR analysis of cross-country interdependencies. *Journal of Population Economics* 34: 223–52. [CrossRef]
- Nanowski, Natalie. 2020. A Year in Real Estate Review: Toronto's Biggest Trends of 2020. *CBC News*. December 20. Available online: <https://www.cbc.ca/news/canada/toronto/toronto-realestate-ontario-homes-condo-pandemic-1.5847995> (accessed on 15 March 2021).
- Ozili, Peterson K., and Thankom Arun. 2020. Spillover of COVID-19: Impact on the Global Economy. Available online: [https://papers.ssrn.com/sol3/papers.cfm?abstract\\_id=3562570](https://papers.ssrn.com/sol3/papers.cfm?abstract_id=3562570) (accessed on 10 June 2021).
- Rapaccini, Mario, Nicola Saccani, Christian Kowalkowski, Marco Paiola, and Federico Adrodegari. 2020. Navigating disruptive crises through service-led growth: The impact of COVID-19 on Italian manufacturing firms. *Industrial Marketing Management* 88: 225–37. [CrossRef]
- Rojas, Felipe Lozano, Xuan Jiang, Laura Montenovio, Kosali I. Simon, Bruce A. Weinberg, and Coady Wing. 2020. *Is the Cure Worse than the Problem Itself? Immediate Labor Market Effects of COVID-19 Case Rates and School Closures in the U.S.*. NBER Working Paper, 27127. Cambridge: National Bureau of Economic Research. [CrossRef]
- Roy, Hiran, Vikas Gupta, Anisur R. Faroque, and Alpa Patel. 2021. The impact of COVID-19 on the foodservice industry in Vancouver, British Columbia, Canada. *Anatolia* 32: 157–60. [CrossRef]
- Rymarczyk, Jan. 2020. Technologies, opportunities and challenges of the industrial revolution 4.0: Theoretical considerations. *Entrepreneurial Business and Economics Review* 8: 185–98. [CrossRef]
- Shestakofsky, Benjamin. 2017. Working algorithms: Software automation and the future of work. *Work and Occupations* 44: 376–423. [CrossRef]
- Svabova, Lucia, and Barbora Gabrikova. 2021. The rise in youth employment? Impact evaluation of COVID-19 consequences. *Journal of Eastern European and Central Asian Research* 8: 511–26. [CrossRef]
- Svabova, Lucia, and Katarína Kramarova. 2021. An analysis of participation factors and effects of the active labour market measure Graduate practice in Slovakia—Counterfactual approach. *Evaluation and Program Planning* 86: 101917. [CrossRef] [PubMed]
- Svabova, Lucia, Zdenko Metzker, and Tomasz Pisula. 2020. Development of unemployment in Slovakia in the context of the COVID-19 pandemic. *Ekonomicko-Manazerske Spektrum* 14: 114–23. [CrossRef]
- Tal, Benjamin. 2021. Canadian labour market dichotomy—Deeper than perceived. In *Focus*. Toronto: CIBC Economics. Available online: [https://economics.cibccm.com/economicsweb/cds?ID=12030&TYPE=EC\\_PDF](https://economics.cibccm.com/economicsweb/cds?ID=12030&TYPE=EC_PDF) (accessed on 24 January 2022).
- UN. 2020. The Impact of COVID-19 on Women. Policy Brief. Available online: <https://www.unwomen.org/-/media/headquarters/attachments/sections/library/publications/2020/policy-brief-the-impact-of-covid-19-on-women-en.pdf?la=en&vs=1406> (accessed on 10 June 2021).
- Yasenov, Vasil. 2020. *Who Can Work from Home?* Discussion Paper Series, 13197. Bonn: IZA Institute of Labour Economics.
- Zivitz, Noah. 2020. *Toronto Home Prices Fall from Record as Condo Market Goes Cold*. Toronto: BNN Bloomberg. Available online: <https://www.bnnbloomberg.ca/toronto-home-prices-fall-from-record-high-as-condo-market-goes-cold-1.1530951> (accessed on 24 January 2022).

Article

# Stock Price Forecasting for Jordan Insurance Companies Amid the COVID-19 Pandemic Utilizing Off-the-Shelf Technical Analysis Methods

Ghada A. Altarawneh <sup>1</sup>, Ahmad B. Hassanat <sup>2,\*</sup>, Ahmad S. Tarawneh <sup>3</sup>, Ahmad Abadleh <sup>2</sup>, Malek Alrashidi <sup>4</sup> and Mansoor Alghamdi <sup>4</sup>

<sup>1</sup> Accounting Department, Mutah University, Mutah 6171, Jordan; Ghadaa@Mutah.edu.jo

<sup>2</sup> Faculty of Information Technology, Mutah University, Mutah 6171, Jordan; abadleh@gmail.com

<sup>3</sup> Faculty of Informatics, ELTE University, 1117 Budapest, Hungary; Ahmadrtr@caesar.elte.hu

<sup>4</sup> Computer Science Department, Community College, University of Tabuk, Tabuk 71491, Saudi Arabia; Mqalrashidi@ut.edu.sa (M.A.); malghamdi@ut.edu.sa (M.A.)

\* Correspondence: ahmad.Hassanat@gmail.com

**Abstract:** One of the most difficult problems analysts and decision-makers may face is how to improve the forecasting and predicting of financial time series. However, several efforts were made to develop more accurate and reliable forecasting methods. The main purpose of this study is to use technical analysis methods to forecast Jordanian insurance companies and accordingly examine their performance during the COVID-19 pandemic. Several experiments were conducted on the daily stock prices of ten insurance companies, collected by the Amman Stock Exchange, to evaluate the selected technical analysis methods. The experimental results show that the non-parametric Exponential Decay Weighted Average (EDWA) has higher forecasting capabilities than some of the more popular forecasting strategies, such as Simple Moving Average, Weighted Moving Average, and Exponential Smoothing. As a result, we show that using EDWA to forecast the share price of insurance companies in Jordan is good practice. From a technical analysis perspective, our research also shows that the pandemic had different effects on different Jordanian insurance companies.

**Keywords:** financial time series forecasting; stock markets; forecasting methods; technical analysis

**Citation:** Altarawneh, Ghada A., Ahmad B. Hassanat, Ahmad S. Tarawneh, Ahmad Abadleh, Malek Alrashidi, and Mansoor Alghamdi. 2022. Stock Price Forecasting for Jordan Insurance Companies Amid the COVID-19 Pandemic Utilizing Off-the-Shelf Technical Analysis Methods. *Economics* 10: 43. <https://doi.org/10.3390/economics10020043>

Academic Editor: Ștefan Cristian Gherghina

Received: 30 December 2021

Accepted: 26 January 2022

Published: 7 February 2022

**Publisher's Note:** MDPI stays neutral with regard to jurisdictional claims in published maps and institutional affiliations.



**Copyright:** © 2022 by the authors. Licensee MDPI, Basel, Switzerland. This article is an open access article distributed under the terms and conditions of the Creative Commons Attribution (CC BY) license (<https://creativecommons.org/licenses/by/4.0/>).

## 1. Introduction

According to the Amman Stock Exchange (ASE), Jordan now has 20 insurance businesses listed, as well as several companies that have been liquidated owing to financial problems. This is a huge number for a small country such as Jordan, whose insurance market is relatively small compared to many of its regional peers, contributing to around 3% of the MENA region's gross written premiums. In particular, this is seen when compared to a much larger country such as Egypt, which only has 32 insurance companies, some of which are among the region's oldest (Oxford Business Group 2017). Only the Arab Orient Insurance Company (with a 16.5% share of gross premiums), Jordan Insurance (10.14%), and Middle East Insurance (7.35%) exceeded the 5% market share threshold in the first half of 2013, according to data from the Jordan Insurance Federation (JOIF), along with First Insurance claiming a share of 4.9% of the Jordanian market (Oxford Business Group 2017).

Despite the potential need for consolidation, the business has been devoid of mergers and acquisitions for more than two decades. Because the majority of the market is concentrated on third-party vehicle insurance, whose premiums are set by the government, merging two motor-focused companies to form a larger one makes no sense.

Furthermore, some companies have lacked the solvency margin since 2015, and they have neither been warned nor taken legal action to rectify the situation. Another big issue arises in the vehicle insurance market by bypassing or evading the concept of compulsory

insurance; the victim is the citizen, who falls into the trap of some insurance brokers, while the reputation of the sector suffers as a result. Furthermore, the increase in the market share of some compulsory insurance companies in violation or circumvention of the instructions represents an increase in the number of insured citizens who will become potential victims of these companies' inability to fulfill their obligations to them, even if they have a solvency margin equal to or exceeding the minimum. It generates enough profit from its operations to offset losses resulting from compulsory insurance.

The challenge for insurers stems from the regulatory requirement that, in order to sell comprehensive coverage, companies must also provide third-party liability (TPL) coverage at a government-determined rate. TPL premiums are now low, according to the industry, and many insurers accept losses on this line of business, which they try to offset with more profitable comprehensive offers. As a result, technical outcomes are under pressure, which will persist if the industry faces structural challenges (Oxford Business Group 2020).

These challenges, among other things, resulted in financial losses and caused some insurance companies to be hesitant to pay claims, as well as harming the industry's reputation. After the COVID-19 pandemic in early 2020, the financial status of this industry will deteriorate much further. We will use technical analysis tools to forecast the share price of a randomly selected Jordan insurance company in order to shed light on their performance and determine which technical analysis tool is the best suited for forecasting.

Due to the instable and complex nature of such markets, data amount, high degree of ambiguity, noise, and the fact that they are always affected by numerous factors, forecasting the stock market and other traded financial instruments has always been a challenging task (Khan 2014; Agrawal et al. 2013; Ghatasheh et al. 2020). Stock market forecasting refers to the actions made to provide interested parties, such as investors and customers, with a predictable picture of the future direction and variation of the object price. Investors could make successful decisions or prevent losses if they could accurately forecast future stock prices (Singh et al. 2019, 2021; Sunny et al. 2020; Lin et al. 2020; Shynkevich et al. 2017; Mehta et al. 2021; Zhuo et al. 2021).

We argue that the choice of a technical analysis tool is governed by the ambiguity and subjectivity that surrounds determining the optimal time range for a predictor to consider when making a valid estimate. This is because there is no optimal time range and no consensus among analysts on what number of days, months, or years from a time series the forecaster should choose in order to make an acceptable and accurate forecasting. Choosing different periods may have an impact on the accuracy of forecasting and result in various outcomes. For example, we choose different periods of data for both well-known simple moving average (SMA), and weighted moving average (WMA) to forecast the price share of one of the insurance companies, namely Middle East Insurance. We evaluate the forecasting outcome using different error measures such as mean absolute error (MAE), mean percentage error (MPE), mean square error (MSE), tracking signal (TS), and mean absolute percent error (MAPE). Table 1 shows these pilot results.

As can be seen in Table 1, which shows that depending on the time range used (5, 10, 15 and 20 days), SMA and WMA showed different results. As a result, this could lead to incorrect stock price forecasts and thus poor investment decisions. For example, the errors in the results are higher when using 20 days than when using a period of 10 days. Accordingly, the significance of the time frame chosen, which is heavily dependent on personal experience, determines the stock's price prediction and accuracy. On the contrary, our EDWA will consider all available data points in a time series dataset.

As can be seen in Table 1, which shows that depending on the time range used (5, 10, 15, and 20 days), SMA and WMA showed different results. As a result, this could lead to incorrect stock price forecasts and thus poor investment decisions. For example, the errors in the results are higher when using 20 days than when using a period of 10 days. Accordingly, the significance of the time frame chosen, which is heavily dependent on personal experience, determines the stock's price prediction and accuracy. On the contrary, our EDWA will consider all available data points in a time series dataset.

**Table 1.** The performance of SMA and WMA using the daily closing prices of Middle East Insurance inc. in 2020. Data obtained from Amman stock exchange ([https://www.ase.com.jo/en/company\\_historical/MEIN](https://www.ase.com.jo/en/company_historical/MEIN), accessed on 1 November 2021). STD: standard deviation.

Method	Period (Days)	MAE	MAPE	MPE	MSE	TS
SMA	5	0.0463	0.0361	0.0068	0.0040	0.1509
	10	0.0498	0.0389	0.0105	0.0048	0.2234
	15	0.0476	0.0373	0.0124	0.0041	0.2895
	20	0.0480	0.0378	0.0147	0.0042	0.3471
	STD	0.0015	0.0012	0.0033	0.0003	0.0846
WMA	5	0.1078	0.0805	−0.0469	0.0988	−0.6131
	10	0.2188	0.1653	−0.1325	0.2450	−0.8179
	15	0.3284	0.2492	−0.2172	0.3899	−0.8830
	20	0.4395	0.3317	−0.2995	0.5437	−0.9124
	STD	0.1426	0.1082	0.1088	0.1911	0.1349

To avoid the time parameter, we contemplate our earlier nonparametric forecasting method (Altarawneh 2019; Hassanat et al. 2021), known as the Exponential Decay Weighted Average (EDWA), comparing it with other technical analysis tools, to predict the share price of Jordanian insurance companies, especially during the COVID-19 period, and see which is a viable tool for forecasting stock prices.

Basically, WMA and exponential smoothing approaches (ES) are both used to create the EDWA forecasting method. This method considers the entire time series as we argue that a technical analysis method that takes into account all data, not just some historical data points, is beneficial for forecasting in general, and for forecasting stock price of Jordanian insurance companies in particular, as these companies' challenges and problems have persisted for a long time.

Since the most recent share price is more relevant and important than previous prices, EDWA also weights it more heavily. However, this allows other factors to affect stock prices as we dig deeper into a time series. Therefore, we weight the current prices higher, which are influenced by current factors, such as the COVID-19 pandemic, while also giving lower weights to the older prices, which are influenced by older factors that are still influencing the stock price. It is worth noting that the literature confirms that no single method or model can 100% accurately assess and anticipate complex data patterns; in addition, a wide variety of economic and non-economic factors also influence stock markets (Agrawal et al. 2013; Santos 2011; Fikru 2019).

## 2. Related Literature

The random walk theory (Fama et al. 1969; Fama 1995), and the Efficient Market Hypothesis (Fama 1965) were used as primary models on which a variety of stock market prediction methodologies were built. On the other hand, investigations based on these models revealed that the price of a stock cannot be accurately forecast. Although the financial market is difficult, chaotic, unstable, nonlinear, and dynamic in nature, it can be anticipated with an accuracy of more than 50%, according to some empirical studies (Malkiel 2003; Prechter and Parker 2007; Bollen et al. 2011), and it does not follow the random walk model (Lo and MacKinlay 1988).

To forecast the stock's trend, a plethora of methodologies have been employed in the literature. Technical analysis, Fundamental analysis, and Machine learning methods are the three primary themes of prediction methodologies used.

Technical analysis is an approach employed to forecast the direction and movement of future stocks price and other traded securities, using solely the company's historical stock prices and trading volumes. In technical analysis, we look at the price data patterns that demonstrate continuations or setbacks in a stock market trend. Technical analysis encompasses numerous techniques, such as the simple moving average (SMA), exponential smoothing (ES), weighted moving average (WMA), Candlestick Agent, and others. In the

financial field, most of the traditional techniques of stock price prediction use statistical methods, which were generated from historical data.

The approach of technical analysis is used extensively for predicting future stock prices based purely on the company's previous trading volumes and stock prices (Turner 2007; Chourmouziadis and Chatzoglou 2016). In technical analysis, we look at price data patterns to see if the stock market trend is continuing or reversing. SMA, ES, WMA, Candlestick Agent, and other approaches are all used in technical analysis. Most classic stock price prediction strategies in the financial world rely on statistical methodologies derived from past data (Park and Irwin 2007; Edwards et al. 2012; Nti et al. 2020).

The fundamental analysis approach, on the other hand, evaluates the company's intrinsic values based on an examination of its financial statements and economic indicators in order to forecast future stock prices, examples of such approach include (Chen and Chen 2013; Drakopoulou 2016; Chen et al. 2017; Abarbanell and Bushee 1997; Muhammad 2018).

Artificial neural networks and Genetic Algorithms among others are examples of tools and methodologies used in artificial intelligence research field to anticipate stock market movements. Many studies have looked into the benefits of using such approaches including and are not limited to (Nevasalmi 2020; Patel et al. 2015; Khan et al. 2020; Nabipour et al. 2020; Zhong and Enke 2019; Singh 2018; Chowdhury et al. 2020; Valencia et al. 2019). In addition to a slew of other studies attempting to build and discover new machine learning approaches, including (Qiu and Yu 2016; Narloch et al. 2019; Khashei and Hajirahimi 2018; Samer et al. 2018; Abadleh et al. 2021; Chi 2018). Artificial intelligence and Machine learning in particular are not just for prediction and forecasting; they are also employed in a variety of other areas such as Natural Language Processing (Alghamdi and Teahan 2017; Hassanat and Altarawneh 2014; Hassanat and Jassim 2010; Al-Shamaileh et al. 2019; Hassanat et al. 2015b, 2015c; Tarawneh et al. 2020a; Hassanat and Tarawneh 2016), Software engineering (Salman et al. 2018; Eyal Salman 2017; Eyal Salman et al. 2015), Internet of things (Mnasri et al. 2014, 2015, 2017a, 2017b, 2018a, 2018b, 2019, 2020; Abdallah et al. 2020a, 2020b; Tlili et al. 2021), Computer vision (AlTarawneh et al. 2017; Alqatawneh et al. 2019; Tarawneh et al. 2018, 2019a, 2019b, 2020b; Al-Btoush et al. 2019; Hassanat et al. 2015a, 2017a, 2017b, 2018a; Hassanat and Tarawneh 2016; Hassanat 2018e), Game theory (De Voogt et al. 2017; Hassanat et al. 2018b), Big data classification (Hassanat 2018a, 2018b, 2018c, 2018d, 2018e), Security Network and Anomaly Detection (Al-kasassbeh and Khairallah 2019; Al-Naymat et al. 2018; Zuraïq and Alkasassbeh 2019; Almseidin et al. 2019a, 2019b, 2019c; Abuzuraïq et al. 2020; Al-Kasassbeh et al. 2019; Almseidin et al. 2019c; Alothman et al. 2020; Rawashdeh et al. 2018; Alkasassbeh 2018; Hassanat et al. 2022). Security is a field that can benefit from machine learning techniques. Using a biometric key derived from machine learning models, it is possible to maintain a communication link between senders and receivers (Hamadaqa et al. 2019; Mulhem et al. 2019; Mars et al. 2019). Moreover, the use of machine learning can be applied to indoor localization and distance estimation (Alabadleh et al. 2018; Aljaafreh et al. 2017; Abadleh et al. 2016, 2017).

Forecasting practitioners, on the other hand, demonstrate the utility and application of technical analysis. This is particularly evident on financial websites and in newspapers that process financial and statistical data using technical analysis. Furthermore, in recent years, study on the profitability of technical analysis has expanded. For example, (Park and Irwin 2007) reviewed studies that investigated the potential profits provided by technical analysis. They discovered that technical analysis consistently generates profit in a variety of markets, including the stock and foreign currency markets.

According to (Mitra 2011), most technical trading techniques may reasonably capture the direction of market moves and provide considerable positive returns in both long and short positions. In another interesting study (Vasiliou et al. 2006), the Athens Stock Exchange was used to see how well simple technical analysis can forecast stock price fluctuations. This study looked into these consequences for the Athens market's most important index, the Athens General Index. Standard tests and bootstrap are among the

approaches used for the evaluation. The findings support the technical analysis methods investigated.

Brock et al. (1992) conducted a seminal empirical study to prove technical analysis profitability. The same work was extended by (Ma 2022), comparing the profitabilities of using the official closing price vs. the last tick price, based on data from Hong Kong from 2011 to 2018, and the results suggest that using the last tick price rather than the official closing price improves profitability significantly using technical analysis methods.

Ausloos and Ivanova (2002) recalled the traditional technical analysis methods of stock evolution. Momentum indicators are used to predict the direction of a market trend and so provide signals before the trend changes. As a result, a typical technical analysis investing plan is sketched.

In his study, (Zulkarnain 2014) sought to see whether SMA technical analysis can be used to forecast top gainers' stock prices on the Indonesia Stock Exchange (IDX). He concluded that the difference between forecasted and actual prices is not significant. As a result, technical analysis is still a valuable tool for financial forecasting. (Wong et al. 2010) focused on the importance of technical analysis in determining when to enter and exit the stock market. The results show that the indicators used can achieve a high positive return. Singapore Stock Exchange (SES) member firms have been found to rely heavily on technical analysis, which has resulted in big profits. Hence, technical analysis seems to be an ideal approach to select some of its techniques and try to propose a new model based on it in order to improve the investor's predictive potential. Our EDWA falls into this forecast category.

### 3. Materials and Methods

The EDWA forecasting method is a mix of WMA and ES, but differs in the weighting and time period used. There is no specific time period here, as the method uses all available data starting with the current value up to day 1 and it gives a higher weight to the current value and the next value; this is similar to WMA but goes back to day 1. However, to emphasize the importance of the most recent values, we propose assigning a weight that is weighted twice as much as the previous value, so the method becomes almost similar to ES in terms of the weighting system.

EDWA usually assigns a certain initial weight to the final price, which is set to 2 by default, and this weight is reduced in half (exponential decrease) with each subsequent price. In other words, the current price is weighted with 2, the previous day weighted with 2/2, the previous day with 1/2 and so on up to day 1. This is why it is known as the exponentially decaying weighted average.

It is worth noting that if the time series is lengthy, the decaying weight may approach 0 due to the precision of floating point on today's computers. To get around this issue, EDWA applies the lowest weight possible to all deeper prices in the time series. The EDWA formula is as follows:

$$EDWA(t + 1) = \frac{w_1 p_t + w_2 p_{t-1} + w_3 p_{t-2} + \dots + w_n p_{t-n+1}}{w_1 + w_2 + w_3 + \dots + w_n} \tag{1}$$

where  $w_1 = 2, w_2 = \frac{w_1}{2}, w_3 = \frac{w_2}{2}, \dots, w_n = \frac{w_{n-1}}{2}$ ,  $n$  is the number of days or prices in the time series,  $p_t$  is the current price,  $p_{t-1}$  is the previous price, and  $p_{t-n+1}$  is the oldest price.

The SMA is defined by

$$F_{n+1} = \frac{1}{k} \sum_{t=n}^{n-k} P_t$$

WMA is defined by

$$F_{n+1} = \frac{1}{k} \sum_{t=n}^{n-k} w_t * P_t$$

ES is defined by

$$F_{n+1} = a * P_t + (1 - a) * F_t$$

where  $F_{n+1}$  is the forecasted value,  $P_t$  is the actual price of the share at time (day)  $t$ ,  $k$  is the number of concerned days,  $w$  is the weighting factors and  $a$  is a smoothing constant.

To obtain the general trend of the share price of our sample study, we propose the use of the average of the averages of all periods, starting with the current price and going back by one day each time to obtain  $n$  averages, where  $n$  is the size of the time series, then we divide the sum of these averages by  $n$ , as formulated by

$$\text{Avgavg}(n + 1) = \frac{\sum_{i=n}^1 \left( \frac{\sum_{j=i}^n P_j}{n-i+1} \right)}{n} \tag{2}$$

where  $\text{Avgavg}(n + 1)$  is the forecasted price of a time series of size =  $n$  based on the average of the averages of all previous prices.

The chosen technical analysis methods, namely EDWA, SMA, WMA, and ES, were applied to the time series datasets of the Jordanian insurance companies for forecasting. These methods were compared based on their forecasting results. To measure the forecasting error of each method we opt for some of the well-known error indicators, namely MAE, MSE, MPE, MAPE, and TS (Lei 2017; Haji Rahimi and Khashei 2018).

Since all of these indicators are based on the forecasting error, we define the forecast error as

$$E(t) = P(t) - F(t)$$

where  $E(t)$  is the forecasting error at time  $t$  (on our case day),  $P(t)$  is the actual share price, and  $F(t)$  is the forecasted price at the same  $t$ . Consequently, the Absolute forecasting error (AE) is defined by

$$AE(t) = |E(t)|$$

the Percent Error (PE) is defined by

$$PE(t) = \frac{E(t)}{P(t)}$$

and the Absolute Percent Error (APE) is defined by

$$APE(t) = \frac{AE(t)}{P(t)}$$

Accordingly, we can define the error measures of forecasting as

$$MAE = \frac{1}{n} \sum_{t=1}^n AE(t)$$

$$MSE = \frac{1}{n} \sum_{t=1}^n E(t)^2$$

$$MPE = \frac{1}{n} \sum_{t=1}^n PE(t)$$

$$MAPE = \frac{1}{n} \sum_{t=1}^n APE(t)$$

and

$$TS = \frac{\frac{1}{n} \sum_{t=1}^n E(t)}{MAE}$$

where  $n$  is the number of forecasted prices, in this work, it is equal to the size of the time series minus 1, since we are going to forecast all prices from day 1 through day  $n$  (the current price) in order to be able to use a ground-Compare truth price to calculate forecast error.

To forecast the stock price of Jordanian insurance companies during COVID-19, we collected the daily closing prices of 10 Jordanian insurance companies, out of 20 insurance companies, because there was not enough publicly available data for the rest of the other 10 companies. The data were collected from the official website of the Amman Stock Exchange (<https://www.ase.com.jo/>, accessed on 1 November 2021). Such online systems' data sources are typically historical stock prices and/or technical indicators derived from a time series examination of stock prices (Chourmouziadis and Chatzoglou 2016; Kimoto et al. 1990; Qian and Rasheed 2007). The period of the prices of each company starts from January 2018 to November 2021. Thus, we covered two distinct periods: the COVID-19 pandemic period (2020–2021), and the non-pandemic period (2018–2019).

For the sake of simplicity, we restricted the data to the daily closing prices. Each time series consists of 51 to 220 closing prices, this is all available data retrieved from the official Amman Stock Exchange website for the past four years. Table 2 shows the 10 Jordanian insurance companies investigated in this study. Table 3 shows some basic statistics of the insurance companies chosen.

**Table 2.** Description of the study sample.

Company's Name	Symbol	Average Value Traded	Average No. of Trans	Listed Shares	Available Data (Days)
Middle East Insurance	MEIN	37,853.6	3.1	22,050,000	144
Al-Nisr Al-Arabi Insurance	AAIN	2355.4	1.6	10,000,000	111
Jordan Insurance	JOIN	8144.8	3.7	30,000,000	143
Arabia Insurance Company-Jordan	AICJ	2425.5	2.5	8,000,000	178
Delta Insurance	DICL	3931.5	2.2	8,000,000	142
Jerusalem Insurance	JERY	1780.1	1.8	8,000,000	57
The United Insurance	UNIN	10,320.0	1.9	8,000,000	51
Jordan French Insurance	JOFR	3165.5	2.1	9,100,000	220
Al-Manara Insurance Plc.Co.	ARSI	30,751.92	2.95	5,600,000	147
Arab Orient Insurance Company	AOIC	1748.47	2.75	21,438,252	168

**Table 3.** Basic statistics of the study sample. All prices in Jordan Dinar.

Company	Market Capitalization	High Price	Low Price	Closing Price	Average Price	Value Traded	Turnover Ratio	Dividend	EPS
MEIN	22,050,000	1.45	1.13	1.28	1	6,795,941	24	0.050	0.046
AAIN	10,000,000	5	4	4	4	246,972	1	0.300	0.306
JOIN	30,000,000	2.33	1.1	1.42	1.44	478,096	1.11	0.000	0.100
AICJ	8,000,000	1	1	1	1	1,425,692	20	0.000	0.078
DICL	8,000,000	1	1	1	1	30,124	0	0.050	0.076
JERY	8,000,000	2	2	2	2	19,067	0	0.070	0.156
UNIN	8,000,000	1	1	1	1	282,431	3	0.100	0.188
JOFR	9,100,000	1	1	1	1	59,437	1	0.000	0.100
ARSI	5,600,000	1	0	0	0	194,495	8	0.000	0.317
AOIC	25,438,252	1.63	1.14	1.55	1	66,046	0	0.000	0.265

#### 4. Results and Discussion

For the forecast, the chosen technical analysis methods EDWA, SMA, WMA, and ES were first applied to one of the time series datasets of the Jordanian insurance companies, namely MEIN. Figures 1–4 illustrate the forecast results for each method.



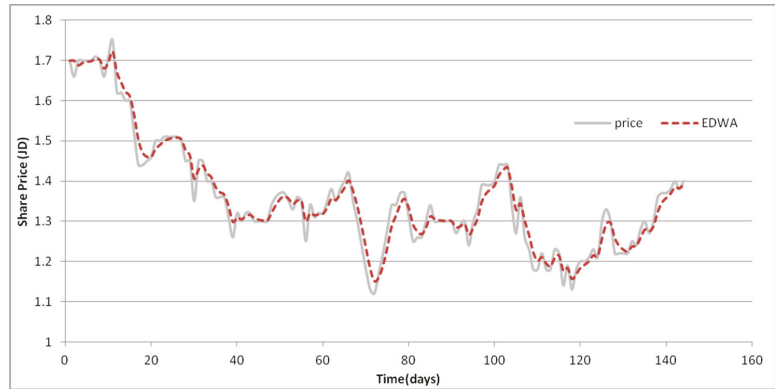


Figure 1. Forecasting results of MEIN using EDWA.

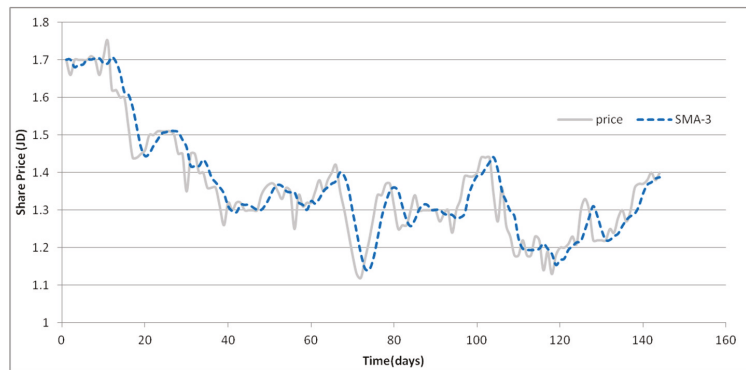


Figure 2. Forecasting results of MEIN using SMA on 3 days period.

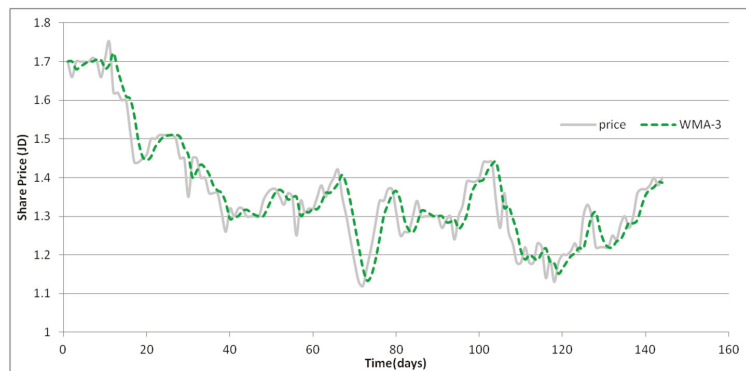


Figure 3. Forecasting results of MEIN using WMA on 3 days period.

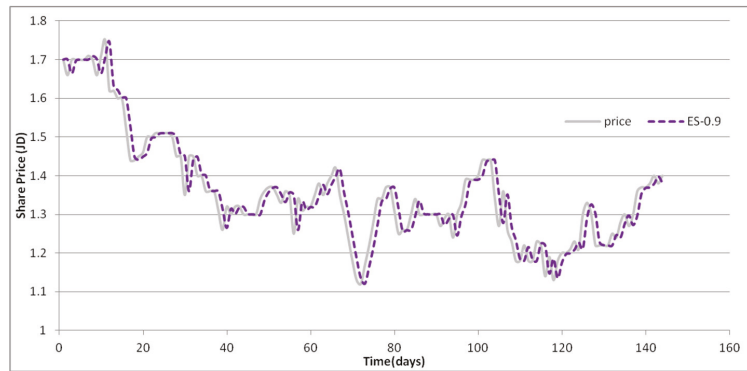


Figure 4. Forecasting results of MEIN using ES, with alpha = 0.9.

If we examine the curves in Figures 1–4, we can see that both EDWA and ES have significantly higher forecasting performance than SMA and WMA. Perhaps such a solid performance is due to the inclusion of all prices in the time series that both EDWA and ES enable. Although both SMA and WMA used only three days more, the outcomes were not comparable. However, to support this conclusion, we need to apply these approaches to of the all Jordanian insurance companies’ datasets, gather measures of error for a fair comparison, and determine which technical analysis methods are most suited to our data. Tables 4–6 show the measures of error after forecasting all 10 datasets using the four technical analysis methods.

Table 4. Forecast errors of technical analysis methods on MEIN, AAIN, JOIN, and AICJ. Bold values signify the minimum error.

CN	Method	MAE	MAPE	MPE	MSE	TS	CN	Method	MAE	MAPE	MPE	MSE	TS
MEIN	EDWMA	<b>0.018</b>	<b>0.014</b>	<b>0.002</b>	<b>0.001</b>	0.125	AAIN	EDWMA	<b>0.021</b>	<b>0.005</b>	<b>−0.001</b>	<b>0.002</b>	−0.189
	SMA-3	0.038	0.029	0.004	0.003	0.11		SMA-3	0.044	0.011	−0.002	0.007	−0.184
	WMA-3	0.047	0.033	−0.004	0.022	−0.174		WMA-3	0.074	0.018	−0.01	0.15	−0.577
	ES-0.1	0.062	0.047	0.021	0.006	0.423		ES-0.1	0.114	0.028	−0.005	0.023	−0.235
	ES-0.5	0.036	0.027	0.004	0.002	0.119		ES-0.5	0.043	0.011	−0.002	0.006	−0.189
	ES-0.9	0.03	0.023	0.002	0.002	<b>0.077</b>		ES-0.9	0.028	0.007	<b>−0.001</b>	0.005	<b>−0.172</b>
	SMA-10	0.056	0.042	0.01	0.006	0.216		SMA-10	0.097	0.024	−0.004	0.017	−0.212
	WMA-10	0.142	0.091	−0.048	0.164	−0.602		WMA-10	0.362	0.09	−0.075	1.172	−0.839
	SMA-20	0.071	0.053	0.021	0.008	0.37		SMA-20	0.762	0.186	−0.165	2.74	−0.893
WMA-20	0.252	0.164	−0.116	0.332	−0.761	WMA-20	0.762	0.186	−0.165	2.74	−0.893		
JOIN	EDWMA	<b>0.034</b>	<b>0.019</b>	<b>0</b>	<b>0.003</b>	−0.059	AICJ	EDWMA	<b>0.008</b>	<b>0.013</b>	<b>0.002</b>	<b>0</b>	0.096
	SMA-3	0.071	0.04	<b>0</b>	0.012	−0.055		SMA-3	0.016	0.028	0.003	<b>0</b>	0.106
	WMA-3	0.072	0.041	−0.007	0.026	−0.197		WMA-3	0.019	0.031	−0.003	0.004	−0.148
	ES-0.1	0.207	0.121	0.016	0.086	−0.079		ES-0.1	0.03	0.051	0.014	0.001	0.243
	ES-0.5	0.068	0.038	<b>0</b>	0.011	−0.059		ES-0.5	0.016	0.027	0.003	<b>0</b>	0.107
	ES-0.9	0.045	0.026	−0.001	0.005	<b>−0.048</b>		ES-0.9	0.014	0.023	0.002	<b>0</b>	<b>0.069</b>
	SMA-10	0.154	0.086	0.004	0.057	−0.076		SMA-10	0.027	0.045	0.009	0.001	0.163
	WMA-10	0.205	0.122	−0.055	0.168	−0.466		WMA-10	0.053	0.081	−0.04	0.024	−0.565
	SMA-20	0.25	0.143	0.013	0.135	−0.1		SMA-20	0.034	0.058	0.013	0.002	0.191
WMA-20	0.383	0.23	−0.118	0.394	−0.56	WMA-20	0.091	0.143	−0.099	0.045	−0.734		

**Table 5.** Forecast errors of technical analysis methods on DICL, JOFR, JERY and UNIN. Bold values signify the minimum error.

CN	Method	MAE	MAPE	MPE	MSE	TS	CN	Method	MAE	MAPE	MPE	MSE	TS
DICL	EDWMA	<b>0.057</b>	<b>0.028</b>	0.013	<b>0.013</b>	0.393	JOFR	EDWMA	<b>0.01</b>	<b>0.012</b>	<b>0.001</b>	<b>0</b>	0.015
	SMA-3	0.124	0.06	0.026	0.059	0.364		SMA-3	0.022	0.026	0.001	0.001	0.012
	WMA-3	0.141	0.059	0.015	0.202	<b>0.046</b>		WMA-3	0.025	0.028	-0.003	0.005	-0.166
	ES-0.1	0.326	0.183	0.14	0.198	0.688		ES-0.1	0.037	0.042	0.004	0.002	0.023
	ES-0.5	0.114	0.056	0.026	0.05	0.396		ES-0.5	0.02	0.023	0.001	0.001	0.013
	ES-0.9	0.091	0.042	0.014	0.036	0.276		ES-0.9	0.018	0.021	0.001	0.001	<b>0.008</b>
	SMA-10	0.241	0.127	0.076	0.147	0.538		SMA-10	0.029	0.033	0.002	0.002	0.026
	WMA-10	0.443	0.152	<b>-0.001</b>	1.334	-0.376		WMA-10	0.061	0.065	-0.034	0.036	-0.571
	SMA-20	0.39	0.217	0.147	0.277	0.626		SMA-20	0.041	0.047	0.005	0.003	0.045
	WMA-20	0.705	0.263	-0.045	2.028	-0.526		WMA-20	0.113	0.118	-0.077	0.083	-0.699
JERY	EDWMA	<b>0.019</b>	<b>0.012</b>	<b>0.001</b>	<b>0.001</b>	0.015	UNIN	EDWMA	<b>0.026</b>	<b>0.022</b>	0.008	<b>0.001</b>	0.391
	SMA-3	0.042	0.026	0.001	0.003	0.017		SMA-3	0.054	0.045	0.016	0.004	0.35
	WMA-3	0.067	0.041	-0.016	0.053	-0.432		WMA-3	0.08	0.06	<b>-0.006</b>	0.055	<b>-0.182</b>
	ES-0.1	0.049	0.031	0.005	0.005	0.127		ES-0.1	0.117	0.1	0.082	0.02	0.816
	ES-0.5	0.039	0.024	0.001	0.003	0.02		ES-0.5	0.051	0.042	0.016	0.004	0.376
	ES-0.9	0.031	0.019	0.001	0.003	0.018		ES-0.9	0.046	0.038	0.009	0.003	0.24
	SMA-10	0.053	0.032	0.002	0.004	0.021		SMA-10	0.082	0.069	0.038	0.011	0.543
	WMA-10	0.278	0.167	-0.14	0.397	-0.848		WMA-10	0.276	0.202	-0.139	0.328	-0.744
	SMA-20	0.057	0.035	0.002	0.006	<b>0.002</b>		SMA-20	0.112	0.096	0.068	0.018	0.703
	WMA-20	0.551	0.336	-0.32	0.856	-0.956		WMA-20	0.489	0.386	-0.347	0.59	-0.912

**Table 6.** Forecast errors of technical analysis methods on ARSI and AOIC. Bold values signify the minimum error.

CN	Method	MAE	MAPE	MPE	MSE	TS	CN	Method	MAE	MAPE	MPE	MSE	TS
ARSI	EDWMA	<b>0.009</b>	<b>0.019</b>	<b>0</b>	<b>0</b>	-0.019	AOIC	EDWMA	<b>0.019</b>	<b>0.017</b>	<b>-0.002</b>	<b>0.001</b>	-0.161
	SMA-3	0.019	0.041	0.001	0.001	-0.018		SMA-3	0.039	0.036	-0.004	0.002	-0.152
	WMA-3	0.019	0.042	-0.007	0.001	-0.161		WMA-3	0.041	0.039	-0.009	0.007	-0.268
	ES-0.1	0.033	0.071	0.002	0.002	-0.078		ES-0.1	0.071	0.065	-0.011	0.008	-0.28
	ES-0.5	0.017	0.037	0.001	<b>0</b>	-0.02		ES-0.5	0.037	0.034	-0.003	0.002	-0.157
	ES-0.9	0.013	0.028	<b>0</b>	<b>0</b>	<b>-0.012</b>		ES-0.9	0.031	0.028	-0.002	0.001	<b>-0.117</b>
	SMA-10	0.031	0.068	0.001	0.002	-0.061		SMA-10	0.066	0.06	-0.008	0.006	-0.217
	WMA-10	0.044	0.108	-0.057	0.008	-0.497		WMA-10	0.093	0.093	-0.057	0.042	-0.602
	SMA-20	0.039	0.083	-0.002	0.003	-0.12		SMA-20	0.084	0.077	-0.015	0.011	-0.303
	WMA-20	0.074	0.183	-0.124	0.019	-0.658		WMA-20	0.159	0.166	-0.123	0.09	-0.733

Interestingly, EDWMA scored the fewest errors of the most commonly used error indicators, followed by ES when  $\alpha = 0.09$  was used, as can be seen in Tables 4–6. Even when SMA and WMA were used at various time intervals, both EDWMA and ES methods perform much better in terms of few errors and highly accurate forecasting. If the TS error indicator is major concern, the ES outperforms almost all methods, although the error difference is not significant when compared to EDWMA. These findings confirm our contention that it is better to incorporate all historical data when using a technical analysis tool.

ES appears to favor a certain value ( $\alpha = 0.9$ ) (Chopra and Meindl 2013; Paul 2011), and hence requires parameter adjustment before being used in practice, whereas EDWMA is a non-parametric technique that does not require parameter input prior to the forecasting process. The EDWMA provides good forecasting for Jordanian insurance companies because it is a non-parametric method that outperforms all other methods on all datasets as shown by most error measures used.

We looked at the use of EDWMA and ES for forecasting share prices before and after the pandemic because they were the top forecasters. Tables 7 and 8 show the forecasting results.

**Table 7.** Forecast errors of EDWNA and ES on data from all companies tested before the pandemic. Bold values signify the minimum error within this table, and highlighted values signify the minimum error between Tables 7 and 8.

CN	Method	MAE	MAPE	MPE	MSE	TS	CN	Method	MAE	MAPE	MPE	MSE	TS
MEIN	EDWMA	0.018	<b>0.014</b>	<b>0.002</b>	<b>0.001</b>	0.125	AAIN	EDWMA	<b>0.017</b>	<b>0.004</b>	<b>0.001</b>	<b>0.001</b>	0.247
	ES-0.9	<b>0.007</b>	0.027	0.019	0.005	<b>0.002</b>		ES-0.9	0.024	0.006	<b>0.001</b>	0.004	<b>0.196</b>
JOIN	EDWMA	<b>0.029</b>	<b>0.013</b>	<b>−0.009</b>	<b>0.002</b>	−0.696	AICJ	EDWMA	<b>0.009</b>	<b>0.015</b>	<b>0.003</b>	<b>0.000</b>	0.153
	ES-0.9	0.036	0.017	−0.011	0.003	−0.630		SMA-3	0.016	0.025	0.003	<b>0.000</b>	<b>0.116</b>
DICL	EDWMA	<b>0.013</b>	<b>0.015</b>	<b>0.007</b>	<b>0.000</b>	0.447	JOFR	EDWMA	<b>0.007</b>	<b>0.009</b>	<b>0.002</b>	<b>0.000</b>	0.200
	ES-0.9	0.018	0.020	<b>0.007</b>	0.001	<b>0.302</b>		SMA-3	0.013	0.016	0.002	<b>0.000</b>	<b>0.120</b>
JERY	EDWMA	<b>0.020</b>	<b>0.013</b>	<b>0.003</b>	<b>0.001</b>	0.192	UNIN	EDWMA	<b>0.032</b>	<b>0.025</b>	<b>0.016</b>	<b>0.002</b>	0.629
	ES-0.9	0.036	0.022	0.004	0.003	<b>0.144</b>		SMA-3	0.054	0.043	<b>0.016</b>	0.005	<b>0.370</b>
ARSI	EDWMA	<b>0.010</b>	<b>0.022</b>	<b>0.000</b>	<b>0.000</b>	−0.041	AOIC	EDWMA	<b>0.018</b>	<b>0.018</b>	<b>−0.001</b>	<b>0.000</b>	−0.080
	ES-0.9	0.014	0.032	<b>0.000</b>	<b>0.000</b>	<b>−0.035</b>		SMA-3	0.031	0.030	<b>−0.001</b>	0.001	<b>−0.051</b>

**Table 8.** Forecast errors of EDWMA and ES on data from all companies tested after the pandemic. Bold values signify the minimum error within this table, and highlighted values signify the minimum error between Tables 7 and 8.

CN	Method	MAE	MAPE	MPE	MSE	TS	CN	Method	MAE	MAPE	MPE	MSE	TS
MEIN	EDWMA	0.019	<b>0.015</b>	<b>0.001</b>	<b>0.001</b>	0.052	AAIN	EDWMA	<b>0.022</b>	<b>0.005</b>	<b>−0.002</b>	<b>0.002</b>	−0.509
	ES-0.9	<b>0.001</b>	0.032	0.025	<b>0.001</b>	<b>0.002</b>		ES-0.9	0.028	0.007	−0.003	0.004	<b>−0.467</b>
JOIN	EDWMA	<b>0.034</b>	<b>0.021</b>	<b>0.004</b>	<b>0.003</b>	0.195	AICJ	EDWMA	<b>0.007</b>	<b>0.012</b>	<b>0.001</b>	<b>0.000</b>	0.048
	ES-0.9	0.047	0.030	<b>0.004</b>	0.005	<b>0.158</b>		SMA-3	0.012	0.021	<b>0.001</b>	<b>0.000</b>	<b>0.028</b>
DICL	EDWMA	<b>0.022</b>	<b>0.020</b>	<b>−0.007</b>	<b>0.001</b>	−0.384	JOFR	EDWMA	<b>0.015</b>	<b>0.016</b>	<b>−0.001</b>	<b>0.000</b>	−0.083
	ES-0.9	0.035	0.031	<b>−0.007</b>	0.002	<b>−0.245</b>		SMA-3	0.026	0.029	<b>−0.001</b>	0.001	<b>−0.061</b>
JERY	EDWMA	<b>0.017</b>	<b>0.010</b>	<b>−0.003</b>	<b>0.001</b>	−0.292	UNIN	EDWMA	<b>0.021</b>	<b>0.019</b>	<b>0.004</b>	<b>0.001</b>	0.154
	ES-0.9	0.026	0.015	<b>−0.003</b>	0.002	<b>−0.203</b>		SMA-3	0.034	0.031	<b>0.004</b>	0.002	<b>0.102</b>
ARSI	EDWMA	<b>0.007</b>	<b>0.014</b>	<b>0.001</b>	<b>0.000</b>	0.069	AOIC	EDWMA	<b>0.019</b>	<b>0.016</b>	<b>−0.003</b>	<b>0.001</b>	−0.248
	ES-0.9	0.010	0.021	0.002	<b>0.000</b>	<b>0.068</b>		SMA-3	0.030	0.025	−0.004	<b>0.001</b>	<b>−0.198</b>

Tables 7 and 8 show that both EDWMA and ES have good forecasting performance on insurance company price shares both before and after the pandemic. This demonstrates that technical analysis approaches are a suitable fit for such scenarios, and this finding is consistent with earlier research (Wong et al. 2010; Taylor and Allen 1992; Mitra 2011; Ausloos and Ivanova 2002; Vasiliou et al. 2006; Ma 2022), for example.

It is worth noticing that the EDWMA performed better before and after the epidemic on most datasets. Another interesting observation is the forecasting error before and after the pandemic. We can see that forecasting errors for some companies, such as JERY, ARSI, AICJ, UNIN, and MEIN decreased after the pandemic. This could be due to the nature of stock prices being more predictable after the major effect of the pandemic.

Other companies, such as DICL, AAIN, and AOIC, on the other hand, have marginally better forecasting outcomes prior to the pandemic. Additionally, two companies, JOIN and JOFR, demonstrate no substantial difference in forecasting performance before and after the pandemic. As a result, we cannot generalize the impact of the COVID-19 pandemic on Jordan's insurance business in terms of forecasting results (before and after) because each company has its own set of conditions.

To investigate the trend of the share prices of the selected Jordanian insurance companies, we applied the proposed Avgavg equation. The results of the trends are shown in Figure 5.

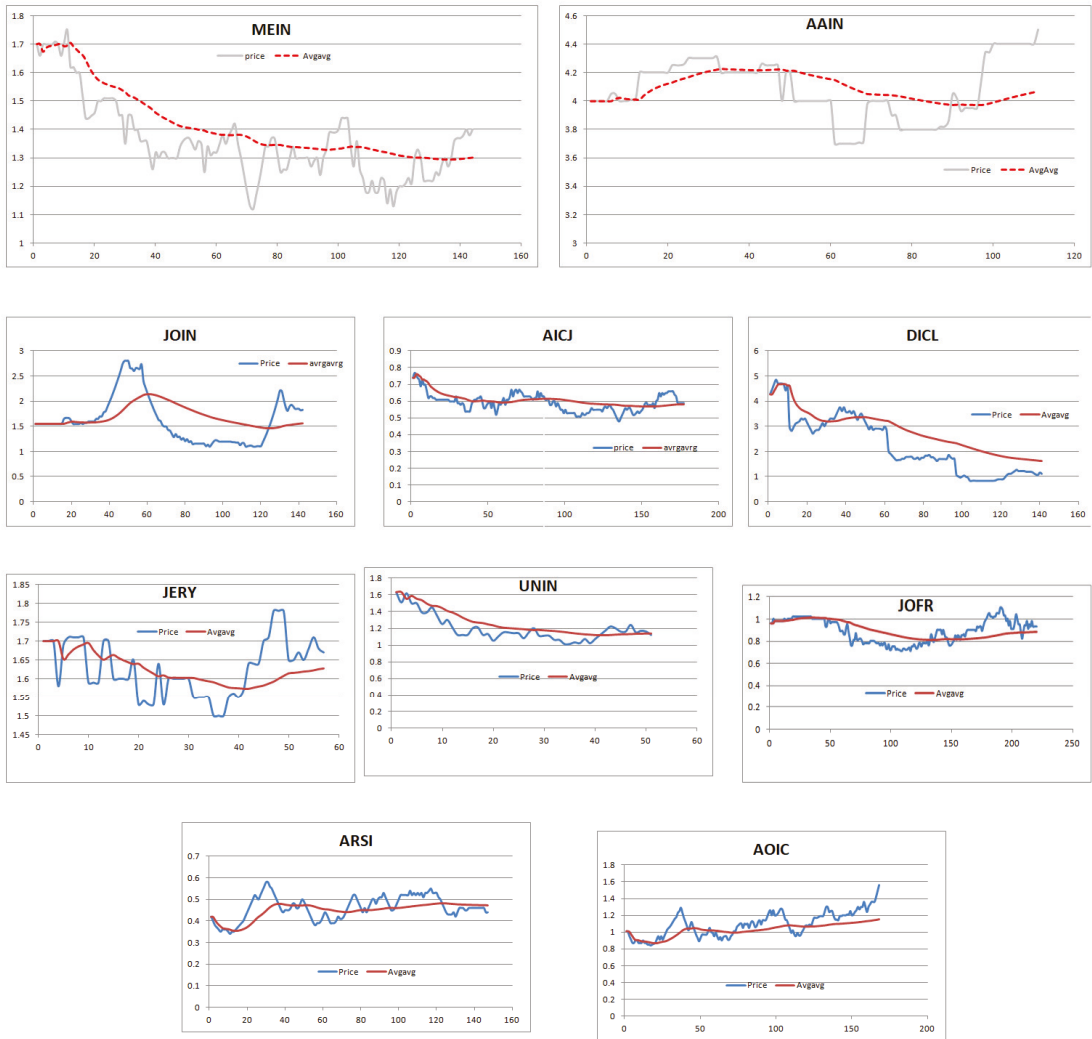


Figure 5. Avgavg trends approximation of share prices.

As shown in Figure 5, the Avgavg closely approximates share price trends. Most insurance companies started with a higher share price before the pandemic, which means that the pandemic partially hit the majority of the insurance companies surveyed. AOIC, on the other hand, is on a steady upward trajectory. Perhaps they found solutions to deal with the pandemic, or even profited from it. Additionally, if not increasing them, most companies stopped their share prices from falling, as they weathered the pandemic.

5. Conclusions

In this study, we used several technical analysis tools to forecast the share prices of a random sample of Jordanian insurance companies and examine their performance during the COVID-19 pandemic. The technical analysis tools used include parametric methods, namely SMA, WMA, ES, and one non-parametric method, our EDWMA, in addition to our trend approximation method, the Avgavg.

The experiments, which were conducted on the share prices of 10 Jordanian insurance companies, evaluated the forecasting performance against a range of error measures, including MAE, MAPE, MPE, MSE, and TS. The forecast results show that our EDWMA, followed by ES, are the best performers because of their reliance on all the historical prices. In contrast to EDWMA, the results show that the parametric methods must first be tuned before they can be used. This makes EDWMA the best choice for forecasting the datasets used. Moreover, the Avgavg interestingly exhibits the trends of the share prices of the analyzed companies and shows their performance in relation to the share prices before and after the COVID-19 pandemic.

The study has two limitations. First, due to a lack of publicly available data, the number of insurance companies tested was limited to ten, which represents half of the current insurance companies in Jordan. Second, we only employed a few common technical analysis approaches, ignoring a vast number of cutting-edge machine learning methods, such as deep learning forecasting methods. Our future research will concentrate on overcoming both limitations, particularly by integrating EDWMA with deep learning, as well as looking into more financial sectors.

**Author Contributions:** Conceptualization, G.A.A. and A.B.H.; methodology, G.A.A.; software, A.B.H.; validation, A.S.T., A.B.H. and A.A.; formal analysis, A.S.T.; investigation, A.A.; resources, A.A., M.A. (Malek Alrashidi), M.A. (Mansoor Alghamdi); data curation, A.A.; writing—original draft preparation, G.A.A., A.B.H., A.S.T., M.A. (Malek Alrashidi), M.A. (Mansoor Alghamdi) and A.A.; writing—review and editing, G.A.A., A.B.H., A.S.T., M.A. (Malek Alrashidi), M.A. (Mansoor Alghamdi) and A.A.; visualization, A.S.T.; supervision, A.B.H.; project administration, A.B.H. All authors have read and agreed to the published version of the manuscript.

**Funding:** This research received no external funding.

**Institutional Review Board Statement:** Not applicable.

**Informed Consent Statement:** Not applicable.

**Data Availability Statement:** All data used for the purpose of this study is available online at Amman stock exchange: <https://www.ase.com.jo>, accessed on 1 November 2021.

**Conflicts of Interest:** The authors declare no conflict of interest.

## References

- Abadleh, Ahmad, Bassam M. Al-Mahadeen, Rami M. AlNaimat, and Omar Lasassmeh. 2021. Noise segmentation for step detection and distance estimation using smartphone sensor data. *Wireless Networks* 27: 2337–46. [CrossRef]
- Abadleh, Ahmad, Eshraq Al-Hawari, Esra'a Alkafaween, and Hamad Al-Sawalqah. 2017. Step detection algorithm for accurate distance estimation using dynamic step length. Paper presented at the 2017 18th IEEE International Conference on Mobile Data Management (MDM), Daejeon, Korea, May 29–June 1.
- Abadleh, Ahmad, Sangyup Han, Soon Joo Hyun, Ben Lee, and Myungchul Kim. 2016. Construction of indoor floor plan and localization. *Wireless Networks* 22: 175–91. [CrossRef]
- Abarbanell, Jeffrey, and Brian J. Bushee. 1997. Fundamental Analysis, Future Earnings, and Stock Prices. *Journal of Accounting Research* 35: 1–24. [CrossRef]
- Abdallah, Wajih, Sami Mnasri, and Thierry Val. 2020a. Genetic-Voronoi algorithm for coverage of IoT data collection networks. Paper presented at the 30th International Conference on Computer Theory and Applications, ICCTA 2020, Alexandria, Egypt, December 2–14.
- Abdallah, Wajih, Sami Mnasri, Nejeh Nasri, and Thierry Val. 2020b. Emergent IoT Wireless Technologies beyond the year 2020: A Comprehensive Comparative Analysis. Paper presented at the 2020 International Conference on Computing and Information Technology (ICCIIT-1441), Tabuk, Saudi Arabia, September 9–10.
- Abuzuraiq, AlMaha, Mouhammd Alkasassbeh, and Muhammad Almseidin. 2020. Intelligent Methods for Accurately Detecting Phishing Websites. Paper presented at the 2020 11th International Conference on Information and Communication Systems, ICICS 2020, Irbid, Jordan, April 7–9.
- Agrawal, J. G., V. S. Chourasia, and A. K. Mittra. 2013. State-of-the-Art in Stock Prediction Techniques. *International Journal of Advanced Research in Electrical, Electronics and Instrumentation Engineering* 2: 1360–66.
- Alabadleh, Ahmad, Saqer Aljaafreh, Ahmad Aljaafreh, and Khaled Alawasa. 2018. A RSS-based localization method using HMM-based error correction. *Journal of Location Based Services* 12: 273–85. [CrossRef]

- Al-Btoush, Audi I., Mohammad A. Abbadi, Ahmad B. Hassanat, Ahmad S. Tarawneh, Asad Hasanat, and V. B. Surya Prasath. 2019. New Features for Eye-Tracking Systems: Preliminary Results. Paper presented at the 2019 10th International Conference on Information and Communication Systems (ICICS), Irbid, Jordan, June 11–13.
- Alghamdi, Mansoor, and William Teahan. 2017. Experimental evaluation of Arabic OCR systems. *PSU Research Review* 1: 229–41. [CrossRef]
- Aljaafreh, Ahmad, Khaled Alawasa, Saqer Alja'afreh, and Ahmad Abadleh. 2017. Fuzzy inference system for speed bumps detection using smart phone accelerometer sensor. *Journal of Telecommunication, Electronic and Computer Engineering* 9: 133–36.
- Al-kasassbeh, Mouhammd, and Tarek Khairallah. 2019. Winning tactics with DNS tunneling. *Network Security* 2019: 12–19. [CrossRef]
- Al-Kasassbeh, Mouhammd, Safaa Mohammed, Mohammad Alauthman, and Ammar Almomani. 2019. Feature selection using a machine learning to classify a malware. In *Handbook of Computer Networks and Cyber Security*. Cham: Springer, pp. 889–904.
- Alkasassbeh, Mouhammd. 2018. A novel hybrid method for network anomaly detection based on traffic prediction and change point detection. *Journal of Computer Science* 14: 1–11. [CrossRef]
- Almseidin, Mohamad, Imre Piller, Mouhammd Al-Kasassbeh, and Szilveszter Kovacs. 2019a. Fuzzy automaton as a detection mechanism for the multi-step attack. *International Journal on Advanced Science, Engineering and Information Technology* 9: 575–86. [CrossRef]
- Almseidin, Muhammad, AlMaha Abu Zuraiq, Mouhammd Al-kasassbeh, and Nidal Alnidami. 2019b. Phishing detection based on machine learning and feature selection methods. *International Journal of Interactive Mobile Technologies* 13: 171–83. [CrossRef]
- Almseidin, Muhammad, Mouhammd Al-Kasassbeh, and Szilveszter Kovacs. 2019c. Detecting Slow Port Scan Using Fuzzy Rule Interpolation. Paper presented at the 2019 2nd International Conference on New Trends in Computing Sciences, ICTCS 2019, Amman, Jordan, October 9–11.
- Al-Naymat, Ghazi, Mouhammd Al-Kasassbeh, and Eshraq Al-Hawari. 2018. Using machine learning methods for detecting network anomalies within SNMP-MIB dataset. *International Journal of Wireless and Mobile Computing* 15: 67–76. [CrossRef]
- Allothman, Zainab, Mouhammd Alkasassbeh, and Sherenaz Al-Haj Baddar. 2020. An efficient approach to detect IoT botnet attacks using machine learning. *Journal of High Speed Networks* 26: 1–14. [CrossRef]
- Alqatawneh, Alaa, Rania Alhalaseh, Ahmad Hassanat, and Mohammad Abbadi. 2019. Statistical-Hypothesis-Aided Tests for Epilepsy Classification. *Computers* 8: 84. [CrossRef]
- Al-Shamaileh, Mohammad Z., Ahmad B. Hassanat, Ahmad S. Tarawneh, MD Sohel Rahman, Ceyhun Celik, and Moohanad Jawthari. 2019. New Online/Offline text-dependent Arabic Handwriting dataset for Writer Authentication and Identification. Paper presented at the 2019 10th International Conference on Information and Communication Systems (ICICS), Irbid, Jordan, June 11–13; pp. 116–21.
- Altarawneh, Ghada. 2019. Prediction of Stock Price Using A Hybrid Technical Analysis Method. *Science International Lahore* 31: 391–96.
- AlTarawneh, Ragaad, Manal AlKhoshrman, Yousef Nabeel, Shah Rukh Humayoun, and Ahmad Hassanat. 2017. The Story of Designing an Educational Mobile Application for Children in South of Jordan. Paper presented at the 31st International BCS Human Computer Interaction Conference (HCI 2017), London, UK, July 3–6.
- Ausloos, Maecel, and Katrin Ivanova. 2002. Mechanistic approach to generalized technical analysis of share prices and stock market indices. *The European Physical Journal B-Condensed Matter and Complex Systems* 27: 177–87. [CrossRef]
- Bollen, Johan, Huina Mao, and Xiaojun Zeng. 2011. Twitter mood predicts the stock market. *Journal of Computational Science* 2: 1–8. [CrossRef]
- Brock, William, Josef Lakonishok, and Blake LeBaron. 1992. Simple technical trading rules and the stochastic properties of stock returns. *The Journal of Finance* 47: 1731–64. [CrossRef]
- Chen, Yuh-Jen, and Yuh-Min Chen. 2013. A fundamental analysis-based method for stock market forecasting. Paper presented at the 2013 International Conference on Intelligent Control and Information Processing, ICICIP 2013, Dali, China, June 9–11.
- Chen, Yuh-Jen, Yuh-Min Chen, and Chang Lin Lu. 2017. Enhancement of stock market forecasting using an improved fundamental analysis-based approach. *Soft Computing* 21: 3735–57. [CrossRef]
- Chi, Wan Le. 2018. Stock price forecasting based on time series analysis. In *AIP Conference Proceedings*. New York: AIP Publishing LLC.
- Chopra, Sunil, and Peter Meindl. 2013. *Supply Chain Management: Strategy, Planning, and Operation*, 5th ed. Hoboken: Prentice Hall, p. 195.
- Chourmouziadis, Konstandinos, and Prodromos D. Chatzoglou. 2016. An intelligent short term stock trading fuzzy system for assisting investors in portfolio management. *Expert Systems with Applications* 43: 298–311. [CrossRef]
- Chowdhury, Reaz, M. R. Mahdy, Tanisha N. Alam, Golam D. Al Quaderi, and M. Arifur Rahman. 2020. Predicting the stock price of frontier markets using machine learning and modified Black–Scholes Option pricing model. *Physica A: Statistical Mechanics and Its Applications* 555: 124444. [CrossRef]
- De Voogt, Alex, Ahmad Hassanat, and Mahmoud Alhasanat. 2017. The history and distribution of tab: A survey of Petra's gaming boards. *Journal of Near Eastern Studies* 76: 93–101. [CrossRef]
- Drakopoulou, Veliota. 2016. A Review of Fundamental and Technical Stock Analysis Techniques. *Journal of Stock & Forex Trading* 5: 1–8.
- Edwards, Robert, John Magee, and W. H. Bassetti. 2012. *Technical Analysis of Stock Trends*. Boca Raton: CRC Press.
- Eyal Salman, Hamzeh, Abdelhak-Djamel Seriai, and Christophe Dony. 2015. Feature-level change impact analysis using formal concept analysis. *International Journal of Software Engineering and Knowledge Engineering* 25: 69–92. [CrossRef]

- Eyal Salman, Hamzeh. 2017. Identification multi-level frequent usage patterns from APIs. *Journal of Systems and Software* 130: 42–56. [\[CrossRef\]](#)
- Fama, Eugene, Lawrence Fisher, Michael Jensen, and Richard Roll. 1969. The adjustment of stock prices to new information. *International Economic Review* 10: 1–21. [\[CrossRef\]](#)
- Fama, Eugene. 1965. The behavior of stock-market prices. *The Journal of Business* 38: 34–105. [\[CrossRef\]](#)
- Fama, Eugene. 1995. Random walks in stock market prices. *Financial Analysts Journal* 51: 75–80. [\[CrossRef\]](#)
- Fikru, Mahelet. 2019. Estimated electricity bill savings for residential solar photovoltaic system owners: Are they accurate enough? *Applied Energy* 253: 113501. [\[CrossRef\]](#)
- Ghatasheh, Nazeeh, Hossam Faris, Ruba Abukhurma, Pedro Castillo, Nailah Al-Madi, Antonio Mora, Ala Al-Zoubi, and Ahmad Hassanat. 2020. Cost-sensitive ensemble methods for bankruptcy prediction in a highly imbalanced data distribution: A real case from the Spanish market. *Progress in Artificial Intelligence* 9: 361–75. [\[CrossRef\]](#)
- Haji Rahimi, Zahra, and Mehdi Khashei. 2018. A least squares-based parallel hybridization of statistical and intelligent models for time series forecasting. *Computers & Industrial Engineering* 118: 44–53.
- Hamadaqa, Emad, Ahmad Abadleh, Ayoub Mars, and Wael Adi. 2019. Highly Secured Implantable Medical Devices. Paper presented at the International Conference on Innovations in Information Technology (IIT), Al Ain, United Arab Emiratespp, November 7–12.
- Hassanat, Ahmad B., and Ahmad Tarawneh. 2016. Fusion of color and statistic features for enhancing content-based image retrieval systems. *Journal of Theoretical and Applied Information Technology* 88: 644–55.
- Hassanat, Ahmad B. 2018a. Furthest-Pair-Based Binary Search Tree for Speeding Big Data Classification Using K-Nearest Neighbors. *Big Data* 6: 225–35. [\[CrossRef\]](#)
- Hassanat, Ahmad B. 2018b. Furthest-Pair-Based Decision Trees: Experimental Results on Big Data Classification. *Information* 9: 284. [\[CrossRef\]](#)
- Hassanat, Ahmad B. 2018c. Norm-Based Binary Search Trees for Speeding Up KNN Big Data Classification. *Computers* 7: 54. [\[CrossRef\]](#)
- Hassanat, Ahmad B. 2018d. Two-point-based binary search trees for accelerating big data classification using KNN. *PLoS ONE* 13: e0207772. [\[CrossRef\]](#)
- Hassanat, Ahmad B. 2018e. On Identifying Terrorists Using Their Victory Signs. *Data Science Journal* 17: 27. [\[CrossRef\]](#)
- Hassanat, Ahmad B., Ahmad S. Tarawneh, Samer Subhi Abed, Ghada Awad Altarawneh, Malek Alrashidi, and Mansoor Alghamdi. 2022. RDPVR: Random Data Partitioning with Voting Rule for Machine Learning from Class-Imbalanced Datasets. *Electronics* 11: 228. [\[CrossRef\]](#)
- Hassanat, Ahmad B., and Ghada Altarawneh. 2014. Rule-and dictionary-based solution for variations in written Arabic names in social networks, big data, accounting systems and large databases. *Research Journal of Applied Sciences, Engineering and Technology* 8: 1630–38. [\[CrossRef\]](#)
- Hassanat, Ahmad B., and Sabah Jassim. 2010. Visual words for lip-reading. In *Proceedings of SPIE*. Bellingham: The International Society for Optical Engineering, vol. 7708.
- Hassanat, Ahmad B., Ghada Altarawneh, Ahmad S. Tarawneh, Hossam Faris, Mahmoud B. Alhasanat, Alex de Voogt, Bakir Al-Rawashdeh, Muhammad Alshamailah, and Surya V. B. Prasath. 2018a. On Computerizing the Ancient Game of Tab. *International Journal of Gaming and Computer-Mediated Simulations* 10: 20–40. [\[CrossRef\]](#)
- Hassanat, Ahmad B., Mouhammd Alkasassbeh, Mouhammd Al-awadi, and Esra'a Alhasanat. 2015a. Color-based object segmentation method using artificial neural network. *Simulation Modelling Practice and Theory* 64: 3–17. [\[CrossRef\]](#)
- Hassanat, Ahmad B., Mouhammd Alkasassbeh, Mouhammd Al-Awadi, and Esra'a Alhasanat. 2015b. Colour-based lips segmentation method using artificial neural networks. Paper presented at the 2015 6th International Conference on Information and Communication Systems (ICICS), Irbid, Jordan, April 7–9.
- Hassanat, Ahmad B., Muhammad Al-Awadi, Eman Btoush, Amani Al-Btoush, Esraa Alhasanat, and Ghada Altarawneh. 2015c. New mobile phone and webcam hand images databases for personal authentication and identification. *Procedia Manufacturing* 3: 4060–67. [\[CrossRef\]](#)
- Hassanat, Ahmad B., Sami Mnasri, Mohammed Aseeri, Khaled Alhazmi, Omar Cheikhrouhou, Ghada Altarawneh, Malek Alrashidi, Ahmad S. Tarawneh, Khalid Almohammadi, and Hani Almoamari. 2021. A simulation model for forecasting covid-19 pandemic spread: Analytical results based on the current Saudi covid-19 data. *Sustainability* 13: 4888. [\[CrossRef\]](#)
- Hassanat, Ahmad B., V. S. Prasath, Bassam M. A. Mahadeen, and Samaher M. M. Alhasanat. 2017a. Classification and gender recognition from veiled-faces. *International Journal of Biometrics* 9: 347. [\[CrossRef\]](#)
- Hassanat, Ahmad B., V. S. Prasath, Khalil Mseidein, Muhammad Al-Awadi, and Awni Hammouri. 2017b. A hybrid wavelet-shearlet approach to robust digital image watermarking. *Informatica* 41: 1–13.
- Hassanat, Ahmad B., V. S. Prasath, Mouhammd Al-kasassbeh, Ahmad Tarawneh, and Ahmad Al-shamailh. 2018b. Magnetic energy-based feature extraction for low-quality fingerprint images. *Signal, Image and Video Processing* 12: 1471–78. [\[CrossRef\]](#)
- Sunny, Md Arif Istiake, Mirza Maswood, and Abdullah Alharbi. 2020. Deep Learning-Based Stock Price Prediction Using LSTM and Bi-Directional LSTM Model. Paper presented at the 2nd Novel Intelligent and Leading Emerging Sciences Conference, NILES 2020, Giza, Egypt, October 24–26.
- Khan, Ayaz. 2014. How does stock prices respond to various macroeconomic factors? A case study of Pakistan. *Journal of Management Info* 4: 75–95. [\[CrossRef\]](#)



- Khan, Wasiat, Usman Malik, Mustansar A. Ghazanfar, Muhammad Azam, Khaled Alyoubi, and Ahmed S. Alfakeeh. 2020. Predicting stock market trends using machine learning algorithms via public sentiment and political situation analysis. *Soft Computing* 24: 11019–43. [\[CrossRef\]](#)
- Khashei, Mehdi, and Zahra Hajirahimi. 2018. A comparative study of series arima/mlp hybrid models for stock price forecasting. *Communications in Statistics-Simulation and Computation* 48: 2625–40. [\[CrossRef\]](#)
- Kimoto, Takashi, Kazuo Asakawa, Morio Yoda, and Masakazu Takeoka. 1990. Stock market prediction system with modular neural networks. Paper presented at the 1990 IJCNN International Joint Conference on Neural Networks, San Diego, CA, USA, June 17–21; pp. 1–6.
- Lei, L. 2017. Wavelet Neural Network Prediction Method of Stock Price Trend Based on Rough Set Attribute Reduction. *Applied Soft Computing Journal* 62: 923–32. [\[CrossRef\]](#)
- Lin, Yu-Fei, Tzu-Ming Huang, Wei-Ho Chung, and Yeong-Luh Ueng. 2020. Forecasting Fluctuations in the Financial Index Using a Recurrent Neural Network Based on Price Features. *IEEE Transactions on Emerging Topics in Computational Intelligence* 5: 780–91. [\[CrossRef\]](#)
- Lo, Andrew, and A. Craig MacKinlay. 1988. Stock market prices do not follow random walks: Evidence from a simple specification test. *The Review of Financial Studies* 1: 41–66. [\[CrossRef\]](#)
- Ma, Alfred. 2022. Profitability of technical trading strategies under market manipulation. *Financial Innovation* 8: 1–9. [\[CrossRef\]](#)
- Malkiel, Burton. 2003. The efficient market hypothesis and its critics. *Journal of Economic Perspectives* 17: 59–82. [\[CrossRef\]](#)
- Mars, Ayoub, Ahmad Abadleh, and Wael Adi. 2019. Operator and Manufacturer Independent D2D Private Link for Future 5G Networks. Paper presented at the INFOCOM 2019—IEEE Conference on Computer Communications Workshops, INFOCOM WKSHPs 2019, Paris, France, April 29–May 2.
- Mehta, Pooja, Sharnil Pandya, and Ketan Kotecha. 2021. Harvesting social media sentiment analysis to enhance stock market prediction using deep learning. *PeerJ Computer Science* 7: e476. [\[CrossRef\]](#) [\[PubMed\]](#)
- Mitra, Subrata Kumar. 2011. How rewarding is technical analysis in the Indian stock market? *Quantitative Finance* 11: 287–97. [\[CrossRef\]](#)
- Mnasri, Sami, Adrien Van Den Bossche, Nejah Narsi, and Thierry Val. 2015. The 3D Deployment Multi-objective Problem in Mobile WSN: Optimizing Coverage and Localization. *International Research Journal of Innovative Engineering—IRJIE* 1: 1–15.
- Mnasri, Sami, Fatma Abbes, Kamel Zidi, and Khaled Ghedira. 2014. A multi-objective hybrid BCRC-NSGAI algorithm to solve the VRPTW. Paper presented at the 13th International Conference on Hybrid Intelligent Systems, HIS 2013, Gammarth, Tunisia, December 4–6.
- Mnasri, Sami, Adrien Van Den Bossche, Nejah Nasri, and Thierry Val. 2017a. The 3D Redeployment of Nodes in Wireless Sensor Networks with Real Testbed Prototyping. In *Lecture Notes in Computer Science (including subseries Lecture Notes in Artificial Intelligence and Lecture Notes in Bioinformatics)*. Cham: Springer, vol. 10517 LNCS.
- Mnasri, Sami, Nejah Nasri, Adrien Van Den Bossche, and Thierry Val. 2017b. A hybrid ant-genetic algorithm to solve a real deployment problem: A case study with experimental validation. In *Lecture Notes in Computer Science (including subseries Lecture Notes in Artificial Intelligence and Lecture Notes in Bioinformatics)*. Cham: Springer, vol. 10517 LNCS.
- Mnasri, Sami, Nejah Nasri, Adrien Van Den Bossche, and Thierry Val. 2018a. A comparative analysis with validation of NSGA-III and MOEA/D in resolving the 3D indoor redeployment problem in DL-IoT. Paper presented at the 2017 International Conference on Internet of Things, Embedded Systems and Communications, IINTEC 2017, Gafsa, Tunisia, October 20–22.
- Mnasri, Sami, Nejah Nasri, Adrien van den Bossche, and Thierry Val. 2019. A new multi-agent particle swarm algorithm based on birds accents for the 3D indoor deployment problem. *ISA Transactions* 91: 262–80. [\[CrossRef\]](#) [\[PubMed\]](#)
- Mnasri, Sami, Nejah Nasri, and Thierry Val. 2018b. The 3D indoor deployment in DL-IoT with experimental validation using a particle swarm algorithm based on the dialects of songs. Paper presented at the 2018 14th International Wireless Communications and Mobile Computing Conference, IWCMC 2018, Limassol, Cyprus, June 25–29.
- Mnasri, Sami, Nejah Nasri, Malek Alrashidi, Adrien van den Bossche, and Thierry Val. 2020. IoT networks 3D deployment using hybrid many-objective optimization algorithms. *Journal of Heuristics* 26: 663–709. [\[CrossRef\]](#)
- Muhammad, Shakeel. 2018. The Relationship Between Fundamental Analysis and Stock Returns Based on the Panel Data Analysis: Evidence from Karachi Stock exchange (KSE). *Research Journal of Finance and Accounting* 9: 84–96.
- Mulhem, Saleh, Ahmad Abadleh, and Wael Adi. 2019. Accelerometer-Based Joint User-Device Clone-Resistant Identity. Paper presented at the Second World Conference on Smart Trends in Systems, Security and Sustainability (WorldS4), London, UK, October 30–31; pp. 230–37.
- Nabipour, Mojtaba, Pooyan Nayyeri, Hamed Jabani, S. Shahab, and Amir Mosavi. 2020. Predicting Stock Market Trends Using Machine Learning and Deep Learning Algorithms Via Continuous and Binary Data; A Comparative Analysis. *IEEE Access* 8: 150199–212. [\[CrossRef\]](#)
- Narloch, Piotr, Ahmad Hassanat, Ahmad S. Tarawneh, Hubert Anysz, Jakub Kotowski, and Khalid Almohammadi. 2019. Predicting Compressive Strength of Cement-Stabilized Rammed Earth Based on SEM Images Using Computer Vision and Deep Learning. *Applied Sciences* 9: 5131. [\[CrossRef\]](#)
- Nevasalmi, Lauri. 2020. Forecasting multinomial stock returns using machine learning methods. *Journal of Finance and Data Science* 6: 86–106. [\[CrossRef\]](#)
- Nti, Isaac Kofi, Adebayo Felix Adekoya, and Benjamin Asubam Weyori. 2020. A systematic review of fundamental and technical analysis of stock market predictions. *Artificial Intelligence Review* 53: 3007–57. [\[CrossRef\]](#)

- Oxford Business Group. 2017. Egypt's Insurance Sector Posts Strong Growth in Tough Economic Context. Available online: <https://oxfordbusinessgroup.com/overview/catching-sector-posts-strong-growth-tough-economic-context> (accessed on 1 November 2021).
- Oxford Business Group. 2020. Increased Competition and New Regulations Transform the Sector. Available online: <https://oxfordbusinessgroup.com/overview/increased-competition-and-new-regulations-transform-sector> (accessed on 1 November 2021).
- Park, Cheol-Ho, and Scott Irwin. 2007. What do we know about the profitability of technical analysis? *Journal of Economic Surveys* 21: 786–826. [CrossRef]
- Patel, Jigar, Sahil Shah, Priyank Thakkar, and Ketan Kotecha. 2015. Predicting stock market index using fusion of machine learning techniques. *Expert Systems with Applications* 42: 2162–72. [CrossRef]
- Paul, Sanjoy Kumar. 2011. Determination of Exponential Smoothing Constant to Minimize Mean Square Error and Mean Absolute Deviation. *Global Journal of Research in Engineering* 11: 20–31.
- Prechter, Robert R., Jr., and Wayne D. Parker. 2007. The financial/economic dichotomy in social behavioral dynamics: The socioeconomic perspective. *The Journal of Behavioral Finance* 8: 84–108. [CrossRef]
- Qian, Bo, and Khaled Rasheed. 2007. Stock market prediction with multiple classifiers. *Applied Intelligence* 26: 25–33. [CrossRef]
- Qiu, Mingyue, and Song Yu. 2016. Predicting the Direction of Stock Market Index Movement Using an Optimized Artificial Neural Network Model. *PLoS ONE* 11: e0155133. [CrossRef]
- Rawashdeh, Adnan, Mouhammd Alkasassbeh, and Muna Al-Hawawreh. 2018. An anomaly-based approach for DDoS attack detection in cloud environment. *International Journal of Computer Applications in Technology* 57: 312–24.
- Salman, Hamzeh E., Mustafa Hammad, Abdelhak-Djamel Seriai, and Ahed Al-Sbou. 2018. Semantic clustering of functional requirements using agglomerative hierarchical clustering. *Information* 9: 222. [CrossRef]
- Samer, A., M. Rawan, and L. Omar. 2018. The Role of Corporate Social Responsibility in Local Community Development: A study of the Jordan Ahli Bank. *International Journal of Academic Research in Business and Social Sciences* 8: 199–214. [CrossRef]
- Santos, B. M. 2011. Selecting the right nutrient rate: Basis for managing fertilization programs. *HortTechnology* 21: 683–85. [CrossRef]
- Shynkevich, Yauheniya, T. Martin McGinnity, Sonya Coleman, Ammar Belatreche, and Yuhua Li. 2017. Forecasting price movements using technical indicators: Investigating the impact of varying input window length. *Neurocomputing* 264: 71–88. [CrossRef]
- Singh, Aishwarya. 2018. Predicting the Stock Market Using Machine Learning and Deep Learning. *Electronic Research Journal of Engineering, Computer and Applied Sciences* 2: 1–10.
- Singh, Aryendra, Priyanshi Gupta, and Narina Thakur. 2021. An empirical research and comprehensive analysis of stock market prediction using machine learning and deep learning techniques. *IOP Conference Series: Materials Science and Engineering* 1022: 012098. [CrossRef]
- Singh, Shashank, Maaz Ahmad, Aditya Bhattacharya, and M. Azhagiri. 2019. Predicting stock market trends using hybrid SVM model and LSTM with sentiment determination using natural language processing. *International Journal of Engineering and Advanced Technology* 9: 2870–75. [CrossRef]
- Tarawneh, Ahmad S., Ahmad B. Hassanat, Ceyhun Celik, Dmitry Chetverikov, MD S. Rahman, and Chaman Verma. 2019a. Deep Face Image Retrieval: A Comparative Study with Dictionary Learning. Paper presented at the 2019 10th International Conference on Information and Communication Systems (ICICS), Irbid, Jordan, June 11–13.
- Tarawneh, Ahmad S., Ahmad B. Hassanat, Dmitry Chetverikov, I. Lendak, and Chaman Verma. 2019b. Invoice Classification Using Deep Features and Machine Learning Techniques. Paper presented at the 2019 IEEE Jordan International Joint Conference on Electrical Engineering and Information Technology (JEEIT), Irbid, Jordan, April 9–11.
- Tarawneh, Ahmad S., Ahmad B. Hassanat, I. Elkhadiri, Dmitry Chetverikov, and Khaled Almohammadi. 2020a. Automatic Gamma Correction Based on Root-Mean-Square-Error Maximization. Paper presented at the 2020 International Conference on Computing and Information Technology (ICCIT-1441), Tabuk, Saudi Arabia, September 9–10.
- Tarawneh, Ahmad S., Ceyhun Celik, Ahmad B. Hassanat, and Dmitry Chetverikov. 2020b. Detailed investigation of deep features with sparse representation and dimensionality reduction in CBIR: A comparative study. *Intelligent Data Analysis* 24: 47–68. [CrossRef]
- Tarawneh, Ahmad S., Dmitry Chetverikov, Chaman Verma, and Ahmad Hassanat. 2018. Stability and reduction of statistical features for image classification and retrieval: Preliminary results. Paper presented at the 2018 9th International Conference on Information and Communication Systems (ICICS), Irbid, Jordan, April 3–5.
- Taylor, Mark P., and Helen Allen. 1992. The use of technical analysis in the foreign exchange market. *Journal of international Money and Finance* 11: 304–14. [CrossRef]
- Tlili, Sihem, Sami Mnasri, and Thierry Val. 2021. A multi-objective Gray Wolf algorithm for routing in IoT Collection Networks with real experiments. Paper presented at the 2021 IEEE 4th National Computing Colleges Conference, NCCC 2021, Taif, Saudi Arabia, March 27–28.
- Turner, Toni. 2007. *A Beginner's Guide to Day Trading Online*, 2nd ed. Avon: Adams Media.
- Valencia, Franco, Alfonso Gómez-Espinosa, and Benjamín Valdés-Aguirre. 2019. Price movement prediction of cryptocurrencies using sentiment analysis and machine learning. *Entropy* 21: 589. [CrossRef] [PubMed]
- Vasiliou, Dimitrios, Nikolaos Eriotis, and Spyros Papatheasiou. 2006. How rewarding is technical analysis? Evidence from Athens Stock Exchange. *Operational Research* 6: 85–102. [CrossRef]

- Wong, Wing-Keung, Meher Manzur, and Boon-Kiat Chew. 2010. How rewarding is technical analysis? Evidence from Singapore stock. *Applied Financial Economics* 13: 543–51. [[CrossRef](#)]
- Zhong, Xiao, and David Enke. 2019. Predicting the daily return direction of the stock market using hybrid machine learning algorithms. *Financial Innovation* 5: 1–20. [[CrossRef](#)]
- Zhuo, Jinwu, Xinmiao Li, and Changrui Yu. 2021. Parameter behavioral finance model of investor groups based on statistical approaches. *Quarterly Review of Economics and Finance* 80: 74–79. [[CrossRef](#)]
- Zulkarnain, Iskandar. 2014. Research on The Simple Moving Average (SMAs) Technical Analysis Effectiveness: A Test of Conformity with the Earning Per Share of Top Gainers at IDX. Paper presented at the ICE-ISM, Palembang, Indonesia, October 17–18.
- Zuraid, AlMaha A., and Mouhammd Alkasassbeh. 2019. Review: Phishing Detection Approaches. Paper presented at the 2019 2nd International Conference on New Trends in Computing Sciences, ICTCS 2019, Amman, Jordan, October 9–11.

## Article

# Factors Affecting the Intention to Use Financial Technology among Vietnamese Youth: Research in the Time of COVID-19 and Beyond

Nguyen Vinh Khuong<sup>1,2</sup>, Nguyen Thi Thanh Phuong<sup>2,3</sup>, Nguyen Thanh Liem<sup>2,4,\*</sup>, Cao Thi Mien Thuy<sup>2,4</sup> and Tran Hung Son<sup>2,5</sup>

<sup>1</sup> Faculty of Accounting and Auditing, University of Economics and Law, Ho Chi Minh City 700000, Vietnam; khuongnv@uel.edu.vn

<sup>2</sup> Vietnam National University, Ho Chi Minh City 700000, Vietnam; phuongntt194021c@st.uel.edu.vn (N.T.T.P.); thuyctm17704@sdh.uel.edu.vn (C.T.M.T.); sonth@uel.edu.vn (T.H.S.)

<sup>3</sup> Faculty of International Economic Relation, University of Economics and Law, Ho Chi Minh City 700000, Vietnam

<sup>4</sup> Faculty of Finance and Banking, University of Economics and Law, Ho Chi Minh City 700000, Vietnam

<sup>5</sup> Institute for Development and Research in Banking Technology, University of Economics and Law, Ho Chi Minh City 700000, Vietnam

\* Correspondence: liemnt@uel.edu.vn

**Abstract:** This study focuses on understanding the factors that affect the intention of using financial technology among young Vietnamese in the context of the COVID-19 pandemic. Fintech studies are abundant in developed countries and mainly focus on consumers' conditions, awareness, habits, and capital. These are expected to differ significantly from the situation in developing countries. We have reviewed factors that can affect the user's intention, including the Perceived Benefit (PB), Perceived Risk (PR), Belief (B), and Social Influence (SI), and rely on the Technology Acceptance Model (TAM) and the Theory of Reasoned Action (TRA) model in this research. The survey sample comprises 161 Z-generation consumers with strong flexibility and knowledge about the use of Fintech. We use the PLS-SEM (partial least squares structural equation modeling) analysis method with the SmartPLS software (SmartPLS GmbH, Oststeinbek, Germany) to evaluate the research model. We find that the Perceived Benefit (PB) has the most significant impact on the intention to use Fintech, followed by Belief (B). However, in general, the factors are not significant, perhaps due to many reasons that are intrinsic in Vietnam. Based on this result, service providers, policymakers, and researchers can calibrate the development and research for the following stages. We offer findings different from the previous research, thus especially extending the literature on young people.

**Keywords:** financial technology; TAM model; TRA model; COVID-19

**Citation:** Khuong, Nguyen Vinh, Nguyen Thi Thanh Phuong, Nguyen Thanh Liem, Cao Thi Mien Thuy, and Tran Hung Son. 2022. Factors Affecting the Intention to Use Financial Technology among Vietnamese Youth: Research in the Time of COVID-19 and Beyond. *Economies* 10: 57. <https://doi.org/10.3390/economies10030057>

Received: 6 December 2021

Accepted: 23 February 2022

Published: 28 February 2022

**Publisher's Note:** MDPI stays neutral with regard to jurisdictional claims in published maps and institutional affiliations.



**Copyright:** © 2022 by the authors. Licensee MDPI, Basel, Switzerland. This article is an open access article distributed under the terms and conditions of the Creative Commons Attribution (CC BY) license (<https://creativecommons.org/licenses/by/4.0/>).

## 1. Introduction

Financial technology (Fintech) is a term that has been present since the 1990s. In recent years, this term has been increasingly popular because of the robust development of Fintech across the globe. Fintech is meant to shape the future of the financial industry (Lee and Teo 2015). The Fintech ecosystem consists of innovation in core services, business infrastructure, and components and creates a valuable additional mechanism through collaboration by redesigning, nesting, re-functioning, and redirecting financial services between important market stakeholders (Estrin et al. 2018). Fintech is expected to provide new added value and services at a lower cost than traditional technology. The Fintech revolution has been set to affect the incumbent financial service activities by increasing their efficiency, customer-centric character, and transparency (Gomber et al. 2018). Loo believes that if they are freely competitive, Fintech can increase consumer benefits and lower the probability of a financial crisis (Van Loo 2018). However, because this is a very

young industry, it is subject to competition from traditional financial services, and the pressure from gaining the users' acceptance is enormous. Moreover, consumers can face some disadvantages in the application of Fintech products, including the risk of financial losses and privacy concerns (Liébana-Cabanillas et al. 2014).

The intention to use Fintech services is affected by customers' perception of risk: financial risks, legal risks, and activity risks have significant influences, while security risk does not impose any significant impact on the intention to use Fintech (Tang et al. 2020). Another study explores the use of smartphone applications to manage the financing of fishers (Carlin et al. 2017). This research shows that men tend to be more able to adopt new technology than women. Finally, using survey data collected from 244 Fintech users, Hyun-Sun Ryu (Ryu 2018) finds that legal risks have the most significant negative impact, while convenience has the most positive influence on the intention to use Fintech.

In Vietnam, there are few Fintech studies, such as the research on the development of Fintech by Dang Thi Ngoc Lan (Dang) and the study on the factors affecting the choice to continue using Fintech Payment Services among university students by Nguyen Dang Tue (Nguyen 2020).

This study seeks to extend extant studies on several fronts. First, the study analyzes both aspects of benefits and risks in order to offer a more holistic view. Second, the study was conducted in Vietnam, which shows excellent potential for Fintech's development. Vietnam is in a booming period, with nearly 55% of the total population using smartphones and 52% using the Internet. This makes Vietnam the land of promise for Fintech. In fact, there has been a marked increase in the number of Fintech companies, from about 40 companies at the end of 2016 to nearly 150 companies by the end of 2019. The recent COVID-19 pandemic has further encouraged the development of electronic payment. However, the development of Fintech in Vietnam also carries many security threats as Fintech's legal corridor is still in its early stages in this country (Lien et al. 2020). Therefore, exploring the factors affecting awareness and user intentions is absolutely necessary. This study will examine the factors that affect the decision to use financial technology products, especially in the context of the COVID-19 pandemic (Al-Nawayseh 2020). The conditions, awareness, and habits of people as well as other factors regarding Fintech differ between developed and developing markets (Lehmann 2020). As a result, studies in developed countries might not be relevant to Vietnam. The present study will contribute to a broader view of this topic. Third, we use Model TAM and TRA, with results different from the previous research. We also focus on the survey subjects: the Z generation of consumers, who are aged 18–24. They are information consumers and providers who are very good at device skills (Csobanka 2016).

This research contributes to discovering the effects of factors on the access and usage of Fintech users in Vietnam, especially for young people in the COVID-19 period. At the same time, solutions are also provided. Introduced to overcome existing limitations that users of Fintech encounter, companies operating in Vietnam can refer to results presented in this study to improve their services. The study also shows differences in Fintech usage habits and behavior in developing countries when compared to foreign studies.

The article proceeds as follows. Section 2 provides an overview of the Vietnamese research setting. Section 3 provides a discussion of the literature review and formulates hypotheses. The models, estimation methods, and data collection are presented in Section 4. In Section 5, we discuss our findings, followed by conclusions and some recommendations in Section 6.

## 2. Background in Vietnam

### Context

The Vietnamese economy rebounded in the first quarter of 2021 with a GDP (Gross Domestic Product) growth of 4.48%. The increase is still lower than that in 2018 (7.45%), but it has shown signs of recovery compared to 2020. According to the Vietnam Startup Report in Q1 2021 (Vietnam Fintech Report 2020 2020), Fintech showcases a really impressive

performance. In recent years, the number of Fintech companies has increased rapidly in the Vietnamese market and plays a more critical role in the COVID-19 pandemic that hinders traditional financial activities.

Fintech is a potential industry in digital transformation that reduces costs and increases utility for users. In 2020, the Fintech sectors thrived in Payments (accounting for 33% of market share), P2P Lending (15.5%), Blockchain/Crypto (13%), and POS (Point of Sale) and Wealth Management (7%). The users' habit of using traditional financial services is gradually changing as the number of Fintech users is growing, especially with the rise in the number of young users.

Payment is a high potential field, and this is quite understandable because payment activity is essential in everyday life. E-commerce or service providers have seized every opportunity to take part in the trend. Grab bought shares of the startup Moca, a Vietnamese mobile payment application. VinID also acquired Monpay, a payment application. Lazada Vietnam integrated Emonkey into their platforms.

According to *Fintech and Digital Banking 2025 Asia Pacific 2020* (2020), mobile transactions in Vietnam are expected to increase by 400% in the period of 2020–2025, and the number of bank accounts is expected to increase further by about 50% for the top eight leading banks. The rapid increase in accounts and transactions imposes a large pressure on the current banking system. According to this report, the average life expectancy of the core banking system among the top 100 banks in the Asia Pacific region is still at 17.5 years, and this means it would be challenging to respond to the needs of the digital era. Banks in Vietnam are actively converting to modern digital platforms, but it is expected that only about 25% of banks in Vietnam will have been converted by 2025.

According to Vietnam Fintech Report statistics for 2020, 69% of Vietnamese people have savings accounts in banks, 45% of the people have smartphones, and 57% have internet on their phones. These indicators are expected to increase rapidly in the coming years, serving as the necessary conditions for customers to access and effectively use Fintech services quickly.

In addition to the advantages of the demographic characteristics, Fintech companies also have advantages from government support and foreign investment. The State Bank has planned to allow banks and Fintech companies to participate in Sandbox starting in 2022, for a period of 1–2 years. The areas include: payment, credit, P2P lending, customer identification, application programming interface, tech-based solution, and other banking support services. In the future, foreign investment capital pouring into this industry is expected to increase significantly. At the same time, the relationship between commercial banks and Fintech companies will become increasingly tighter to suit the diverse needs of customers.

The competition between the banking system and Fintech companies has been robust, requiring companies to evolve constantly in order to capture customers' needs and improve service quality to retain customers, attract new customers, and expand market share. Therefore, studies on factors that may affect the intention to use Fintech in Vietnam could have practical implications for Fintech firms.

### 3. Theoretical Framework and Hypothesis Development

Since the term "Fintech" appeared, there have been quite a few studies about it around the world. In particular, the adoption of Fintech services has been studied by many scholars, such as the study on how perceived risk factors affect the intention to use Fintech (Tang et al. 2020). This study is expected to close the perceived risk factors of Fintech. Researchers surveyed 302 people, most of them young and middle-aged, with only 55 (18.2%) of the respondents being over 45 years old. It can be said that this research is based on young people who have a good ability to absorb and use technology. The results show that out of the four risks, three—financial risk, legal risk, and operational risk—have a significant influence, while security risk has no significant negative impact on the intention to use Fintech. However, the research has many limitations when focusing only

on perceived risk. In addition, there is a study on the adoption of Fintech services through the generation group of (Carlin et al. 2017). This research exploits the advent of smartphone apps for personal financial management as an exogenous source of transformation. In this study, in addition to the benefits that Fintech brings, people also point out some risks when using financial technology products. The research also shows that a higher proportion of men tend to adopt new technologies and access information, and the impact of their access on the economy is greater than that of women. Research by (Hyun-Sun Ryu 2018) on the framework of benefits and risks of Fintech adoption includes a comparison between adopters and early adopters (Ryu 2018). The research, with the aim of answering the question: “Why are users willing or hesitant to apply Fintech?”, was performed by collecting data from 244 Fintech users. The study investigates the perceived benefits and risks that have a significant impact on Fintech adoption. In addition, the study also examines the effects of perceived benefits and risks when applying Fintech to each type of person. The results show that: Legal risk has the biggest negative impact, while convenience has the most positive influence on the intention to use Fintech.

In Vietnam, there is some research on Fintech, such as the research on the development of Fintech and movements in the field of Finance/Banking by Dr. Dang Thi Ngoc Lan, or research on factors affecting the continuous usage of Fintech payment services—a study on university students in Vietnam by Nguyen Dang Tue. In general, there is still no research on the factors affecting the intention to use Fintech. Therefore, this study may respond to and complement previous studies.

### 3.1. Theory of Reasoned Action (TRA)

Theory of Reasoned Action (TRA) was developed by two psychologists, Martin Fishbein and Icek Ajzen. The theory suggests that the intention to behave impacts someone’s behavior: the intention leads to the occurrence of behavior. Attitudes will include many different types, such as positive, negative, or neutral. A behavior with a positive attitude is supposed to lead to a favorable result (Ajzen and Fishbein 1975).

### 3.2. Technology Acceptance Model (TAM)

Fintech is the result of the creative application of technology in finance and banks to improve services. With the goal of predicting the acceptance of a tool and identifying the modifications that need to be included in the system to make the user accept it, the TAM (Davis 1985) perfectly explains the meaning of acceptance of a new technology.

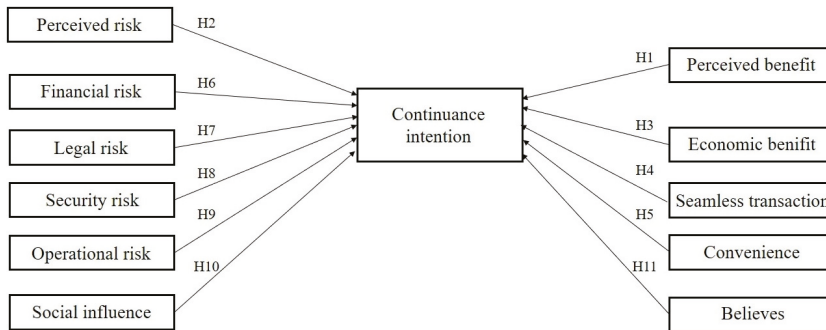
The TAM model shows that acceptance of an information system depends on the usefulness perception and ease of use. According to Davis, usefulness perception and ease of use affect users’ attitudes, thereby affecting the intention to use (Davis 1985). This model has been widely used in many studies on the application of advanced technology to life such as in social networks, digital libraries (Chen et al. 2016), online banking, and mobile banking (Patel and Patel 2018).

### Hypothesis Development

This study proposes a benefit and risk framework by integrating positive and negative factors related to the intention to use Fintech. Previous studies have applied multi-behavioral belief structures to determine the overall benefits and risks. Three key elements of perception have been discussed: economic benefits, seamless transactions, and convenience. Additionally, there are four main factors of risks: financial risks, legal risks, security risks, and operational risks. Therefore, this study assumes that positive and negative factors affect the perceived benefits and risk, significantly affecting the intention to continue using Fintech. The proposed model is summarized in Figure 1.

In this research model, the perceived benefits are defined as “user perception about the benefits of using Fintech”. Perceived benefit is how users believe that using technology will improve efficiency (David 1989). Perceived benefit has a positive impact on the use of products and services (Peter and Tarpey 1975), the use of mobile payment (Liu et al.

2012), the use of Bitcoin (Abramova and Böhme 2016), online shopping (Batara et al. 2018), and the intention to use Internet Banking. Scientists have not agreed on the definition of perceived risk. Perceived risk has a negative impact on the intention to use Fintech (Ryu 2018). Rich defines perceived risk as akin to the uncertainty of whether a person will win or lose the bet amount (Rich and Cox 2014).



**Figure 1.** Research framework. H1-H10 are the hypotheses presented below. Source: Proposal from the author.

Therefore, perceived risk is defined as bad impressions when using Fintech. We suggest the following hypotheses:

**Hypothesis 1:** *Perceived benefit positively impacts intention to continue using Fintech.*

**Hypothesis 2:** *Perceived risk negatively impacts intention to continue using Fintech.*

The economic benefit includes cost reduction and increased profit from Fintech transactions, which are the motivation behind the consumers' intention to continue. According to Mackenzie (Mackenzie 2015), Fintech's mobile transfer or P2P loan may lower costs for users compared to traditional financial service providers. The online shopping research model of Liu (Forsythe et al. 2006) proposed four perceived benefits (convenience, ease, enjoyment, product selection) and three perceived risks (talent risk main, product risk, time risk). According to Zavolokina et al. (2016), seamless transactions help customers to obtain immediate benefits with easy to relate to and customer-friendly financial services platforms.

**Hypothesis 3:** *Economic benefit positively impacts the intention to continue using Fintech.*

**Hypothesis 4:** *Seamless transaction positively impacts the intention to continue using Fintech.*

**Hypothesis 5:** *Convenience positively impacts the intention to continue using Fintech.*

This study shows four risks in the context of Fintech: financial risk, legal risk, security risk, and operational risk. Derbaix defined perceived risk as the "potential net loss of money" (Derbaix 1983). Financial risk is the potential loss due to trading errors and misused bank accounts (Lee 2009). According to Kuisma et al. (2007), many customers are afraid of losing money when making transactions and transferring money over the Internet. The research by Maignan and Lukas indicates that legal risk is a perception of insecurity related to online credit cards (Maignan and Lukas 1997). Consumers perceive the security risk inherently when using Fintech (Schierz et al. 2010). Fraud and hackers' intrusion lead to users' loss and violate user privacy. Consumers said that their information could be easily stolen using online banking services (Littler and Melanathiou 2006). Operational risk



refers to losses due to shortcomings or malfunctions of online shopping sites. In addition, customers fear the possibility of the Internet connection server causing losses (Kuisma et al. 2007). Six perceived risks are financial risk, risk of performance, social risks, physical risks, security risk, and time loss (Jacoby and Kaplan 1972; Kaplan et al. 1974).

**Hypothesis 6:** *Financial risk negatively affects the intention to continue using Fintech.*

**Hypothesis 7:** *Legal risk negatively affects the intention to continue using Fintech.*

**Hypothesis 8:** *Security risk negatively affects the intention to continue using Fintech.*

**Hypothesis 9:** *Operational risk negatively affects the intention to continue using Fintech.*

Social influence is the effect of others within a personal invitation system (Chuang et al. 2016) and the perception of the subjective culture of the reference group (Oliveira et al. 2016), showing that social influence has a significant effect on behavioral intentions to use mobile payment technology in Portugal. Their research asserts that social influence will affect the intention to utilize mobile payment because individuals are easily affected by other people (Oliveira et al. 2016).

**Hypothesis 10:** *Social influence positively impacts the intention to continue using Fintech.*

According to the research by Ali, beliefs strongly affect the intention to use online banking (Omar Ali et al. 2020). Beliefs are a significant component contributing to online banking applications and the integrity of the information technology group that they manage (Chandio et al. 2013).

According to Liébana-Cabanillas et al. (2018) and Oliveira et al. (2016), the critical factor in information technology deployment is the innovation of individuals. Liébana-Cabanillas found a positive and significant relationship between the renewal of the individual and the intention to apply the user's new technology (Liébana-Cabanillas et al. 2018). The innovation of individuals is defined as an individual's readiness to accept new things and use new information technology beyond traditional methods (Agarwal et al. 1998). The innovation of individuals helps reduce their anxiety, producing a positive impact on the acceptance of technology. In contrast to early accepting consumers, late adopters are supposed to accept products in the mature stage and the decline in the life cycle of the product. Rogers and Everett soon accepted innovative technologies even without certainty with its benefits (Rogers 1995). Therefore, this study proposed the following hypothesis.

**Hypothesis 11:** *Beliefs positively impact the intention to continue using Fintech.*

## 4. Research Design

### 4.1. Scale and Structure of the Questionnaire

We divide the questionnaire content into 12 parts, which include: Demographics, Perceived Benefit (PB), Economic Benefit (EB), Seamless Transaction (ST), Convenience (CV), Perceived Risk (PR), Financial Risk (FR), Legal Risk (LR), Security Risk (SR), Operational Risk (OR), Social Influence (SI), Beliefs (B), and Continuance Intention (CI). The above concepts were selected from related studies. In particular, Perceived Risk is from Benlian and Hess (2011), Kim et al. (2008); the Economic Benefit concept and Financial Risk are from Featherman and Pavlou (2003), Lee (2009); Chishti's Seamless Transaction concept is from Chishti (2016); the Convenience concept is from Okazaki and Mendez (2013); the concept of Operational Risk is from Barakat and Hussainey (2013); the Social Influence concept is from Ajzen (1991), Chatterjee (2008), Venkatesh et al. (2003); the Beliefs concept is from Chatterjee (2008), Venkatesh et al. (2003); and the concept of Continuance Intention is from Cheng et al. (2006), Lee (2009).

#### 4.2. Methodology

Quantitative research methods were used in the deductible process (Nguyễn 2012). We used a quantitative survey method to achieve the main research objectives.

A system of concept/scale and observed variables were synthesized and selected from previous studies to match the research objectives, but there was no change in the scale of original concepts. Variables were measured using a Likert scale with five levels: (1) completely disagree; (2) disagree; (3) neutral; (4) agree; (5) completely agree. We used an SPSS 20.0 (International Business Machines Corporation, New York, NY, USA) and Smart PLS software (GmbH, Oststeinbek, Germany) to conduct reliability, correlation, factor, regression, and hypothetical testing.

The PLS\_SEM model (Structural Equation Modeling) is one of the complex techniques used to analyze complex relationships in the causal model. This is a widely used model in research areas, especially in customer satisfaction model research. The SEM model coordinates the techniques for multivariate regression, factor analysis, and mutual relationship between elements in the diagram to check the complex relationship in the model.

This study adopted two models: the measurement model and the structural model. Measurement models (also called factor models) deal with potential variables through indicators such as the reliability of observation variables, determined via Cronbach's Alpha. The structural model is a model that identifies links between potential variables. These relationships can describe the theoretical forecasts that researchers are interested in. The model used an estimated method, with the multiple regression of the observed variables.

In addition, to ensure the highest robustness and accuracy for the model, we estimated the model with the Bootstrap method. Bootstrap is a quantitative research method performed by sampling. The study sample was divided into two sub-samples: one sample was used to estimate the parameters and the other was used to reevaluate the estimated results. The estimated results, after implementing the bootstrap with the number of N times of repetition, was subsequently averaged. If this value was close to the overall estimate, the model estimates could then be trusted.

#### 4.3. Samples and Ways of Collecting Samples

##### 4.3.1. Overall Research

We collected data to satisfy the purpose of the research scope (Nguyễn 2012). The research sample comprised people living, studying, and working in Ho Chi Minh City.

##### 4.3.2. Sampling Method

Research focusing on young people show that they are more compatible with technology products and prefer to use services than previous generations (Vietnam Fintech Report 2020 2020). Therefore, this study focused on this group of subjects. Data were collected by random sampling. The majority of the survey subjects were young people aged 18–24, who were using or had never used Fintech in payment. Due to the limited space and time, the survey was conducted through the sending of forms via email, and the main targets were the students in school and their friends. This resulted in 223 votes, which satisfied the minimum number of observations. The representativeness of the sample was evenly distributed and was shown by the diversity in the responses of the respondents.

Among the 223 answers, there were 161 valid responses. When using PLS\_SEM, the sample size needs to be 10 times the number of paths in the structure model (Hair et al. 2016). There were 11 paths, so the minimum number of observations was 110. In addition, the PLS SEM method is a suitable model with a small sample size, at least 80, so the sample size for the study was considered appropriate. The responses of the respondents have a high diversity. The observations were evenly distributed, thus ensuring the representativeness of the sample. All valid observations were processed using an SPSS 23.0 software and a SmartPLS 3.2.8 software to conduct a reliability analysis, factor analysis, regression analysis, and the testing of hypotheses.

## 5. Results and Discussion

### 5.1. Descriptive Statistics

#### 5.1.1. Demographics

The research was officially conducted from 11 November 2020 to 31 January 2021. The survey questionnaire used in the formal study employed closed questions, measuring the road by scale, namely the 5-level Likert scale.

The surveyed objects included young people, mainly students and workers living in Vietnam. More specifically, the number of people who were using Fintech was 161 (accounting for 72.85%), while 56 people never used Fintech (accounting for 25.34%), and 4 people had used Fintech but were currently not using it (accounting for 1.81%). Thus, the sample size used in the research was 161. Information about the research sample is introduced in Table 1.

Table 1 presents a descriptive statistical result for demographic variables. The study model has many young people (aged 18–24) participating in the most extensive survey, and who account for 98.1%. This result is due to the fact that most of the survey questionnaires were sent to students and young people who quickly change their behavior and awareness of new technology. At the same time, most surveyed subjects were in Ho Chi Minh City (accounting for 92.5%).

**Table 1.** Statistical results describing demographic variables.

	Living Area		
	Quantity	Percentage	
Ho Chi Minh City	149	92.5%	
Others	12	7.5%	
Total	161	100%	
	Age		
	18–24	158	98.1%
	25–34	2	1.2%
	35–39	0	0.0%
	Over 39	1	0.6%
	Total	161	100%

#### 5.1.2. Check Measurement

Table 2 presents the results of the internal stability assessment of each factor, showing that almost all observed variables have an acceptable reliability. The Cronbach's Alpha coefficient of each factor containing observed variables has a high level (>0.7). However, the variables observed—B6, FR2, LR1, and PR3—had the reliability coefficient of 0.457, 0.239, 0.276, and 0.110, respectively, lower than the threshold of 0.5. Therefore, in this study, the B6, FR2, LR1, and PR3 variables were considered from the model.

#### Check the First Measurement Model

The results of the AVE (Average Variance Extracted) show values after checking the measurement model for the first time. The results show that all factors have an AVE > 0.5, including factors with a high AVE index such as CV (0.786), SI (0.795), and SR (0.743). Some factors have lower AVE indexes, such as B (0.609), FR (0.547), LR (0.623), and PR (0.551). These are factors containing variables considered in the type of model in Section 1, and the load factor values and the trust factor of the observation variables are not standard. Therefore, the above variables are removed from the model to perform the second measurement model test.

## Check the Second Measurement Model

The AVE results shown are for the B6, LR1, FR2, and PR3 variables. The results show that the AVE values are larger than 0.5. The factor groups have a better AVE index. Except for the B factors, all the remaining factors are greater than 0.7.

## Conclusion

Results of the measurement model inspection, internal stability tests, and the convergence values of factors in the measurement model are presented in Table 2 below.

**Table 2.** Results of the measurement model inspection.

Latent Variable	Observed Variables	Convergent Validity			Internal Stability		Discriminant Validity
		Factor Loading	Outer Loadings	AVE	Composite Reliability	Cronbach's Alpha	
		>0.7	>0.5	>0.5	0.6–0.95	0.6–0.95	
B	B1	0.836	0.699	0.656	0.919	0.896	Yes
	B2	0.858	0.735				
	B3	0.838	0.702				
	B4	0.789	0.623				
	B5	0.802	0.643				
	B6	0.802	0.643				
	B7	0.731	0.534				
CI	CI1	0.84	0.705	0.714	0.909	0.866	Yes
	CI2	0.871	0.758				
	CI3	0.839	0.703				
	CI4	0.829	0.688				
CV	CV1	0.902	0.814	0.786	0.917	0.864	Yes
	CV2	0.856	0.733				
	CV3	0.900	0.810				
EB	EB1	0.850	0.723	0.715	0.883	0.803	Yes
	EB2	0.826	0.682				
	EB3	0.860	0.740				
FR	FR1	0.930	0.865	0.780	0.876	0.727	Yes
	FR3	0.833	0.694				
LR	LR2	0.889	0.790	0.765	0.907	0.854	Yes
	LR3	0.793	0.629				
	LR4	0.935	0.875				
OR	OR1	0.768	0.590	0.701	0.875	0.793	Yes
	OR2	0.824	0.679				
	OR3	0.913	0.834				
PB	PB1	0.825	0.681	0.696	0.901	0.854	Yes
	PB2	0.858	0.736				
	PB3	0.860	0.740				
	PB4	0.791	0.626				
PR	PR1	0.954	0.911	0.782	0.877	0.747	Yes
	PR2	0.808	0.653				
SI	SI1	0.869	0.775	0.795	0.921	0.871	Yes
	SI2	0.918	0.843				
	SI3	0.887	0.788				
SR	SR1	0.903	0.815	0.742	0.895	0.842	Yes
	SR2	0.716	0.513				
	SR3	0.948	0.899				
ST	ST1	0.870	0.756	0.712	0.881	0.797	Yes
	ST2	0.813	0.661				
	ST3	0.847	0.717				

## Discriminant Validity

The results of the HTMT (Heterotrait-monotrait Ratio of Correlations) index for the model are presented in Table 3.

**Table 3.** Results of HTMT indicators for the second measurement model.

	B	CI	CV	EB	FR	LR	OR	PR	PR	SI	SR	ST
B												
CI	0.534											
CV	0.519	0.684										
EB	0.359	0.512	0.544									
FR	0.245	0.090	0.209	0.090								
LR	0.161	0.142	0.079	0.074	0.584							
OR	0.088	0.166	0.209	0.101	0.403	0.456						
PB	0.430	0.777	0.766	0.549	0.175	0.164	0.178					
PR	0.200	0.084	0.131	0.116	0.700	0.406	0.377	0.135				
SI	0.656	0.486	0.379	0.405	0.125	0.118	0.116	0.363	0.064			
SR	0.169	0.071	0.057	0.100	0.297	0.382	0.631	0.094	0.520	0.067		
ST	0.507	0.564	0.715	0.586	0.270	0.238	0.069	0.691	0.285	0.346	0.056	

Table 3 shows that all variables have an HTMT index of less than 0.9. We also checked the index on the diagonal of the Fornell–Larcker, which is greater than that of other factors. All observed variables have a factor higher than the factor it measured other factors with. Thus, based on the three criteria for measuring the distinction value of the research factors, all the factors in the model achieved differential values.

Table 2 has synthesized specific measurement model inspection results. After we used the three evaluation criteria of the scale: (1) Internal Stability, (2) Convergent Validity, and (3) Discriminant Validity, we found that most research factors were accepted (except the B6, LR1, FR2, and PR3 variables). The research model had no changes compared to the original and was used for analyzing the structural model in the next step.

## 5.1.3. Structural Model

## Evaluate Collinearity Phenomenon

The collinearity test results are shown in Table 4. Because the structural model of the theoretical model only has one dependent variable, which is CI, the VIF coefficient was calculated for the model consisting of the independent variables B, CV, EB, FR, LR, OR, PB, SI, SR, ST, with dependent variables as the CI. Table 4 shows that all independent variables have a VIF coefficient smaller than 5, which means that multi-plus does not exist in the model.

**Table 4.** Collinearity Statistics (VIF).

	Constructs	CI
B.	Beliefs	1.927
CI	Continuance intention	
CV	Convenience	2.341
EB	Economic benefit	1.514
FR	Financial risk	1.621
LR	Legal risk	1.385
OR	Operational risk	1.571
PB	Perceived benefit	1.996
PR	Perceived risk	1.587
SI	Social influence	1.661
SR	Security risk	1.583
ST	Seamless transaction	1.860

Source: Author synthesized the information from research data.

#### Assess the Suitability of Relationships

Table 5 presents the results for the  $p$ -value, T Statistic, and Standard Deviation of each factor affecting the dependent variable.

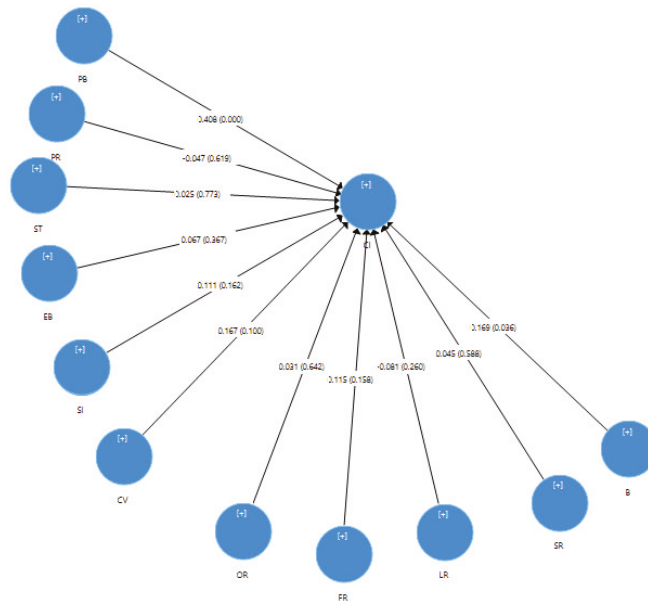
**Table 5.** Results for  $p$ -values, T Statistics, and Standard Deviation of each factor.

	Original Sample (O)	Sample Mean (M)	Standard Deviation (STDEV)	T Statistic ( O/STDEV )	$p$ Value
B → CI	0.169	0.176	0.075	2.242	0.025
CV → CI	0.167	0.149	0.100	1.669	0.096
EB → CI	0.067	0.067	0.074	0.901	0.368
FR → CI	0.115	0.070	0.077	1.493	0.136
LR → CI	−0.081	−0.072	0.071	1.150	0.251
OR → CI	0.031	0.042	0.066	0.466	0.641
PB → CI	0.408	0.403	0.080	5.120	0.000
PR → CI	−0.047	−0.024	0.090	0.521	0.603
SI → CI	0.111	0.112	0.070	1.572	0.117
SR → CI	0.045	0.042	0.079	0.562	0.574
ST → CI	0.025	0.034	0.083	0.300	0.764

Source: Author synthesized the information from research data.

Considering a  $p$ -value index of 0.01, it can be seen that only two factors are of statistical significance, which are beliefs and perceived benefit. All this demonstrates that other factors generally do not affect the Continuance Intention to use Fintech, as originally expected. The cause of this outcome will be explained more clearly in the results.

Figure 2 below shows the results of the model inspection on the Smart Pls software.



**Figure 2.** Model results. Source: Author synthesized the information from research data.

The model test results show that benefits of feelings from Fintech, beliefs, convenience, and financial risks have a negative impact, decreasing the intention to continue using Fintech (the path factors were respectively 0.408; 0.169; 0.167; 0.115). Furthermore, economic benefits, security risks, and operating risks have little impact on the intention to use Fintech (with a path coefficient of 0.067; 0.045; 0.031). Legal risk variables and perceived risk have an opposite effect (with a path coefficient of  $-0.047$ ;  $-0.081$ ).

## 6. Discussion

Generally, there are only a few studies in developing countries, and in Vietnam in particular, which is what motivated us to conduct this study, focusing on benefits and risks that affect the decision to continue to use Fintech in the future. In addition, along with Fintech's rapid development in the context of the COVID-19 pandemic, it is an important new point to understand what affects the intention to use as well as the awareness of Fintech services.

Firstly, Continuance Intention was greatly influenced by Perceived Benefit, including three types of benefits: Convenience, Economic Benefits, and Seamless Transaction. This model was also applied in Forsythe's study (Forsythe et al. 2006). Convenience is obtained when Fintech changes the user's habit from mainly in-cash to non-touch transactions. In addition, users can utilize smart devices to perform many remote financial services. This promotes the participation of a young user group in the use of Fintech services; this group adapts fast to technology and opts for convenience in daily life. Seamless Transaction also affects the benefits of feeling. Seamless transactions help clients to get immediate benefits, providing easy contact with customer-friendly financial services platforms (Zavolokina et al. 2016). A characteristic of traditional finance is that users cannot trade when trading institutions have offended their sessions, while Fintech allows users to trade quickly at any time. Similarly, economic benefit is also worth considering because the fee is exempted from fixed costs such as those imposed by the trading system, and the personnel is replaced with technology. This more or less affects trading costs on fintech platforms. According to Mackenzie (2015), Fintech mobile transfers or P2P loans can reduce costs for users, comparable to traditional financial service providers. The benefit of the Continuance

Intention suggests that users have gradually become aware of the valuable benefits that Fintech brings. They use it more in everyday life, especially for small transactions.

Secondly, Perceived Risk has a negative impact on Continuance Intention to use Fintech, which means that users hesitate when faced with the risks they may encounter, including Operational Risk, Security Risk, Legal Risk, and Financial Risk. Indeed, the fact that technology platforms often have errors will prevent the intention to continue transactions, generating psychological insecurity if important transactions must be made. This is consistent with the views of many studies, such as those by [Kuisma et al. \(2007\)](#); [Benlian and Hess \(2011\)](#); [Kim et al. \(2008\)](#). Moreover, the psychological fear of leaking personal information, especially finance-related information, is a big concern because there have been many information leaks that have caused significant damage in the financial industry. This result is also consistent with the results of [Schierz et al. \(2010\)](#) and [Littler and Melanthiou \(2006\)](#). The financial risk handling policy of most Fintech companies has not guaranteed users' interests. Risk handling in cases related to financing is quite delayed and often takes a long time, sometimes not resolved, which is also the main reason why Fintech transactions often do not have a high value. In the case of a dispute, although the government has relevant laws, it is also a new field, the code is not really complete, and has not been accessed by many people.

Thirdly, Social influence positively affects users; they use Fintech due to the introduction by other people or from seeing people around them. This will help expand the user network and promote the range of other utilities. Oliveira's research confirms that Social Influence will influence the intention of mobile payment behavior because individuals are easily influenced by others ([Oliveira et al. 2016](#)). An example is in the field of money transfer; if more people use Fintech, they can transfer money to each other in the same system or outside the system. However, if the recipients do not use it, they will have to transfer money in another form, such as cash.

Fourthly, users put much belief in the service providers and Fintech platforms. In doing so, they believe that the security of their personal information and their transactions occur when they do not dare to question. A similar opinion was also concluded by ([Omar Ali et al. 2020](#)) and ([Chandio et al. 2013](#)), who hold the view that trust strongly influences the intention to use online banking and is an important component contributing to online banking and the integrity of the information technology management team. This can explain the company that provides services to improve the security system to meet international certification requirements on their platforms and extensive information on communication channels. In addition, the regulations of the state are not adequate but have been and are being amended gradually to ensure that the benefits of users are also the reason for more trust from users. Notifications of transparent transactions that are clear and sent to them immediately allow users to check for themselves and directly report to the system in case problems arise. Therefore, the factor of confidence positively influences the intention to use Fintech.

In general, the research results presented are mostly without statistical significance. This could be because the Fintech market has only developed in recent years, so the number of people who know and use it is very small compared to the population size. In the era of the COVID-19 pandemic, new consumers have a more precise awareness of the benefits that Fintech brings, but because the study was deployed in the early stages of the epidemic, they are still unable to evaluate all the sets. Despite the benefits, the risks still exist, even in epidemics. The legal corridor is unclear with most units of the release of unexpected applications, which do not help users to understand the rights and risks, leading to a lack of motivation to use the Fintech service. Therefore, further research is needed in this context during and after the COVID-19 pandemic in order to make a more accurate assessment of this issue.



## 7. Conclusions and Implications

### 7.1. Conclusions

This study documented the following significant results: Firstly, the benefits of using Fintech positively affect users, thanks to the economic benefits and the convenience of using Fintech.

The benefits include easy transactions, safety and security levels, autonomy, advantages, and customers' attitudes. This study also strengthened the theory of the TAM model and previous studies. From there, to improve the likelihood of using Fintech services in personal customer payments, credit institutions need to improve the quality of service by continuously innovating, making the service convenient and comfortable for users.

Secondly, the intention to continue using Fintech is positively related to the benefits from Fintech and is negatively affected by the risks it brings. Therefore, Fintech service providers need to focus on the benefits factor that Fintech offers and the negative effects of risks to enhance the perceived benefits and reduce risks during the use of Fintech.

### 7.2. Theoretical Contribution

For the TRA model, Perceived Risk and Legal Risk have a negative effect on the dependent variable, representing the user's anxious attitude towards perceived risks. Likewise, the perception of benefits when using Fintech positively affects their intention to use. This is completely consistent with Ajzen's theoretical framework (Ajzen and Fishbein 1975).

The research has contributed to the background theory mentioned above. According to the TAM model, perceived usefulness and ease of use affect users' attitudes, which in turn influence the intention to use. The perceived benefit factor in the research model of the topic also had a great impact on users' intention to use Fintech, playing the most important role among all factors surveyed.

In addition, some results contributed to the results of previous studies. In the context of emerging markets, users' awareness, behavior, and habits of using Fintech in Vietnam were still low, but there were changes, especially during the COVID-19 pandemic. This shows the impact of factors that affect the intention to use Fintech, with the biggest influence coming from the Perceived Benefit factor. David asserted that perceived benefits positively influence the use of products and services (Peter and Tarpey 1975), similar to the views of Liu with regard to the use of mobile payments (Liu et al. 2012), the use of Bitcoin (Abramova and Böhme 2016), or when shopping online (Batara et al. 2018). Therefore, with similar results, this study has contributed to previous studies, providing more understanding of user groups from developing countries.

The research results also showed the impact of the trust factor on the intention to use Fintech, which is the second biggest influencing factor after Perceived Benefit. The trust factor was also included in the research model, and the results are consistent with our point of view. Ali asserted that trust strongly influences the intention to use online banking (Omar Ali et al. 2020); Chandio's view also stated that trust is an important component contributing to online banking applications (Chandio et al. 2013).

### 7.3. Practice Contribution

After implementing the research analysis process, we found that the companies currently providing financial services need to address some of the issues below to promote the continuous use of their services by their customers:

Fintech service organizations need to invest more in information technology and improve information security for users; they also need to try to make it easy to understand the interface design and increase users' comfort. Secondly, Fintech service providers need communication and promotion through the media, highlighting the benefits and convenience when using Fintech in payment. Thirdly, one of the major interests of customers is the company's settlement policy in case there is a loss of customers' rights. The capacity to handle risks and the complaints of organizations and enterprises that provide financial

services is still weak, but not deeply, leading to delays in risk processing and damage to users. Therefore, companies need to focus on this particular team, improve the relevant professional capacity, and commit to compensation and transparent policies for users to trust the products derived from technology. Fourthly, financial technology products show the capacity to be superior to traditional financial services in terms of convenience. This is also why users are gradually using these products more in everyday life. Therefore, businesses and service companies need to invest in improved research to enhance convenience and integration with many new features close to users, thereby creating the riddle effect and expanding the user network. Fifthly, state regulations can affect the intention to use financial technology products. Regulations are still loose and do not solve core problems. With the goal of developing non-cash payments, the improvement of the legal system will inevitably help financial technology services in particular, and the Vietnamese financial landscape in general, facilitating the transfer of users and catching up with the trends of the world.

Although the study was completed and achieved significant results, there are some limitations. Firstly, because the study uses a small number of observations, generalizability may suffer. Secondly, this study focuses on young people in Vietnam, so it is not representative of all behaviors across age groups. Research subjects were mainly aged 18–24, limiting the types of subjects and not considering more age categories. In the future, we expect to expand the scope of the research, especially in the age group from 25 to 39, to have a more comprehensive assessment to supplement the existing results, thereby improving the applicability of the research topic. Finally, though the conclusions are meant to encourage users to use Fintech, due to the restriction of sampling, the general ability of the study is limited.

**Author Contributions:** All authors contributed to conceptualization, formal analysis, investigation, methodology, and writing and editing of the original draft. All authors have read and agreed to the published version of the manuscript.

**Funding:** This research is funded by the University of Economics and Law, Vietnam National University, Ho Chi Minh City, Vietnam.

**Institutional Review Board Statement:** Not applicable.

**Informed Consent Statement:** Informed consent was obtained for primary data via survey.

**Data Availability Statement:** The data will be made available on request from the corresponding author.

**Conflicts of Interest:** The authors declare no conflict of interest.

## References

- Abramova, Svetlana, and Rainer Böhme. 2016. Perceived Benefit and Risk as Multidimensional Determinants of Bitcoin Use: A Quantitative Exploratory Study. Paper presented at Thirty Seventh International Conference on Information Systems, Dublin, Ireland, December 11–14.
- Agarwal, Ritu, Manju Ahuja, Pamela E. Carter, and Mitch Gans. 1998. Early and late adopters of IT innovations: Extensions to innovation diffusion theory. *Proceedings of the DIGIT Conference* 1: 18.
- Ajzen, Icek. 1991. The theory of planned behavior. *Organizational Behavior and Human Decision Processes* 50: 179–211. [\[CrossRef\]](#)
- Ajzen, Icek, and Martin Fishbein. 1975. A Bayesian analysis of attribution processes. *Psychological Bulletin* 82: 261. [\[CrossRef\]](#)
- Al-Nawayseh, Mohammad K. 2020. Fintech in COVID-19 and beyond: What factors are affecting customers' choice of FinTech applications? *Journal of Open Innovation: Technology, Market, and Complexity* 6: 153. [\[CrossRef\]](#)
- Barakat, Ahmed, and Khaled Hussainey. 2013. Bank governance, regulation, supervision, and risk reporting: Evidence from operational risk disclosures in European banks. *International Review of Financial Analysis* 30: 254–73. [\[CrossRef\]](#)
- Batara, Jame Bryan L., Joanna Paula R. Mariblanca, Karlo Mar D. Kinaadman, and Jandall Airon B. Go. 2018. The Effect of Consumer Innovativeness, Perceived Benefits, Perceived Risk, and Brand Image in the Decision to Buy Online. *Recoletos Multidisciplinary Research Journal* 6: 55–64. [\[CrossRef\]](#)
- Benlian, Alexander, and Thomas Hess. 2011. Opportunities and risks of software-as-a-service: Findings from a survey of IT executives. *Decision Support Systems* 52: 232–46. [\[CrossRef\]](#)

- Carlin, Bruce, Arna Olafsson, and Michaela Pagel. 2017. *Fintech Adoption across Generations: Financial Fitness in the Information Age*. Cambridge: National Bureau of Economic Research.
- Chandio, Fida Hussain, Muhammad Sharif Abbasi, Hyder Ali Nizamani, and Qurat Ul Ain Nizamani. 2013. Online banking information systems acceptance: A structural equation modelling analysis. *International Journal of Business Information Systems* 12: 177–93. [CrossRef]
- Chatterjee, Sutirtha. 2008. *Unethical Behavior Using Information Technology*. Washington, DC: Washington State University.
- Chen, Jung-Fang, Jui-Fang Chang, Cheng-Wan Kao, and Yueh-Min Huang. 2016. *Integrating ISSM into TAM to Enhance Digital Library Services: A Case Study of the Taiwan Digital Meta-Library*. Taiwan: The Electronic Library.
- Cheng, T. C. Edwin, David Y. C. Lam, and Andy C. L. Yeung. 2006. Adoption of internet banking: An empirical study in Hong Kong. *Decision Support Systems* 42: 1558–72. [CrossRef]
- Chishty, Susanne. 2016. How peer to peer lending and crowdfunding drive the fintech revolution in the UK. In *Banking beyond Banks and Money*. Berlin/Heidelberg: Springer, pp. 55–68.
- Chuang, Yating, Xiaofei Xie, and Chang Liu. 2016. Interdependent orientations increase pro-environmental preferences when facing self-interest conflicts: The mediating role of self-control. *Journal of Environmental Psychology* 46: 96–105. [CrossRef]
- Csobanka, Zsuzsa Emese. 2016. The Z generation. *Acta Technologica Dubnicae* 6: 63–76. [CrossRef]
- Dang, Thi Ngoc Lan. *Quá Trình Phát Triển Của Fintech Và Những Chuyển Động Trong Lĩnh Vực Tài Chính-Ngân Hàng*. Available online: <http://sob.uoh.edu.vn/wp-content/uploads/2018/11/19.-DANG-THI-NGOC-LAN.pdf> (accessed on 12 October 2021).
- David, Paul A. 1989. *Computer and Dynamo: The Modern Productivity Paradox in a Not-Too Distant Mirror*. Coventry: University of Warwick.
- Davis, Fred D. 1985. *A Technology Acceptance Model for Empirically Testing New End-User Information Systems: Theory and Results*. Cambridge: Massachusetts Institute of Technology.
- Derbaix, Christian. 1983. Perceived risk and risk relievers: An empirical investigation. *Journal of Economic Psychology* 3: 19–38. [CrossRef]
- Estrin, Saul, Daniel Gozman, and Susanna Khavul. 2018. The evolution and adoption of equity crowdfunding: Entrepreneur and investor entry into a new market. *Small Business Economics* 51: 425–39. [CrossRef]
- Featherman, Mauricio S, and Paul A. Pavlou. 2003. Predicting e-services adoption: A perceived risk facets perspective. *International Journal of Human-Computer Studies* 59: 451–74. [CrossRef]
- Fintech and Digital Banking 2025 Asia Pacific*. 2020. Boston: IDC Financial Insight and Backbase.
- Forsythe, Sandra, Chuanlan Liu, David Shannon, and Liu Chun Gardner. 2006. Development of a scale to measure the perceived benefits and risks of online shopping. *Journal of Interactive Marketing* 20: 55–75. [CrossRef]
- Gomber, Peter, Robert J. Kauffman, Chris Parker, and Bruce W. Weber. 2018. On the fintech revolution: Interpreting the forces of innovation, disruption, and transformation in financial services. *Journal of Management Information Systems* 35: 220–65. [CrossRef]
- Hair, Joseph F, Marko Sarstedt, Christian M Ringle, Kai O. Thiele, and Siegfried P. Gudergan. 2016. Estimation issues with PLS and CBSEM: Where the bias lies! *Journal of Business Research* 69: 3998–4010.
- Jacoby, Jacob, and Leon B. Kaplan. 1972. *The Components of Perceived Risk*. Chicago: ACR Special Volumes.
- Kaplan, Leon B., George J. Szybillo, and Jacob Jacoby. 1974. Components of perceived risk in product purchase: A cross-validation. *Journal of Applied Psychology* 59: 287. [CrossRef]
- Kim, Dan J., Donald L. Ferrin, and H. Raghav Rao. 2008. A trust-based consumer decision-making model in electronic commerce: The role of trust, perceived risk, and their antecedents. *Decision Support Systems* 44: 544–64. [CrossRef]
- Kuisma, Tuire, Tommi Laukkanen, and Mika Hiltunen. 2007. Mapping the reasons for resistance to Internet banking: A means-end approach. *International Journal of Information Management* 27: 75–85. [CrossRef]
- Lee, David Kuo Chuen, and Ernie G. S. Teo. 2015. Emergence of FinTech and the LASIC Principles. *Journal of Financial Perspectives* 3: 24–36. [CrossRef]
- Lee, Ming-Chi. 2009. Factors influencing the adoption of internet banking: An integration of TAM and TPB with perceived risk and perceived benefit. *Electronic Commerce Research and Applications* 8: 130–41. [CrossRef]
- Lehmann, Matthias. 2020. Global Rules for a Global Market Place?—Regulation and Supervision of Fintech Providers. *BU Int'l LJ* 38: 118. [CrossRef]
- Liébana-Cabanillas, Francisco, Francisco Muñoz-Leiva, and Juan Sánchez-Fernández. 2018. A global approach to the analysis of user behavior in mobile payment systems in the new electronic environment. *Service Business* 12: 25–64. [CrossRef]
- Liébana-Cabanillas, Francisco, Juan Sánchez-Fernández, and Francisco Muñoz-Leiva. 2014. Antecedents of the adoption of the new mobile payment systems: The moderating effect of age. *Computers in Human Behavior* 35: 464–78. [CrossRef]
- Lien, Nguyen Thi Kim, Thu-Trang Thi Doan, and Toan Ngoc Bui. 2020. Fintech and banking: Evidence from Vietnam. *The Journal of Asian Finance, Economics, and Business* 7: 419–26. [CrossRef]
- Littler, Dale, and Demetris Melanthiou. 2006. Consumer perceptions of risk and uncertainty and the implications for behaviour towards innovative retail services: The case of internet banking. *Journal of Retailing and Consumer Services* 13: 431–43. [CrossRef]
- Liu, SiLu, Yue Zhuo, Dilip Soman, and Min Zhao. 2012. *The Consumer Implications of the Use of Electronic and Mobile Payment Systems*. Toronto: Rotman School of Management, University of Toronto.
- Mackenzie, Annette. 2015. The fintech revolution. *London Business School Review* 26: 50–53. [CrossRef]

- Maignan, Isabelle, and Bryan A. Lukas. 1997. The nature and social uses of the Internet: A qualitative investigation. *Journal of Consumer Affairs* 31: 346–71. [\[CrossRef\]](#)
- Nguyen, Dang Tue. 2020. *Nhân Tố Tác Động Tới Việc Tiếp Tục Sử Dụng Dịch Vụ Thanh Toán Bằng Fintech-Nghiên Cứu Đối Với Sinh Viên Các Trường Đại Học ở Việt Nam*. Hanoi: Tạp chí Quản lý và Kinh tế quốc tế.
- Nguyễn, Đình Thọ. 2012. *Phương Pháp Nghiên Cứu Khoa Học Trong Kinh Doanh*. Hanoi: Lao động xã hội.
- Okazaki, Shintaro, and Felipe Mendez. 2013. Exploring convenience in mobile commerce: Moderating effects of gender. *Computers in Human Behavior* 29: 1234–42. [\[CrossRef\]](#)
- Oliveira, Tiago, Manoj Thomas, Goncalo Baptista, and Filipe Campos. 2016. Mobile payment: Understanding the determinants of customer adoption and intention to recommend the technology. *Computers in Human Behavior* 61: 404–14. [\[CrossRef\]](#)
- Omar Ali, Siti Rapidah, Wan Nur Khadijah Wan Marzuki, Nur Shafini Mohd Said, Suhaily Maizan Abdul Manaf, and Nur Dalila Adenan. 2020. Perceived ease of use and trust towards intention to use online banking in Malaysia. *Jurnal Intelek* 15: 107–14. [\[CrossRef\]](#)
- Patel, Kiran J., and Hiren J. Patel. 2018. Adoption of internet banking services in Gujarat: An extension of TAM with perceived security and social influence. *International Journal of Bank Marketing* 36: 147–69. [\[CrossRef\]](#)
- Peter, J. Paul, and Lawrence X. Tarpey Sr. 1975. A comparative analysis of three consumer decision strategies. *Journal of Consumer Research* 2: 29–37. [\[CrossRef\]](#)
- Rich, Stuart U., and Donald F. Cox. 2014. Perceived risk and consumer decision making: The case of telephone shopping. *Journal of Marketing Research* 1: 32–39.
- Rogers, Everett M. 1995. Diffusion of Innovations: Modifications of a model for telecommunications. In *Die Diffusion von Innovationen in der Telekommunikation*. Berlin/Heidelberg: Springer, pp. 25–38.
- Ryu, Hyun-Sun. 2018. Understanding benefit and risk framework of fintech adoption: Comparison of early adopters and late adopters. Paper presented at the 51st Hawaii International Conference on System Sciences, Hilton Waikoloa Village, HI, USA, January 3–6.
- Schierz, Paul Gerhardt, Oliver Schilke, and Bernd W. Wirtz. 2010. Understanding consumer acceptance of mobile payment services: An empirical analysis. *Electronic Commerce Research and Applications* 9: 209–16. [\[CrossRef\]](#)
- Tang, Kin Leong, Chee Keong Ooi, and Jia Bao Chong. 2020. Perceived Risk Factors Affect Intention To Use FinTech. *Journal of Accounting and Finance in Emerging Economies* 6: 453–63. [\[CrossRef\]](#)
- Van Loo, Rory. 2018. Making innovation more competitive: The case of fintech. *UCLA Law Review* 65: 232.
- Venkatesh, Viswanath, Michael G. Morris, Gordon B. Davis, and Fred D. Davis. 2003. User acceptance of information technology: Toward a unified view. *MIS Quarterly* 27: 425–78. [\[CrossRef\]](#)
- Vietnam Fintech Report 2020*. 2020. Singapore: Fintech News Network.
- Zavolokina, Liudmila, Mateusz Dolata, and Gerhard Schwabe. 2016. FinTech transformation: How IT-enabled innovations shape the financial sector. In *FinanceCom 2016*. Berlin/Heidelberg: Springer.



## Article

# The Potential Impact of COVID-19 on the Chinese GDP, Trade, and Economy

Zohal Habibi <sup>1</sup>, Hamed Habibi <sup>1,\*</sup> and Mohammad Aqa Mohammadi <sup>2,\*</sup>

<sup>1</sup> Department of International Economics, School of Economic, Hefei University of Technology, Hefei 230009, China; zohalhabibi20@gmail.com

<sup>2</sup> College of Horticulture, Fujian Agriculture and Forestry University, Fuzhou 350002, China

\* Correspondence: hamed.habibi1@gmail.com (H.H.); 1161906001@m.fafu.edu.cn (M.A.M.); Tel.: +86-139-6672-3052 (H.H.); +86-180-2088-3292 (M.A.M.)

**Abstract:** COVID-19, a novel Coronavirus SARS-CoV-2, has wreaked havoc on global financial markets, economies, and societies. For example, this study looks at the impact of COVID-19 on the Chinese economy and its policy responses (fiscal, monetary, and institutional). This study also examines future issues. This study is timely and essential for policymakers and investors worldwide because of China's size, contribution to global growth, and growing influence. The research shows that the presence of COVID-19 in China has global implications. Because of the virus threat, foreigners avoid mixing with the Chinese. Global tourists have cancelled their plans to visit China, and Chinese tourists cannot visit foreign countries. The rapid spread of the COVID-19 in China has halted normal life. The intensification of the COVID-19 may have long-term effects on China's economy.

**Keywords:** COVID-19; trade; GDP; economy

**Citation:** Habibi, Zohal, Hamed Habibi, and Mohammad Aqa Mohammadi. 2022. The Potential Impact of COVID-19 on the Chinese GDP, Trade, and Economy. *Economies* 10: 73. <https://doi.org/10.3390/economies10040073>

Academic Editor: Ralf Fendel

Received: 26 December 2021

Accepted: 27 January 2022

Published: 24 March 2022

**Publisher's Note:** MDPI stays neutral with regard to jurisdictional claims in published maps and institutional affiliations.



**Copyright:** © 2022 by the authors. Licensee MDPI, Basel, Switzerland. This article is an open access article distributed under the terms and conditions of the Creative Commons Attribution (CC BY) license (<https://creativecommons.org/licenses/by/4.0/>).

## 1. Introduction

The outbreak of the COVID-19 pandemic affected the global economy. COVID is an enormous group of infections that can cause several illnesses, such as minor cough, extreme respiratory severe condition (SARS), and Middle East respiratory disorder (MERS). In China, a worldwide spread of the virus COVID-19 has broken out, as it is the developed form of Coronavirus (Clinics 2020) and numerous other COVID strains contracted from bat populaces. The symptoms of this virus appear after 2 to 14 days in patients, and most patients face breathing problems, fever, and sickness. The seriousness of the indications of the new COVID-19 infection shifts from individual to individual very quickly. This infection is perceived inside and out, yet most seriously sick patients are older or are experiencing other genuine and persistent illnesses. This virus is more deadly for patients with respiratory illnesses, such as influenza or other illnesses (Clinics 2020).

The first case was registered in December 2019. It is considered a deadly virus that infected more than 52 million people globally. The death rate was also high, as 1.2 million people died from this fatal virus by November 2020 (Kuckertz et al. 2020). So, it has a broad negative impact on the lives and health of people. Regardless of the health sector, COVID-19 negatively impacted economic activities. The COVID-19 pandemic badly affected almost all sectors of the economy by reducing their performance and activities. Hoteling, transportation, manufacturing, tourism, and trade industries experienced a remarkable decline in their revenues.

Some statistics show that COVID-19 is negatively impactful for global economies, such as that the world's GDP declined 2% below its benchmark, and developing countries declined their GDP by about 2.5%. Industrial and developed countries reduced their GDP by about 1.8% (Islam et al. 2020). This virus spread worldwide very quickly, and most countries closed their borders to the entire world. This caused a considerable reduction in international trade, immigration, and tourism. The World Health Organization (WHO)

suggested these isolation policies, so developing countries also employed these policies. The services sector suffered greatly from this pandemic because all countries restricted social interaction. Therefore, many labour forces became unemployed, especially those engaged in the tourism and transportation sector. The manufacturing industry was also shut down, and it caused unemployment. The demand and supply mechanisms were negatively disturbed by this situation (Kuckertz et al. 2020).

The COVID-19 virus commonly spreads through sniffles, touch, or talks that create tiny drops in the environment. These beads are too hefty to ever stay in the air and drop on the floor or onto different surfaces. Suppose that people are inside and one meter away from a COVID-19 patient. In that case, they might be tainted by breathing in the infection or touching a polluted surface before washing hands and afterward touching their eyes, nose, or mouth (WHO 2020). Currently, no antibody or any other antiviral medication is available that can forestall or treat the COVID-19 infection. However, tainted individuals should get treatment and maintain social distance, while severe patients should be hospitalized. Most patients recover in the wake of accepting a steady treatment. Immunizations and particular medication treatments are being investigated and tried through clinical preliminaries. The World Health Organization (WHO) is, until further notice, planning antibody and medication advancement to forestall and treat COVID-19 (WHO 2020). As per the most recent forecast model of Harvard University, the pandemic may have a more genuine episode, and there may, in any case, be a repeat before 2025. Considering the information demonstrated, the analysts proposed to foresee that without antibodies or other powerful medicines, the pandemic may even repeat before 2025. Accordingly, the investigation highlighted a critical chance: this pandemic, which has given many nations bad dreams, will have the danger of returning what is to come (Yu et al. 2021).

Similarly, given the information displayed, the analysts propose that without antibodies or other successful medicines, COVID-19 may even repeat before 2025, according to a recent statistics review (Qiu 2021). For group invulnerability, it is necessitated that adequate treatment or precautions be tainted. The absence of accessible hosts stops the transmission of the infection, and it occurs after far and wide openness. With an illness as pervasive as COVID-19, specialists accept that more than 66% of the populace would be resistant so that crowd insusceptibility can be made. Therefore, much work is needed to save humanity from COVID-19 (Craven et al. 2020).

The new coronavirus (COVID-19) outbreak has resulted in a public health catastrophe and an economic crisis on a global scale, affecting a wide range of sectors. Having been initially hit by the COVID-19 pandemic, China was also the first country to recover and resume economic activity. COVID-19's impact on SMEs in China was investigated in February 2020, and this report proposes governmental initiatives to mitigate the detrimental consequences of the pandemic on small- and medium-sized enterprises (SMEs) (Lu et al. 2021).

There are many fiscal policies, such as subsidies, increases in spending, loans, and equity purchases. Chinese governments chose to extend long-term loans to the industrial sector. These long-term loans will help the industrial and business sectors continue their business. Moreover, it will ensure the employment of the labour class and the provision of commodities to households. Long-term loans will build business people's confidence, and they will adequately run the business because they have no fear of repaying loans early (Meng et al. 2020). This loan amount will promote economic activity and help other linked industries. However, these loans should provide a low-interest rate compared to the market rate, and governments may advise the banks about the timely and easy provision of credit. So, government loans are senior to other banks loans. The subsidy and transfer payment have many disadvantages, such as it will not precisely promote economic activity. The free-of-cost government assistance may make the people in business passive and will not work to promote economic activities.

### *Objectives of the Study*

The study looks at the impact of COVID-19 on the Economy of China, and this is the study general objective. The study uses the first wave of COVID-19 for empirical estimation. Different indicators measure economic performance, but this study uses GDP growth, industrial sector, and international trade. The study is followed by Liu, 2021 on how the Chinese economy was affected by Covid-19. There are a set of specific objectives by which general-purpose can be achieved.

- To explore the relationship between COVID-19 and GDP growth.
- To explore the relationship between COVID-19 and the industrial sector.
- Impact of COVID-19 on international trade of China.
- To deliver the theoretical context of the COVID-19 pandemic.
- To provide the trend analysis of COVID-19 and the economic growth of China.
- Suggest policy implications so that the negative impacts of COVID-19 can be minimized.

### **2. Review of Previous Studies Related to COVID-19**

Many studies discussed this pandemic; (Dhar 2020) tried to explore the impact of COVID-19 on the economy of China. The study found the effects of COVID-19 on GDP, the balance of trade, and the stock exchange. COVID-19 negatively impacted Chinese exports and imports. Exports declined up to 17.5%, and imports decreased by 4%. The outbreak of COVID-19 also caused the decline of share prices, such as SSECI, which decreased by 36 points. Social distancing and isolation policies also minimized production and other economic activities. So, the GDP of China did achieve its targeted value due to the spread of the COVID-19 pandemic.

Liu and Hu (2020) examined the impact of COVID-19 on the Chinese economy. The study used the neoclassical growth model. The study found that while the COVID outbreak did not affect China's domestic demand, the virus's global spread reduced the Chinese goods market. With time, China's social distancing policies caused a significant decline in production. The global spread of COVID-19 and the WHO-recommended border closures harmed trade balance. The study could not examine the long-term effects of COVID-19 on the Chinese economy. So, as COVID-19 spread globally, the saving rate increased in China, which may be used in economic activities.

The OECD (Yang and Deng 2021) studied the impact of COVID-19 on the global and Chinese economies. The study used the NIGEM macro model and suggested an exogenous fiscal policy to mitigate the study's adverse effects. In the worst-case scenario of COVID-19, more spending, lower taxes, and subsidies were beneficial. According to the study, China's demand fell by 2% to 4%. Commodity prices fell 10% globally, and the global GDP fell 0.5% in 2020. Due to the global spread of COVID-19, China's GDP fell 0.2%, and imports fell 6.0%.

To investigate the impact of COVID-19 on the economy (Wei et al. 2021), the study found that the outbreak of COVID-19 disrupted production, business, and households' standard of living. As the industrial sector is vital to an economy, COVID-19 harms their industry, causing many businesses to close. This situation makes it difficult for businesses to manage credit, staff, and expenses.

Luo et al. (2020) studied the Chinese economy and found several impacts of COVID-19. Globalization has accelerated the spread of COVID-19, which began in China. The study found that China's social distancing and isolation policies slowed the spread of COVID-19 but hampered economic activity. China's declining production and border closures affected global and Chinese economies. The study found a 3% global GDP decline in 2020, with developing countries losing 4% to 7%. The author used graphs to examine China's GDP growth and fluctuations in other economic sectors.

Wang and Su (2020) studied COVID-19's economic effects in China. The author estimated that COVID-19 broke out, and high risks cities shut down in January 2020. The study also investigated how China could spread COVID-19, which had no new cases in



March. The study found that the COVID-19 outbreak reduced consumption. Shutdown policies also harmed other economic sectors, such as industry, transportation, tourism, and education. Moreover, the shutdown and isolation policies reduced investment, resulting in lower GDP growth. Export and import levels fell due to WHO restrictions, the author added.

COVID-19 had a negative impact on all sectors of the economy, but this study (Zhang et al. 2020) focused on the agriculture sector of China. This study also investigates the impact of COVID-19 on macroeconomic indicators. The author used SAM multiplier analysis to discover many results. The study found that China's GDP fell 6.8% in the first quarter of 2020, with the agriculture sector losing RMB 0.26 trillion. This represents a 7% loss in agricultural value-added and a 27% loss in agricultural employment. In 2020, the agricultural sectors target growth rate was 1.1%, but it only reached 0.4%. The author stated that the agricultural sector suffered due to the drop in global demand for Chinese agricultural products.

COVID-19 and China's agricultural exports were examined by Lin and Zhang (2020). The COVID-19 outbreak disrupted agricultural supplies from China to the world. The study focused on the agriculturally rich Fujian Province in China. This study used regression analysis and found some critical results. With the spread of COVID-19 came a decline in agricultural exports, which worsened as international borders closed. The level of medical herb exports correlated negatively with the COVID-19 pandemic.

COVID-19 also harmed edible fungus, horticultural, oilseed, and edible oil products. Due to the transportation shutdown, the labour force could not migrate to other sectors. The authors propose that the government should aid and subsidize this sector.

Lu et al. (2020) studied China's social policies in the presence of COVID-19. COVID-19 had many adverse effects on China's economy, such as slowing industrial growth, decreasing GDP, reducing national exports and imports, and increasing unemployment. The author explored how the Chinese government provides financial assistance, social insurance, and social welfare. People receive social, medical, pension, and unemployment benefits. In this COVID-19 pandemic, special medical, educational, and legal aid was available. The author also stated that China's government provided special assistance to children and disabled people.

### 2.1. COVID-19 and Chinese Economy

The economic condition and its involvement in international trade make China important for all other countries. The financial or manufacturing fluctuations in China can disturb the trade balance globally. The current situation of COVID-19 hit the Chinese economy badly, and it also negatively impacted other economies around the world. Manufacturing activities stopped when COVID-19 spreads around the countries. The social distancing rules cause the underutilization of labour and capital in China, increasing the cost of production. Moreover, shutting down international borders and other transportation restrictions made the exports difficult for China, and it suffered huge losses, such as a reduction in its exports by 3.7% (Liu and Hu 2020).

Figure 1 presents the export trends of the Chinese economy from 2017 to December 2020. The figure shows that exports of China remarkably declined in January 2020 due to the worst period of the COVID-19 pandemic. Then the passage of time and development of precautions against COVID-19 made a positive impact on the exports of China. By the end of 2020, exports were at their highest level.



**Figure 1.** Exports of China. Source: The figure reproduced with permission from (National Bureau of Statistics of China 2021).

It is also seen that during the worst time of the pandemic, there was a remarkable decline in the investment sector, and extensive stock of the automobile industry remains unsold. The outbreak of COVID-19 caused the reduction of foreign direct investment, tourism, and other business trips. COVID-19 has the property of quick spread among people, so the government of China strictly followed the advisory of social distancing (Wong et al. 2020). Further preventions were taken, such as closing educational activities, private and government businesses, non-governmental organizations, and international trade. However, necessities and lifesaving commodities can transfer at the international level. The only objective of these measures is to minimize the spread of COVID-19, and China achieved this objective by these measures (Liu et al. 2020). Before COVID-19, the world faced many other types of pandemics and suffered the loss of massive deaths (Keogh-Brown et al. 2020). However, the COVID-19 spread quickly and covered the entire world. Many researchers, such as Allen et al. (2008), suggested that an increase in globalization and more trade of animals always have a more significant possibility of transmitting diseases. However, Keogh-Brown et al. (2020) explored the negative impacts of COVID-19 and suggested that the current pandemic is the most harmful and deadly. As COVID-19 compared to the previous pandemics and the number of death given in Table 1. Many studies used different variables to measure COVID-19, such as total cases of COVID-19, death rate, and total patients that recovered from COVID-19 (Alfani and Murphy 2017).

**Table 1.** Pandemic a historical perspective.

Pandemic Name	Number of Deaths	Time Duration
Black Death	75,000,000	1331 to 1351
Plague of Italy	281,000	1623 to 1632
Plague of Seville	2,000,000	1647 to 1652
London great Plague	100,000	1665 to 1666
Marseille Plague	110,000	1720 to 1722
Cholera	100,000	1816 to 1826
Cholera (2nd Pandemic)	100,000	1829 to 1851
Cholera in Russia	1,000,000	1852 to 1860
Flue Pandemic worldwide	1,000,000	1889 to 1890

Table 1. Cont.

Pandemic Name	Number of Deaths	Time Duration
Cholera (6th Pandemic)	800,000	1899 to 1923
Pandemic of Encephalitis Lethargica	1,500,000	1915 to 1926
Flu of Spanish	100,000,000	1918 to 1920
Asian Flue	2,000,000	1957 to 1958
H1N1 pandemic	205,000	2009 to 2010

Source: Plague and lethal epidemics in the pre-industrial world.

## 2.2. Short-Term and Long-Term Impacts of COVID-19 and the Chinese Economy

The epidemic of COVID-19 made many short-term and long-term shocks, and there are many types of research, such as [Chen et al. \(2020\)](#) and [Liu et al. \(2020\)](#), exploring the COVID-19 impacts and government policy of this pandemic. In a short-term analysis, the Chinese government took many emergency steps in response to COVID-19. The isolation and social distancing policies negatively impacted the domestic demand for commodities, such as decreased domestic demand. Moreover, the global market of Chinese products also decreases due to isolation and social distance policies. The categories of stages by which we can divide the impact of COVID-19 are as follows.

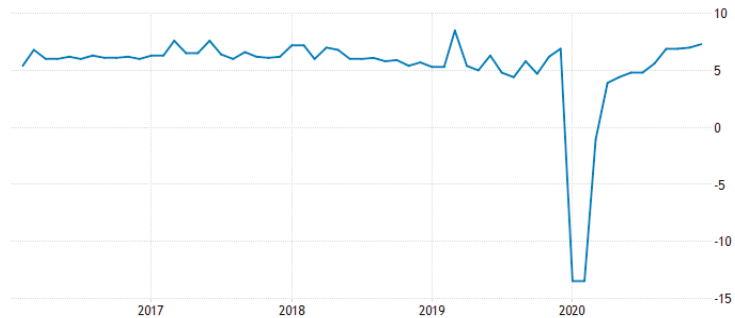
The first stage substantially negatively impacted consumption because it was a spring festival. All type of shopping malls was closed during this period, so there was a remarkable reduction in the consumption of commodities. Moreover, tourism, industrial, and retail activities were minimized, negatively impacting the country's consumption level. The restaurant and hoteling sectors suffered a lot, and about 93% of catering companies closed their business due to low demand for their services and goods.

The second stage comes right after the spring festival, and workers have to return to their careers, but due to COVID-19, they were unable to perform their duties. This caused the reduction of the production of commodities; moreover, less availability of transportation makes the transfer of the labour force impossible. So, the industrial sector suffered a lot from social distancing initiatives. The statistics indicate that about 50 million workers could not travel to their work due to isolation policies. Thus, this created unemployment and diminished the standard of living in China ([Liu and Hu 2020](#)).

The worldwide spread of COVID-19 referred to the third stage, and the demand for Chinese products reduced at the global level. Developed and developing nations strictly followed the policies and precautions suggested by the WHO about isolation. So, worldwide policies of isolation and social distancing put the borders close, then caused a substantial negative impact on Chinese international trade. The blowout of COVID-19 in the USA and European countries caused a considerable decline in the demand for Chinese products ([Shen et al. 2020](#)).

In the early months of 2020, such as January and February, China's macroeconomic information indicated negative development since measurements became accessible. Among these statistics, value-added to the modern industrial sector diminished by 13.5%. The services sector recorded a reduction of 13.0%, and absolute retail deals of social customer merchandise decreased by 20.5%. To forestall and stop COVID-19, China has paid a hefty monetary cost.

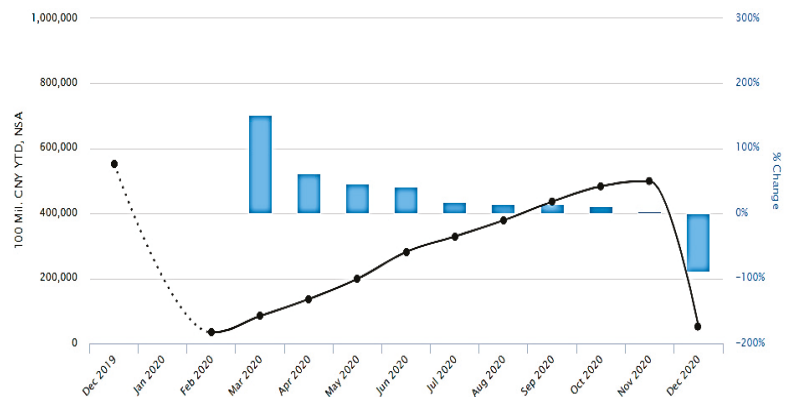
Figure 2 presents the industrial production growth trends of the Chinese economy from 2017 onward. The figure shows that industrial production of China remarkably declined after mid-2019 due to the worldwide spread of COVID-19. The demand for Chinese products declined mainly due to social distancing and the lockdown of international borders. Then the passage of time and development of precautions against COVID-19 positively impacted the industrial sector of China. By the end of 2020, industrial sector performance was at its highest level.



**Figure 2.** Industrial production of China. Source: The figure reproduced with permission from (National Bureau of Statistics of China 2021).

After the flare-up of COVID-19, China immediately dispatched a bundle of plans. To guarantee “hostile to plague”, the general public effectively gave cash and materials to guarantee “hostile to plague,” and the Chinese government immediately organized particular reserves. Simultaneously, the Chinese government has additionally declared different approaches, including financial arrangements, charge strategies, money-related arrangements, modern strategies, and business strategies. Regarding monetary interpretation, a blend of duty decrease, expense decrease, and endowments was given, and “Against Epidemic Thematic Bond” was given. The government has given particular treatment to businesses influenced by the plague, e.g., transportation, catering, travel, convenience, expedited service, standard avionics, and different companies. As indicated by fundamental gauges, the overall population spending shortage rate in 2020 may increase from 2.8% of GDP to about 3%.

Figure 3 explores the nominal fixed investment trends for the Chinese economy between the years 2019 and 2020. The figure shows that investment in China remarkably declined due to the outbreak of COVID-19. Then the passage of time and development of precautions against COVID-19 had a positive impact on the investments of China. By the end of 2020, it had a negative growth rate, and COVID-19 also had a low growth rate.

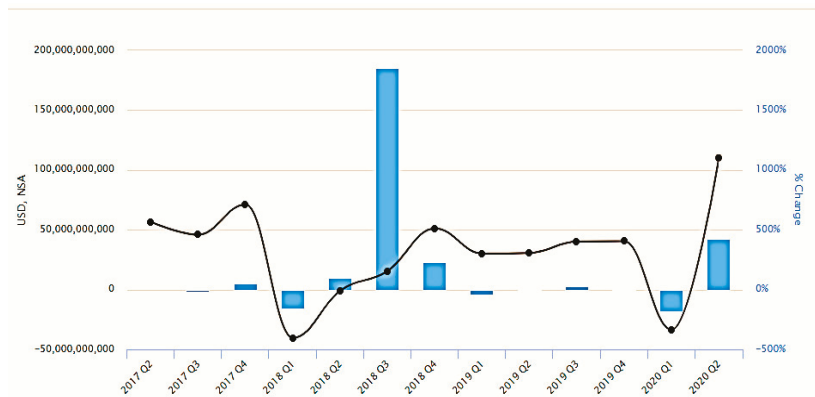


**Figure 3.** Nominal Fixed Investments. Source: The figure reproduced with permission from (National Bureau of Statistics of China 2021).

Regarding the financial approach, it has additionally kept up enough for free. Through measures like balance sheet expansion, reserve requirement ratio RRR-cutting, and strategy loan cost-cutting, the People’s Bank of China (POBC) guarantees adequate liquidity and no expansion in financing costs for the real economy, simultaneously as financial strength.

As of now, the focal banks unique enemy of scourge renegotiating portion has arrived at 800 billion Yuan. Simultaneously, under the state of impeded outside interest and the level foreign trade holds, PBOC focused on RRR-slicing to help develop all-out social financing. A more straightforward improvement plan comes from a “new framework.” In a request to battle the negative effects of COVID-19, as of in 1 March 2020, 13 territories, including Beijing, have delivered venture plans for critical activities in 2020 with up to 33.8 trillion Yuan. Among them, “new foundation” is exceptionally anticipated. “New framework” is unique concerning the customary foundation, for example, railroad, parkway, air terminal, and primarily incorporates seven perspectives: “5G foundation, UHV, intercity rapid rail line and metropolitan rail travel, new energy vehicle charging heaps, huge server farms, man-made consciousness, mechanical Internet” (Chen et al. 2020).

Figure 4 presents the trade balance of the Chinese economy from 2017 to quarter 2 of 2020. Figure 4 shows that China’s trade balance declined with the outbreak of COVID-19, such as in 2019, due to the severe conditions of COVID-19. Then, the passage of time and the development of precautions against COVID-19 positively impacted China’s trade balance. By the end of 2020, the trade balance had a positive figure, showing that the implications of COVID-19 were minimized.



**Figure 4.** Current account balance. Source: National Bureau of Statistics of China The figure reproduced with permission from (National Bureau of Statistics of China 2021).

Regarding business strategy, the public authority decreased the trouble on endeavours through the expense and charge decrease arrangements from one perspective. Then again, the public administration is effectively extending business channels. These channels incorporate developing enrollment plans for state-possessed undertakings, growing business at the grassroots level (for example, supporting agribusiness, instruction, clinical consideration, and destitution lightening, and so on), extending the size of business learners, sorting out “Cloud” job fairs for graduates, and properly postponing acknowledgment. It tends to be seen that under the extreme effects of the plague, China has consistently embraced general wellbeing approaches, financial arrangements, money-related strategies, mechanical approaches, and business arrangements, which are exceptionally focused on and very ground-breaking. Consequently, this paper will generally accept that the prior quarter ought to be the lower part of the transient economy. Afterward, it will show a “base bounce back what is more, generally adequacy”. Consistently, the probability of finishing the business and development targets set by the Central Economic Work Conference stays high. What is more, on the planet, the more noteworthy recuperation of China’s economy is expected to lead to the worldwide economy’s recovery (Zhao et al. 2020).

### 3. Materials and Method

The study's primary purpose is to show the impact of COVID-19 on China's economic growth. We obtained monthly data from China from January 2019 to December 2020, and the data is obtained from WHO, World Development Indicators (WDI), and the Chinese economy.

#### 3.1. Econometric Estimation

Different econometric techniques are used for estimation of analyses. These stepwise econometric techniques are detailed below:

##### Unit Root Analyses

Different unit root tests check the model of the variables for China to detect integration on both variables. The trial of [Levin et al. \(2002\)](#) is begun by way of the Augmented Dickey Fuller (ADF) Equations (1) and (2) that engages the ordinary procedure of the panel unit root survival through the payment of conflicting lag order integration in cross-sections of the panel. The null hypothesis (H0) indicates the non-stationarity, whereas the Alternate Hypothesis (H1) indicates the stationary series.

$$\Delta y_{it} = \alpha_0 y_{it-1} + \sum_{p=1}^{ni} a_{1ip} \Delta y_{it-p} + \lambda_{it} + \varepsilon_{it} \quad (1)$$

$$a_0 = n - 1$$

[Im et al. \(2003\)](#) a panel unit identifies the ADF of each class of panel assigned to a particular forum by measuring the average t-statistics of ADF statistics  $\bar{t}_{NT}$  with a zero interval in the above Equation (1) of the ADF, it has been pointed out that [Im et al. \(2003\)](#) indicates the critical values stated in each class ( $n$ ) and the length of the series and for the variables that are implanted by constant or by constant with trend to each other. For non-zero intervals, it indicates that the normal distribution is given in the Equation (2) below [Im et al. \(2003\)](#).

$$X_{\bar{t}_{NT}} = \frac{\sqrt{P} \left[ \bar{t}_{NT} - N^{-1} \sum_{i=1}^N F(\bar{t}_{NT}(N_i)) \right]}{N^{-1} \sum_{i=1}^N \text{var}(\bar{t}_{it}(N_i))} \quad (2)$$

where is the mean;  $\text{var}(\bar{t}_{it}(N_i))$  is the variances of the ADF regression of t-statistic  $F(\bar{t}_{NT}(N_i))$  caused to be by [Im et al. \(2003\)](#), with reverence of various lags, series lengths, and the assumptions that support different test equations.

#### 3.2. Model Specification

In recent decades, the Chinese economy has been tormented with air contamination ([Zhang et al. 2020](#)) because of massive industrialization and anthropogenic exercises. To this end, the current investigation endeavours to approve an immediate connection between financial development and fossil fuel byproducts in China somewhere in the range of 2019 and 2020, to set up the flexibility connection between fossil fuel byproducts and economic development for strategy detailing. We additionally investigate the effect of financial, social, and political globalization on economic growth and the impact of imprisonment, disconnecting both monetary and social globalization. We expect that fossil fuel byproducts immediately affect financial development as filthy information ([Bekun et al. 2019](#)). All in all, we hope to affirm that rising fossil fuel byproducts will prompt climbing economic development ([Cogollo et al. 2020](#)) to decide the versatility connection between these factors and actuate the effect of the decrease in fossil fuel byproducts on economic growth in China during the 2020 repression.

**Hypothesis (H0).** *There is an unknown relationship between COVID-19 and the GDP of China.*

**Hypothesis (H1).** *There is a positive relationship between COVID-19 and the GDP of China.*

**Hypothesis (H2).** *There is a negative relationship between COVID-19 and the GDP of China.*

The present study analyzes the effect of COVID-19 on the economy of China, and it also studies whether economic and social activities in China, a highly industrialized nation, generate pollution emissions. For this purpose, many studies explain this relationship (Shittu et al. 2021).

**Hypothesis (H3).** *Economic and social isolation adversely affects Chinese economic growth due to the COVID-19 pandemic.*

The central hypothesis that describes the Sustainable Development Goals-3 of the health sector is that health is a primary necessity, and each country focuses on health prosperity. In the context of the global pandemic for the case of China, the present study seeks to understand the effect of social isolation and its implications on economic growth while considering health status.

Our primary model represents the effects of both economic and social globalization and is isolated. To understand the lockdown assumed by the Chinese administration during the COVID-19 crisis, a model from Zhang and Hu (2021) is followed.

For this purpose, our model is given below:

$$GDP_t = \alpha_0 + \alpha_1 CO_2_t + \alpha_3 EG_t + \alpha_4 SG_t + \alpha_5 PG_t + \epsilon_{it}$$

GDP = gross domestic product

CO<sub>2</sub> = per capita carbon emission

EG = economic globalization

SG = social globalization

PG = political globalization

## 4. Results and Discussion

### 4.1. Statistical Analysis

The primary purpose of our study is to investigate the impact of COVID-19 on the Chinese economy. The table shows the descriptive statistical analysis of the variables which are chosen for the model.

#### Descriptive Statistics

In data analysis and estimation of the model, descriptive analysis always assists in understanding the data, giving the mean, median, mode, standard deviation minimum, and maximum values of variables. This analysis helps the researchers by depicting the range and essential characteristics of data. So, Table 2 presents the mean, median, standard deviation, minimum, and maximum values of all variables.

**Table 2.** Descriptive Statistics.

Variable	Obs	Mean	Std. Dev	Min	Max
GDP	24	2.47	1.62	−2.53	4.75
SG	24	60.16	23.09	15.16	98.18
CO <sub>2</sub>	24	1.63	0.78	0.46	3.40
EG	24	21.34	1.50	17.80	23.67
PG	24	21.02	1.36	18.38	23.14

Source: Authors calculations based on EViews 12.0.

Descriptive analysis is wholly explained in Table 2. Table 2 has 24 observations of each of the variables. GDP, SG, CO<sub>2</sub>, and EG are variables. The dependent variable is GDP, whereas the independent variables are SG, CO<sub>2</sub>, and EG. The mean value of GDP is

2.47 with a typical value of 1.62, and the mean value of social globalization is 60.16 with a standard deviation of 23.09. The mean value of CO<sub>2</sub> is 1.63 with a standard deviation of 0.78, and the mean value of economic globalization is 21.34 with a standard deviation of 1.50.

Table 2. Clearly depicts 24 observations, and the third column shows the central tendency of every variable. The standard deviation shows the dispersion by which data lies from its central value and t. The minimum and maximum values help determine the data ranges of variables used in the study.

#### 4.2. Correlation Analysis

Correlation analysis helps to show the association among all variables, and this analysis gives relevant results about association among variables (Cohen 2013). Table 3 presents the correlation matrix that clears the relationship strength among all variables. Moreover, correlation analysis further assists in knowing whether variables are perfectly correlated or not. The nonexistence of perfect correlation considers well-organized data used in further analysis.

**Table 3.** Correlation Matrix.

	GDP	SG	CO <sub>2</sub>	EG	PG
GDP	1.00				
SG	27	1.00			
CO <sub>2</sub>	27	0.12	1.00		
EG	27	−0.56	0.41	1.00	
PG	27	−0.63	0.39	0.96	1.00

Source: Author's calculations based on EViews 12.0.

Table 3 clearly suggests that all variables are associated with each other; however, there is not enough evidence about the presence of perfect multi-correlation. The value 1 shows the perfect correlation, but not a single variable is perfectly correlated. Therefore, we can trust this model and use it in regression analysis.

#### 4.3. Unit Root Test

This section of the study utilizes unit root tests to identify the stationary level of the data set of a variable. The previous chapter detailed discussion about untaken unit root tests, and here we execute the unit root test. Different unit root tests are available, such as ADF (Augmented. Dickey-Fuller), PP (Phillips-Perron), Levin and Chu, and IPS unit root tests. For this study, ADF and PP tests of the unit root are performed to check the stationary of the data set. Accurate estimation of a dataset requires constant mean and variance that is independent of time; moreover, this situation leads to a stationary dataset.

Table 4 shows the results of the ADF test, and the unit root test is applied on variables separately. All variables are stationary at a level, so the order of integration is I(0), and we can suggest that there is no issue of a unit root. Moreover, some variables are significant at 2%, and the remaining are significant at a 5% or 10% level of significance. Foreign direct investment, GDP growth rate, and inflation rate are significant at a 2% level of significance. The other variables, including CO<sub>2</sub>, EG, SG, and PG, are significant at a 5% level of significance. These results suggest that ordinary least square (OLS) is an accurate estimation method because variables are stationary at level.



**Table 4.** ADF Unit Root test.

Variable	LEVEL		First Difference		Order of Integration
	Intercept	Trend and Intercept	Intercept	Trend and Intercept	
GDP	−3.30 *	−3.44 **	−7.26 *	−7.18 **	I(0)
SG	−0.45	−1.93 **	−5.57 *	−5.63	I(0)
CO2	−3.43 *	−3.35 **	−5.16 *	−5.11 *	I(0)
EG	−2.57	−2.93 **	−4.09 *	−4.03	I(0)
PG	−2.95 **	−3.38 ***	−3.54 *	−3.50 **	I(0)

Source: Authors estimation based on EViews 12.0. H0: indicates the stationary dataset that is the null hypothesis (absence of unit root). Critical values are 10%, 5%, and 2%, and values of LM less than critical values indicate the acceptance of H0 (null hypothesis). This is again the case because the dataset has no unit root. \* Significant at 10% level of significance. \*\* Significant at 5% level of significance. \*\*\* Significant at 1% level of significance.

Table 5 presents the PP (Phillips Perron) test results, and the unit root test is applied on variables separately. All variables are stationary at a level, so the order of integration is I(0), and we can suggest that there is no issue of a unit root. Moreover, some variables are significant at 2%, and the remaining are significant at a 5% level of significance. Foreign direct investment, GDP growth rate, and inflation rate are significant at a 2% level of significance. The other variables, external debt, gross fixed capital formation, gross capital formation, and unemployment rate, (CO<sub>2</sub>, PG, SG, EG) are significant at a 5% level of significance. So, these results suggest that OLS (Ordinary least square) is an accurate estimation method because variables are stationary at level.

**Table 5.** PP Unit Root test.

Variable	LEVEL		First Difference		Order of Integration
	Intercept	Trend and Intercept	Intercept	Trend and Intercept	
GDP	−3.32 *	−3.34 *	−8.24 *	−8.06 *	I(0)
SG	−0.35	−1.93 **	−5.58 *	−5.69 *	I(0)
CO <sub>2</sub>	−2.17 **	−2.23 **	−10.08 *	−5.11 *	I(0)
EG	−2.11	−2.73 **	−4.09 *	−4.03	I(0)
PG	−3.21 **	−3.67 **	−3.74 *	−3.60 **	I(0)

Source: Author's estimation based on EViews 12.0. H0: indicates the stationary data set that is the null hypothesis (absence of unit root). Critical values are 10%, 5%, and 2%, and values of LM less than critical values indicate the acceptance of H0 (null hypothesis). This is again the case data set has no unit root. \* Significant at 10% level of significance. \*\* Significant at 5% level of significance.

#### 4.4. Estimation of Model

Table 6 represents the panel OLS regression results. The results indicate that economic growth and CO<sub>2</sub> have a positive relationship and are highly significant. It demonstrates that if CO<sub>2</sub> increases in China, economic growth also increases. The result indicates that if 1% increases in CO<sub>2</sub>, then 3.69 units increase in the economic development of these countries. Economic globalization has a positive and significant impact on economic growth, and it indicates that if economic globalization increases in China, economic growth also increases. The result indicates that if a 1% increase occurs in economic globalization, then 3.40 units increase in economic growth. The results indicate that all the variables have positive and highly significant impacts on economic growth. The R square shows that these independent variables' change in economic growth is 87%.

**Table 6.** Estimation of Model.

Dependent Variable GDP Growth				
Variable	Coefficient	Std. Err	t Value	Prob.
SG	0.030	0.2185	0.137	0.892 ***
CO <sub>2</sub>	3.693	0.3696	9.991	0.000 *
EG	3.40	0.426	7.98	0.000 *
PG	0.243	0.134	1.813	0.084 **
cons	4.09	6.57	0.62	0.54 ***
Number of obs	24			
R-squared	0.87			
Adj R-squared	0.83			

Source: Author's calculations based on EViews 12.0. \* Result is significant at a 2% level of significance. \*\* Result is significant at a 5% level of significance. \*\*\* Result is significant at a 10% level of significance.

#### 4.5. Diagnostic Tests

Table 7 explains the Wald test, which discusses the heteroscedasticity presence/absence in data. The F statistic value is 7.984160, the probability of F-statistic is 0.000, the chi-square value is 39.92080, and its possibility is 0.000.

**Table 7.** Wald Test.

Test Statistic	Value	df	Probability
F-statistic	7.984160	(5, 127)	0.0000
Chi-square	39.92080	5	0.0000

Author's calculation by EViews 9.5.

#### 4.6. Breusch–Pagan Test for Heteroskedasticity

The presence of heteroskedasticity in a dataset can mislead the results, and we can rely on these results in policy-making or recommendations. Different tools and tests detect heteroskedasticity, but Breusch–Pagan is a significant test for the time series data set. Many previous studies used the same technique to detect the presence of heteroskedasticity, and among these studies (Halunga et al. 2017) can use as reference. The condition of Homoscedasticity indicates that error terms have the same or constant variance that is the fundamental property of CLRM. In applying this test, we have to make null and alternative hypotheses where the null hypothesis suggests there is no heteroskedasticity. On the other hand, Ha or the alternative hypothesis shows the presence of heteroskedasticity in the data set.

$$H_0 = \sigma_1^2 = \sigma_2^2 = \dots = \sigma^2$$

$$H_0 = \sigma_1^2 \neq \sigma_2^2 = \dots \neq \sigma^2$$

So:

Null hypotheses  $H_0$  = reschedules are not heteroscedastic, or there is no presence of heteroskedasticity

Alternative hypothesis  $H_a$  = the variance of error term does not contact or presence of heteroskedasticity.

Table 8 indicates that the prob. value of F statistics is 0.72 and prob values are 0.65, 0.57, and 0.91. Some values did not meet the minimum 5%, 2%, and 10% significance levels. Therefore, we have enough proof to accept the null hypothesis and conclude there is no presence of heteroskedasticity. The error term has a constant variance of data series, and we can use this dataset in other estimations.

**Table 8.** Breusch–Pagan test for heteroskedasticity.

Breusch-Pagan Test			
F Statistics	0.72	Prob F	0.65
Obs R Squared	5.70	Prob Chi-square7	0.57
Scaled Explained SS	2.67	Prob Chi-square7	0.91

Source: Author's calculations based on EViews 12.0.

## 5. Conclusions

The coronavirus pandemic that has ravaged China since December 2019 has put its economy to the test. China's GDP grew 5.94% in 2019 to \$142.29.94 billion. China's economy shrank 6.8% in Q1 2020 due to nationwide lockdowns during the COVID-19 outbreak. It was the first decline since Beijing began reporting quarterly GDP in 1992. Then China's economy recovered from the COVID-19 pandemic. The National Statistics Bureau reported that China's gross domestic product increased 6.5% in the fourth quarter of 2020, exceeding the 6% growth rate in late 2019 before the Coronavirus took hold. China's economy grew by 2.3% in 2020, becoming the only major economy to do so during a year of global devastation. Like the United States, Europe, India, and Japan, other major nations and geopolitical competitors are battling a winter wave. In 2020, China's GDP will reach 100 trillion Yuan (15 trillion USD). With the pandemic over, innovation and digitization reignited China's economic growth. The economy grew 18.3% year-on-year in the first quarter of 2021. It's the most significant GDP increase since China began tracking quarterly GDP in 1992. China's GDP grew 7.9% in the second quarter and 2.3% in the third quarter compared to last year. China's economy is expected to grow by 5.5% in the fourth quarter and by 8.5% this year. As low base effects fade and the economy returns to its pre-COVID-19 trend growth, next year's growth is expected to slow to 5.4% (Tian 2021).

As a result, the stationarity of fossil fuel byproducts determines the approaches value. Our study also has limitations because it does not consider the impacts of specialized power use (Sanzo-Perez et al. 2017). In any case, the current study focuses on the GDP flexibilities of fossil fuel byproducts and how the globalization interaction is measured. If we only consider fossil fuel byproducts as a financial development result, our experimental results may be misleading (Liu 2021). The effects of monetary and social globalization are also considered. The absence of monetary and social globalization is due to the Chinese experts financial disengagement caused by the COVID-19 flare-up.

**Author Contributions:** Conceptualization, methodology, software, and validation: Z.H.; formal analysis: Z.H.; investigation: Z.H.; resources: Z.H.; data curation: Z.H.; writing—original draft preparation: Z.H.; writing—review and editing: Z.H.; visualization: H.H.; supervision: H.H.; project administration: M.A.M.; funding acquisition: M.A.M. All authors have read and agreed to the published version of the manuscript.

**Funding:** This research received no external funding.

**Institutional Review Board Statement:** Not applicable.

**Informed Consent Statement:** Not applicable.

**Data Availability Statement:** The data presented in this study are available on request from the corresponding authors.

**Acknowledgments:** The authors warmly thank friends and colleagues for their continuous support and advice over the years.

**Conflicts of Interest:** The authors declare no conflict of interest. The funders had no role in the design of the study, in the collection, analyses, or interpretation of data, in the writing of the manuscript, or in the decision to publish the results.

## References

- Alfani, Guido, and Tommy E. Murphy. 2017. Plague and lethal epidemics in the pre-industrial world. *The Journal of Economic History* 77: 314–43. [CrossRef]
- Allen, Linda, Fred Brauer, Pauline Van den Driessche, and Jianhong Wu. 2008. *Mathematical Epidemiology, Volume 1945 of Lecture Notes in Mathematics*. Berlin: Springer, vol. 13, p. 14.
- Bekun, Festus Victor, Firat Emir, and Samuel Asumadu Sarkodie. 2019. Another look at the relationship between energy consumption, carbon dioxide emissions, and economic growth in South Africa. *Science of the Total Environment* 655: 759–65. [CrossRef] [PubMed]
- Chen, Jingjing, Wei Chen, Ernest Liu, Jie Luo, and Zheng Michael Song. 2020. *The Economic Impact of COVID-19 in China: Evidence from City-to-City Truck Flows*. Beijing: School of Economics and Management, Tsinghua University.
- Clinics, Mayo. 2020. Coronavirus Disease 2019 (COVID-19). Available online: <https://www.mayoclinic.org/diseases-conditions/coronavirus/symptoms-causes/syc-20479963> (accessed on 15 November 2020).
- Cogollo, Mar, Pedro M. Balsalobre, Andres Diaz Lantada, and Héctor Puago. 2020. Design and experimental evaluation of innovative wire-to-plane fins' configuration for atmosphere corona-discharge cooling devices. *Applied Sciences* 10: 1010. [CrossRef]
- Cohen, Jacob. 2013. *Statistical Power Analysis for the Behavioral Sciences*. Cambridge: Academic Press.
- Craven, Matt, Shubham Singhal, and Matthew Wilson. 2020. *COVID-19: Briefing Note*. Bengaluru: McKinsey & Company, April 13.
- Dhar, Bablu Kumar. 2020. Impact of COVID-19 on Chinese Economy. *Economic Affairs* 9: 23–26.
- Halunga, Andreea G., Chris D. Orme, and Takashi Yamagata. 2017. A heteroskedasticity robust Breusch–Pagan test for Contemporaneous correlation in dynamic panel data models. *Journal of Econometrics* 198: 209–30. [CrossRef]
- Im, Kyung So, Mohammad Hashem Pesaran, and Yongcheol Shin. 2003. Testing for unit roots in heterogeneous panels. *Journal of Econometrics* 115: 53–74. [CrossRef]
- Islam, Md, Arifa Jannat, Dewan Abdullah Al Rafi, and Kentaka Aruga. 2020. Potential Economic Impacts of the COVID-19 Pandemic on South Asian Economies: A Review. *World* 1: 283–99. [CrossRef]
- Keogh-Brown, Marcus R., Henning Tarp Jensen, William John Edmunds, and Richard D. Smith. 2020. The impact of Covid-19, associated behaviours and policies on the UK economy: A computable general equilibrium model. *SSM-Population Health* 12: 100651. [CrossRef]
- Kuckertz, Andreas, Leif Brändle, Anja Gaudig, Sebastian Hinderer, Carlos Arturo Morales Reyes, Alicia Prochotta, Kathrin M. Steinbrink, and Elisabeth S. C. Berger. 2020. Startups in times of crisis—A rapid response to the COVID-19 pandemic. *Journal of Business Venturing Insights* 13: e00169. [CrossRef]
- Levin, Andrew, Chien-Fu Lin, and Chia-Shang James Chu. 2002. Unit root tests in panel data: Asymptotic and finite-sample properties. *Journal of Econometrics* 108: 1–24. [CrossRef]
- Lin, Ben-Xi, and Yu Yvette Zhang. 2020. Impact of the COVID-19 pandemic on agricultural exports. *Journal of Integrative Agriculture* 19: 2937–45. [CrossRef]
- Liu, HaiYue, Aqsa Manzoor, CangYu Wang, Lei Zhang, and Zaira Manzoor. 2020. The COVID-19 outbreak and affected countries stock markets response. *International Journal of Environmental Research and Public Health* 17: 2800. [CrossRef] [PubMed]
- Liu, Kerry. 2021. COVID-19 and the Chinese economy: Impacts, policy responses and implications. *International Review of Applied Economics* 35: 308–30. [CrossRef]
- Liu, Zhiyi, and Biliang Hu. 2020. China's economy under COVID-19: Short-term shocks and long-term changes. *Modern Economy* 11: 908–19. [CrossRef]
- Lu, Li, Junlin Peng, Jing Wu, and Yi Lu. 2021. Perceived impact of the Covid-19 crisis on SMEs in different industry sectors: Evidence from Sichuan, China. *International Journal of Disaster Risk Reduction* 55: 102085. [CrossRef]
- Luo, Ren-Fu, Cheng-Fang Liu, Jing-Jing Gao, Tian-Yi Wang, Hua-Yong Zhi, Peng-Fei Shi, and Ji-Kun Huang. 2020. Impacts of the COVID-19 pandemic on rural poverty and policy responses in China. *Journal of Integrative Agriculture* 19: 2946–64. [CrossRef]
- Lu, Quan, Zehao Cai, Bin Chen, and Tao Liu. 2020. Social policy responses to the Covid-19 crisis in China in 2020. *International Journal of Environmental Research and Public Health* 17: 5896. [CrossRef]
- Meng, Lingzhong, Fang Hua, and Zhuan Bian. 2020. Coronavirus disease 2019 (COVID-19): Emerging and future challenges for dental and oral medicine. *Journal of Dental Research* 99: 481–87. [CrossRef]
- National Bureau of Statistics of China. 2021. Available online: <http://www.stats.gov.cn/english/> (accessed on 26 January 2021).
- Qiu, Jane. 2021. MIT Technology Review. Available online: <https://www.technologyreview.com/tag/coronavirus-covid-19-news/> (accessed on 19 November 2021).
- Sanzo-Perez, María José, Marta Rey-García, and Luis Ignacio Álvarez-González. 2017. The impact of professionalization and partnerships on nonprofit productivity. *The Service Industries Journal* 37: 783–99. [CrossRef]
- Shen, Huayu, Mengyao Fu, Hongyu Pan, Zhongfu Yu, and Yongquan Chen. 2020. The impact of the COVID-19 pandemic on firm performance. *Emerging Markets Finance and Trade* 56: 2213–30. [CrossRef]
- Shittu, Waliu, Festus Fatai Adedoyin, Muhammad Ibrahim Shah, and Hamed Oluwaseyi Musibau. 2021. An investigation of the nexus between natural resources, environmental performance, energy security and environmental degradation: Evidence from Asia. *Resources Policy* 73: 102227. [CrossRef]
- Tian, Wei. 2021. How China managed the COVID-19 pandemic. *Asian Economic Papers* 20: 75–101. [CrossRef]
- Wang, Qiang, and Min Su. 2020. A preliminary assessment of the impact of COVID-19 on environment—A case study of China. *Science of the Total Environment* 728: 138915. [CrossRef] [PubMed]

- Wei, Panpan, Cheng Jin, and Chen Xu. 2021. The Influence of the COVID-19 Pandemic on the Imports and Exports in China, Japan, and South Korea. *Frontiers in Public Health* 9: 682–93. [CrossRef]
- WHO. 2020. Q&A: How Is COVID-19 Transmitted? Available online: <https://www.who.int/vietnam/news/detail/14-07-2020-q-a-how-is-covid-19-transmitted> (accessed on 17 September 2021).
- Wong, Ho Yuen Frank, Hiu Yin Sonia Lam, Ambrose Ho-Tung Fong, Siu Ting Leung, Thomas Wing-Yan Chin, Christine Shing Yen Lo, Macy Mei-Sze Lui, Jonan Chun Yin Lee, Keith Wan-Hang Chiu, Tom Wai-Hin Chung, and et al. 2020. Frequency and distribution of chest radiographic findings in patients positive for COVID-19. *Radiology* 296: E72–E78. [CrossRef]
- Yang, Haochang, and Peidong Deng. 2021. The impact of COVID-19 and government intervention on stock markets of OECD countries. *Asian Economics Letters* 1: 18646. [CrossRef]
- Yu, Meng, Zhiyong Li, Zhicheng Yu, Jiixin He, and Jingyan Zhou. 2021. Communication related health crisis on social media: A case of COVID-19 outbreak. *Current Issues in Tourism* 24: 2699–705. [CrossRef]
- Zhang, Qian Forrest, and Zhanping Hu. 2021. Rural China under the COVID-19 pandemic: Differentiated impacts, rural–urban inequality and agro-industrialization. *Journal of Agrarian Change* 21: 591–603. [CrossRef]
- Zhang, Yumei, Xinshen Diao, Kevin Z. Chen, Sherman Robinson, and Shenggen Fan. 2020. Impact of COVID-19 on China’s macroeconomy and agri-food system—an economy-wide multiplier model analysis. *China Agricultural Economic Review* 12: 387–407. [CrossRef]
- Zhao, Qianwen, Meng Meng, Rahul Kumar, Yinlian Wu, Jiaofeng Huang, Yunlei Deng, Zhiyuan Weng, and Li Yang. 2020. Lymphopenia is associated with severe coronavirus disease 2019 (COVID-19) infections: A systemic review and meta-analysis. *International Journal of Infectious Diseases* 96: 131–35. [CrossRef]

Article

# Impact of COVID-19 on the Russian Labor Market: Comparative Analysis of the Physical and Informational Spread of the Coronavirus

Dmitriy Rodionov <sup>1</sup>, Anastasia Ivanova <sup>1</sup>, Olga Konnikova <sup>2</sup> and Evgenii Konnikov <sup>1,\*</sup>

<sup>1</sup> Graduate School of Industrial Economics, Peter the Great St. Petersburg Polytechnic University, 195251 Saint Petersburg, Russia; rodion\_dm@mail.ru (D.R.); nastyai.ivanov@yandex.ru (A.I.)

<sup>2</sup> Department of Marketing, Saint-Petersburg State University of Economics, 191023 Saint Petersburg, Russia; olga.a.konnikova@gmail.com

\* Correspondence: konnikov.evgeniy@gmail.com; Tel.: +7-9618084582

**Abstract:** The aim of the article is to investigate the impact of the new coronavirus infection on the Russian labor market and to suppose the actions to be taken to minimize negative economic consequences. The distinctiveness of this study is the differentiation of the impact of the physical and informational spread of COVID-19. The informational spread of coronavirus is measured through the dynamics of news messages related to the topic of “coronavirus” in the largest Russian media. The analysis of the average level of wages by type of economic activity, as well as the demand of employers and the number of vacancies, allow testing the hypothesis that the physical and informational spread of coronavirus caused an increase in the number of unemployed, a decrease in average wages in the studied range of economic activities, an increase in supply on the labor market, and a decrease in demand for employees. Another task of the study is to assess the dynamics of related search queries in Yandex (Russian biggest search engine), which can help to reveal the logic in the behavior of the Russian people during the pandemic as well as to understand if the Russian economy, the labor market, and society were prepared for the changes caused by the pandemic. Using a regression modeling methodology, it was found that the influence of the information environment, namely the informational spread of coronavirus, had an even greater impact on studied parameters than the physical spread. A “delay effect of physical consequences” was discovered. The conclusions obtained showed that in the conditions of wide informatization of society, it is necessary to systematically influence the physical and informational spread of coronavirus to minimize the negative consequences of the pandemic on the labor market.

**Keywords:** COVID-19; labor market; informational spread of coronavirus; information environment

**Citation:** Rodionov, Dmitriy, Anastasia Ivanova, Olga Konnikova, and Evgenii Konnikov. 2022. Impact of COVID-19 on the Russian Labor Market: Comparative Analysis of the Physical and Informational Spread of the Coronavirus. *Economics* 10: 136. <https://doi.org/10.3390/economics10060136>

Academic Editor: Ștefan Cristian Gherghina

Received: 19 September 2021

Accepted: 26 May 2022

Published: 9 June 2022

**Publisher’s Note:** MDPI stays neutral with regard to jurisdictional claims in published maps and institutional affiliations.



**Copyright:** © 2022 by the authors. Licensee MDPI, Basel, Switzerland. This article is an open access article distributed under the terms and conditions of the Creative Commons Attribution (CC BY) license (<https://creativecommons.org/licenses/by/4.0/>).

## 1. Introduction

In the beginning of 2020, the world in general and Russia fell victim to a pandemic of a new virus—COVID-19. The virus changed the way of life incredibly and had a negative impact on the world economy. Instead of cooperation, it forced people into “social distancing” and “self-isolation”, which led to economic stagnation and forced many employees to leave their usual places of employment, acquiring the status of “unemployed”.

In the media and on social networks, panic began to grow at a rapid rate. Some industries were essentially paralyzed. Of course, it is too early to say that the crisis has gone away, however, society already has a certain amount of information about COVID-19, enabling to take certain steps to eliminate the consequences of the pandemic.

The spread of new coronavirus infections caused changes in the Russian labor market. In many respects, the forced introduction of interaction restrictions caused by the specificity of the virus led to a significant transformation of the production and consumption processes, which resulted in the disruption of many economic ties. These disruptions inevitably lead

to both a decrease in the volume of resource turnover in the economy and to its slowdown, which, in turn, resulted in a systemic slowdown in economic growth and a protracted recession. The specifics of the Russian economy lie in the fact that it belongs to the group of resource-rich and resource exporting transition economies dominated by the export of natural resources (especially oil and gas), which determines the specifics of the Russian labor market—it is largely more focused on international rather than on the domestic economy (Sadik-Zada 2020; Sadik-Zada et al. 2021). This caused the particular impact of the pandemic and the subsequent breakdown of supply chains on the Russian economy and the Russian labor market.

The urgency of the problem considered within this article lies in the need to take prompt measures to prevent the economic consequences of the pandemic. The solution to the problem is extremely relevant in the context of its global character.

Before going to the primary data set investigation, the theoretical and methodological basis of similar research interests was analyzed. Thus, it is worth highlighting a number of studies that have discovered the following key topics: technology development and innovations as one of the possible consequences of the pandemic; the impact of the information environment on society and economic processes during a pandemic; labor market changes under the influence of the coronavirus pandemic; and forecasts about possible ways of economic recovery.

To begin with, Tisdell (2020) underlined that throughout history, pandemic outbreaks have negatively affected the functioning of society, but also paradoxically cleared the way for innovations and achievements in science, economics, and political systems. As an example, he refers to the Black Death (the second-in history plague pandemic), which destroyed the division between upper and lower classes and led to the emergence of a new middle class. The author cites the idea that the coronavirus pandemic will help to accelerate the spread of Internet technologies for conferences, seminars, meetings, online training for social contacts, economic trade, and financial transactions. Forman et al. (2020) agree that the pandemic will lead to the development of technologies, as well as the increase of investments in human potential. Laing (2020) suggests that the pandemic may contribute to an increase in industrial process automation. Thus, the positive impact of the pandemic on the development of society is assumed. It was also hypothesized that due to the accelerated spread of Internet technologies, the interest of people in remote work, as well as in obtaining additional education based on Internet platforms, will only continue to increase.

Going deeper into the topic of the Internet environment, it is reasonable to consider the research by Almomani and Al-Qur'an (2020). The authors analyzed the information environment in the context of COVID-19. They argued that the introduction of restrictive measures to combat the spread of coronavirus, which resulted in social networks and online platforms becoming the most popular tool for social discussions, has had a devastating effect on the psychological state of society during the period of isolation. In the absence of any scientific evidence with reliable and comprehensive information about the new virus, rumors and fabricated news have affected the trust between the government and the public. The negative impact of the pandemic on the mental condition of people, as well as its influence on the economic sector, was reflected by Lyócsa et al. (2020). In this study, the authors conclude that stock markets around the world experienced a fall not so much because of the pandemic, but because of the fear of people about it. Researchers have proven that searching for information about the pandemic on Google correlates with price changes. Thus, during times of crisis, Google searches can be a valuable source of information for predicting stock price fluctuations. Within the framework of this topic, attention should be paid to the influence of the information environment on the real processes occurring in the economy. It should be checked how the informational spread of the coronavirus has affected supply and demand in the Russian market, and how the dynamics of average wages have changed under the influence of the information environment.

Considering studies on changes in the labor market under the influence of the pandemic, Adams-Prassl et al. (2020) emphasized the existence of a strong relationship between

the average share of tasks that employees can perform from home within their industry, and the percentage of employees who lost their jobs in the same industry during the pandemic. The greater the proportion of tasks performed from home, the less the employee is at risk of being fired. Thus, employees in the IT and related professions are least exposed to the risk of layoffs. The authors stated that the pandemic is likely to result in a large reallocation of employees. In this context, it is worth mentioning the study of [Karlsson et al. \(2014\)](#), who researched the impact of the 1918 Spanish flu pandemic on the economic performance of Sweden. The authors emphasized that the pandemic led to a significant increase in the number of the poor, and negatively affected the return on capital, however there was no significant impact on the change in income (neither during nor after the pandemic). The article also provided examples of other studies on the topic; the authors found that pandemics could indeed increase the number of unemployed but were unlikely to have a direct impact on the level of wages. Therefore, a hypothesis can be made that a pandemic can contribute to an increase in unemployment; nevertheless, a deeper analysis should be carried out to understand the relationship between changes in the level of wages in Russia and the coronavirus pandemic.

Further, the issue of economic recovery after the pandemic needs to be considered. [Tisdell \(2020\)](#) emphasized that the economic recovery from the pandemic will be slow, since in the modern world there is a high degree of interdependence between industries and countries. [Douglass \(2020\)](#) adds that in order to accelerate economic recovery after the pandemic, it will be necessary to make higher education programs more accessible to the general public, since higher education plays a key role in promoting socioeconomic mobility, innovation, and economic recovery. [Anser et al. \(2020\)](#) emphasized that prompt measures to regulate the economic and epidemiological situation are critically needed to minimize the consequences of the pandemic on a global level, since infectious diseases increase the number of the poor and slow down economic development, while an increase in health care costs contributes to economic development presented in a U-shaped relationship between economic growth and poverty reduction. In this regard, the opinion of [Laing \(2020\)](#) is interesting to consider. The researcher argues that, on the one hand, the economy can quickly recover, given that not a single production potential has been completely destroyed, as was in the case of economic collapses after the wars. On the other hand, periods of isolation can proceed to happen systematically over several months or years, which in the medium term will create a likely oversupply in some markets that will have to close or continue to work with low profit or loss.

All in all, within the analyzed theoretical and methodological basis, there is a consensus among scholars that the pandemic will affect many areas of society, nevertheless, it will become an impetus for the improvement and development of technologies, the emergence of innovative projects and systems. The labor market will change, there will be a redistribution of employees by industry, some industries will become less in demand. There will be an increase in the role of the Internet environment in society, which will contribute to the growth of remote work, the provision of educational services online, as well as affect the psychological state of people.

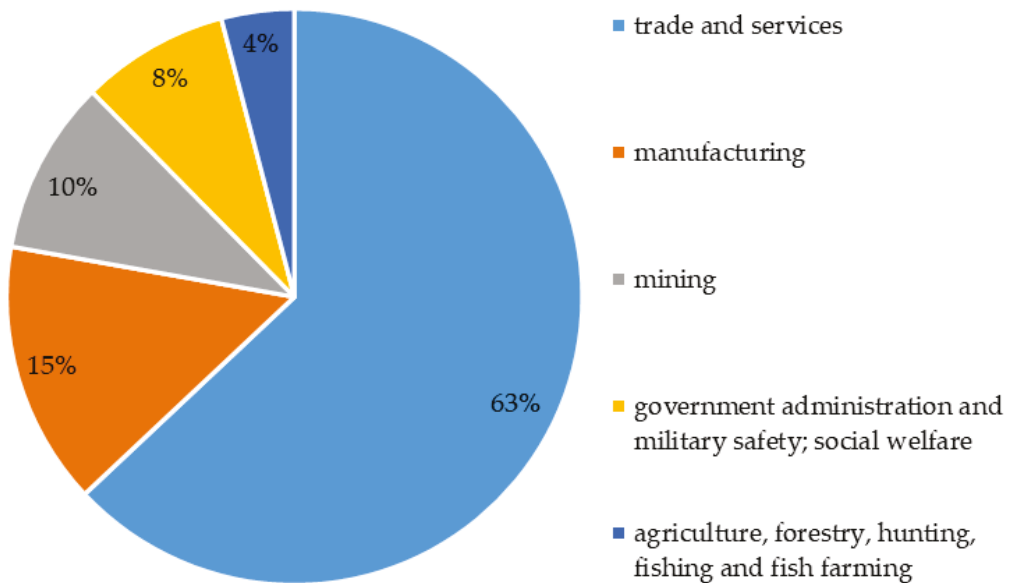
The aim of the current study is to investigate the impact of the new coronavirus infection on the Russian labor market. The distinctiveness of this study is the differentiation of the impact of the physical and informational spread of COVID-19 on the labor market in Russia, since in the age of widespread development of technologies and the importance of the information component of society cannot be ignored. Thus, one of the tasks of this study is to identify the influence of the information field on the set of elements that characterize the labor market of the Russian Federation. The informational spread of coronavirus will be measured through the dynamics of news messages related to the topic of “coronavirus”. Therefore, the study of the dynamics of related search queries in Yandex (Russian biggest search engine), an analysis of the average level of wages by type of economic activity, as well as the demand of employers and the number of vacancies, will be able to give a clearer picture of the state of the economy during the outbreak of coronavirus pandemic



in Russia, in order to reflect the general wellbeing of the country's inhabitants as well as the logic of the behavior of the population in conditions of COVID-19 pandemic. This will subsequently help to shape the answer to the question of what to do to minimize the negative consequences of COVID-19 on the Russian labor market.

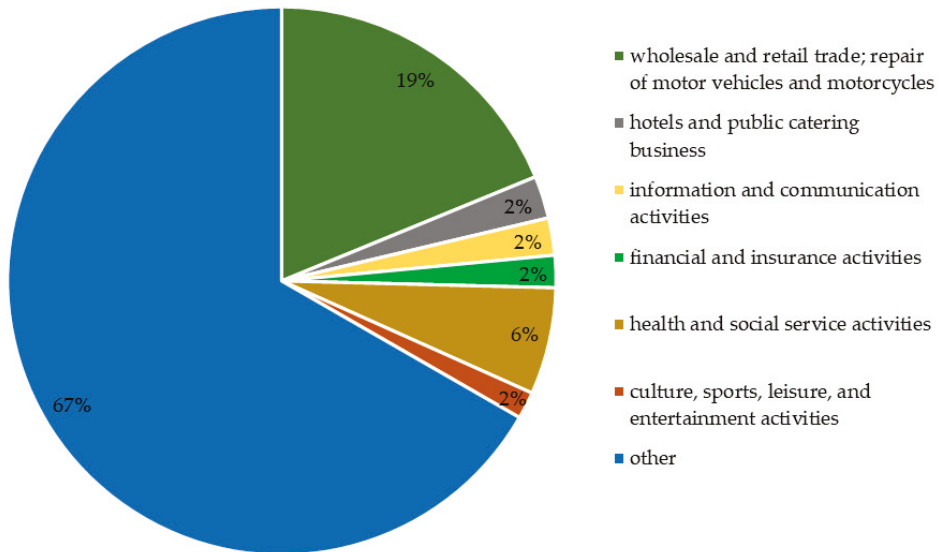
Regarding the rationale of the economy branches being taken into consideration within the framework of the study, it is necessary to highlight the investigation carried out by the *HeadHunter* Research Center—the largest online recruitment platform in the Russian Federation—on the most and least affected sectors of Russian economics because of the coronavirus pandemic. The research revealed that the service sector (including trading) was affected most, while such traditional sectors of the Russian economy, such as agriculture, mining, and industry, were listed as the least affected ones. The reason the service sector (including trading) was affected most is the specificity of B2C business model—because of “self-isolation” restrictions established by the government, businesses were physically incapable of selling goods and services to the customers.

The significance of the study is determined by the high share of the studied sector in the total GDP of Russia. According to Russian Federal State Statistics, the selected sector makes up more than half of the GDP of the Russian economy (see Figure 1), and in addition, more than a third of the able-bodied population of the Russian economy is employed in service sector branches taken into consideration within the framework of the study (see Figure 2).



**Figure 1.** Share of sectors in the GDP of Russia.

The research methodology proposed within the paper can be universally applicable to the vast majority of sectors of the economy. However, it focusses on the specifics of the COVID-19 pandemic, and to a greater extent the impact the service sector, the reasons for which were indicated above. In this regard, the authors decided to apply the proposed methodology specifically to the service sector in order to obtain the most significant results and draw the most unambiguous applied conclusions.



**Figure 2.** Share of the average annual numbers employed in the branches of the Russian economy (highlighting the role of the service sector).

The study itself is divided into five interrelated parts. Section 1, where the problem of the COVID-19 impact on the labor market is defined, the theoretical basis is investigated, and the investigation goals are set; Section 2, where the primary data and conceptual research model are presented and the research methodology is defined; Section 3, which includes confirmed conceptual model and systematic conclusions on the influence of factors on the set of selected indicators; Section 4, where, based on the data obtained, the hypothesized theories are taken into deeper consideration; and, finally, Section 5, where the impact of the physical and informational spread of the COVID-19 on the labor market is revealed and the recommendations for their management are given.

## 2. Materials and Methods

Before forming the conceptual model, relevant statistical data was collected. These are the data sources used for the purposes of the study:

1. *Yandex DataLens*—a service for data aggregation and analytics for identifying a number of COVID-19 cases per month in Russia;
2. The official newsgroup of RBC (*RosBusinessConsulting*)—the largest non-state media holding and a leading company working in the field of mass media and information technologies providing the latest news, the main topics of the day in politics, economics, business, and life—in *Vkontakte*, one of the most popular Russian social media, for identifying a frequency of mentioning the topic “coronavirus”;
3. *Russian Federal State Statistics Service*—the governmental statistics service that collects official statistical information on social, economic, demographic, environmental and other social processes taking place in the Russian Federation for measuring the dynamics of macroeconomic indicators;
4. *Yandex Wordstat*—a service that helps to aggregate information on Yandex users’ requests daily, weekly, monthly, etc., for measuring the dynamics of the search queries on the Yandex search engine.

The summary statistics are presented in Tables 1 and 2. We use some abbreviations for measures in the study: “pax” is for persons; “pcs” is for pieces; “ths. Pax” is for thousand persons; “rub”. is for rubles.

Table 1. Summary statistics.

Indicator	Period							
	January	February	March	April	May	June	July	August
The number of COVID-19 cases per month in Russia, pax.	0	0	2337	104,161	299,345	242,006	192,132	155,338
Frequency of mentioning the topic "coronavirus" in the RBC ( <i>RosBusinessConsulting</i> ) news group in Vkontakte social network, pcs	81	189	702	639	629	402	332	226
The number of officially registered unemployed age 15 and over, ths. pax.	839	869	855	1834	2543	3152	3637	3953
Total number of unemployed age 15 and over, ths. pax.	3482	3425	3485	4286	4513	4606	4731	4808
Average monthly nominal gross wages of employees by type of economic activity:								
- wholesale and retail trade; repair of motor vehicles and motorcycles, rub.;	40,685	40,940	46,359	42,335	39,136	42,302	41,258	39,928
- hotels and public catering business, rub.;	30,047	28,986	27,964	23,243	23,409	24,897	25,483	25,252
- information and communication activities, rub.;	76,215	78,949	87,942	92,422	81,754	82,354	83,716	80,209
- financial and insurance activities, rub.;	87,471	110,167	122,066	117,345	105,078	98,060	107,286	97,207
- health and social service activities, rub.;	44,565	43,246	44,957	42,355	53,147	53,740	52,501	49,567
- culture, sports, leisure, and entertainment activities, rub.	46,737	46,225	50,512	42,702	45,308	45,823	42,753	43,997
Dynamics of the employers' demand for employees, declared to the bodies of the employment service, pax.	1,464,000	1,496,000	1,493,000	1,346,000	1,385,000	1,518,000	1,639,000	1,692,000
Workload of unemployed population per 100 announced vacancies, pax *	57.3	58.1	57.3	136.2	183.7	207.6	221.9	233.6
Dynamics of the search queries on the <i>Yandex</i> search engine "удаленная работа" (remote work).	312,209	286,713	546,777	774,219	444,288	351,269	321,044	304,241

\* Workload of unemployed population per 100 announced vacancies, pax, or *load coefficient* shows the number of unemployed citizens registered with the employment service per 100 vacancies announced by employers to the employment service. When this coefficient is more than 100, it means that the number of officially unemployed people exceeds the number of official vacancies from employers.

Table 2. Dynamics of the search queries on the Yandex search engine weekly, pcs.

Indicator	Period	"удаленная работа" (Remote Work)	"пособие по безработице" (Unemployment Benefit)	"закрыть бизнес" (Close a Business)	"открыть бизнес" (Open a Business)	"самозанятость" (Self-Employment)	"онлайн-курсы" (Online Courses)
30 December 2019–05 January 2020		38,867	73,440	468	19,622	14,482	9837
6 January 2020–12 January 2020		66,895	117,298	656	30,606	22,516	19,873
13 January 2020–19 January 2020		80,054	150,339	938	28,627	29,761	35,569
20 January 2020–26 January 2020		75,069	125,755	968	28,278	33,872	33,377
27 January 2020–02 February 2020		72,118	151,968	917	26,506	28,676	29,931
3 February 2020–9 February 2020		72,560	160,086	937	27,339	26,413	27,288
10 February 2020–16 February 2020		69,379	143,053	898	26,783	25,119	25,251
17 February 2020–23 February 2020		64,352	122,176	872	25,452	23,030	25,038
24 February 2020–01 March 2020		73,513	210,073	910	24,484	22,322	22,322
2 March 2020–8 March 2020		58,522	231,315	832	21,760	22,086	21,553
9 March 2020–15 March 2020		71,987	735,978	991	24,092	22,568	22,134
16 March 2020–22 March 2020		164,389	736,750	2088	20,977	21,630	28,199
23 March 2020–29 March 2020		178,123	513,297	4695	18,288	19,110	164,692
30 March 2020–05 April 2020		194,204	470,800	2597	15,739	21,262	404,015
6 April 2020–12 April 2020		160,449	369,894	1707	18,987	23,496	475,446
13 April 2020–19 April 2020		144,252	323,867	1433	18,855	26,173	431,281
20 April 2020–26 April 2020		134,205	375,101	1411	19,569	26,444	408,051
27 April 2020–03 May 2020		106,832	274,514	1177	18,599	23,225	289,428
4 May 2020–10 May 2020		93,454	224,172	1025	18,140	18,653	210,853
11 May 2020–17 May 2020		107,140	211,569	1235	21,283	33,575	263,145
18 May 2020–24 May 2020		106,719	226,780	1191	23,786	27,829	223,895
25 May 2020–31 May 2020		104,191	195,686	1276	55,583	28,257	306,554
1 June 2020–7 June 2020		93,973	217,116	1366	121,517	28,856	307,206
8 June 2020–14 June 2020		72,591	179,959	1054	158,718	21,976	283,556
15 June 2020–21 June 2020		86,380	162,998	1088	140,123	24,046	257,111
22 June 2020–28 June 2020		72,365	147,916	996	110,502	42,783	235,343
29 June 2020–05 July 2020		71,299	198,422	847	88,384	43,036	203,203
6 July 2020–12 July 2020		74,055	178,117	751	72,759	31,454	186,269
13 July 2020–19 July 2020		73,250	148,497	838	64,612	28,420	155,406
20 July 2020–26 July 2020		74,063	155,396	786	56,712	27,910	143,893
27 July 2020–02 August 2020		68,803	208,083	848	49,895	27,751	154,048
3 August 2020–9 August 2020		67,822	207,415	954	47,452	27,125	150,110
10 August 2020–16 August 2020		70,007	166,346	2167	42,665	26,362	143,222
17 August 2020–23 August 2020		70,939	169,481	1520	40,188	26,149	134,322
24 August 2020–30 August 2020		70,015	199,135	1263	39,370	28,111	134,357

Based on the analysis of the theoretical and methodological basis, a conceptual research model was formed.

The components of the conceptual model are presented in Table 3.

**Table 3.** The summary array of indicators.

No.	Indicator	Designation	Measure	Type of Indicator	Source
1.	The number of COVID-19 cases per month in Russia.	$X_1$	pax	exogenous	Yandex DataLens Public (n.d.)
2.	The frequency of mentioning the topic “coronavirus” in the RBC ( <i>RosBusinessConsulting</i> ) news group in <i>Vkontakte</i> social network.	$X_2$	pcs	exogenous	Official News Group (n.d.)
3.	The number of officially registered unemployed age 15 and over.	$Y_1$	ths. pax	endogenous	Russian Federal State Statistics Service (n.d.)
4.	Total number of unemployed age 15 and over.	$Y_2$	ths. pax	endogenous	Russian Federal State Statistics Service (n.d.)
5.	Average monthly nominal gross wages of employees by type of economic activity:	$Y_3$			
5.1	<i>wholesale and retail trade; repair of motor vehicles and motorcycles;</i>	$Y_{3-1}$	rub.	endogenous	Russian Federal State Statistics Service (n.d.)
5.2	<i>hotels and public catering business;</i>	$Y_{3-2}$			
5.3	<i>information and communication activities;</i>	$Y_{3-3}$			
5.4	<i>financial and insurance activities;</i>	$Y_{3-4}$			
5.5	<i>health and social service activities;</i>	$Y_{3-5}$			
5.6	<i>culture, sports, leisure, and entertainment activities.</i>	$Y_{3-6}$			
6.	Dynamics of the employers’ demand for employees, declared to the bodies of the employment service.	$Y_4$	pax	endogenous	Russian Federal State Statistics Service (n.d.)
7.	The workload of the unemployed population per 100 announced vacancies.	$Y_5$	pax	endogenous	Russian Federal State Statistics Service (n.d.)
8.	Dynamics of the search queries on the <i>Yandex</i> search engine.				
8.1	“удаленная работа” (remote work).	$Y_{6-1}$		endogenous and exogenous	Yandex Wordstat (n.d.)
8.2	“пособие по безработице” (unemployment benefit).	$Y_{6-2}$	pcs	endogenous	
8.3	“закреть бизнес” (close a business).	$Y_{6-3}$		endogenous	
8.4	“открыть бизнес” (open a business).	$Y_{6-4}$		endogenous	
8.5	“самозанятость” (self-employment).	$Y_{6-5}$		endogenous	
8.6	“онлайн-курсы” (online courses).	$Y_{6-6}$		endogenous	

The relationship between the selected indicators is visualized in Figure 3.

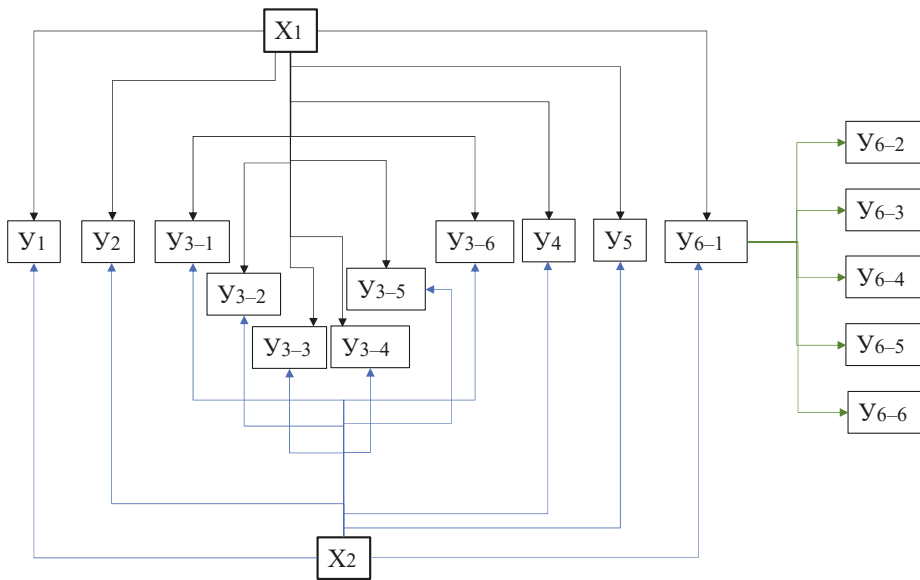


Figure 3. Conceptual research model.

The centroids of the conceptual model are factors  $X_1$ —the physical spread of coronavirus and  $X_2$ —the informational spread of coronavirus in Russia from January to August 2020. The initial conceptual model hypothesizes an increase in the number of unemployed under the influence of the physical and informational forms of coronavirus spread, a decrease in average wages in the studied range of economic activities, an increase in supply in the labor market, and a decrease in employers' demand for employees. It is also hypothesized that the physical and informational forms of coronavirus spread have a positive effect on the number of "remote work" searches on the Yandex search engine. Summarizing, using regression modeling, the logic of the behavior of the Russian society during the pandemic is indirectly investigated. The data obtained is mainly descriptive.

It should be noted that within the framework of the study the temporary array of statistical data is divided into three stages, corresponding to the stages of coronavirus spread in Russia from January to August 2020: the first stage is the growth of infection distribution and the absence of any governmental measures to prevent the further spread; the second stage is the peak of distribution, accompanied by severe governmental restrictions—a period of "self-isolation" for citizens, which obliged people not to leave their homes without any crucial reasons, compulsory closure of trade and service enterprises except for those selling living essentials; the third stage is the decline in the spread of COVID-19 and the mitigation of substantial part of the governmental restrictions for citizens and businesses. Statistical data for  $X_1$  and  $X_2$ , as well as  $Y_1, Y_2, \dots, Y_6$  is given by month from January to August 2020. The study allows us to draw conclusions about the extent to which the Russian economy, the labor market, and society were prepared for the changes caused by the coronavirus pandemic.

As one of the basic tasks of the study is to analyze the impact of the informational spread of coronavirus on  $Y_1, Y_2, \dots, Y_6$ , which characterize the Russian labor market from January to August 2020, the frequency of the appearance of news messages related to the topic of "coronavirus" in the RBC *Vkontakte* newsgroup was used as an indicator of the informational spread of coronavirus from January to August 2020. To conduct the study, an automated algorithm for collecting posts from the RBC *Vkontakte* group was built. Let us consider the stages of this algorithm (Rodionov et al. 2020):

1. Formation of the primary data set. Within the framework of this stage, the news array is collected in accordance with the analyzed period. The source of primary information is the largest Russian social media *Vkontakte*, namely the newsgroup of *RBC (RosBusinessConsulting)*, the largest non-state media holding and a leading company working in the field of mass media and information technologies providing the latest news, the main topics of the day in politics, economics, business, and life. Analysis of the news in this group makes it possible to understand the most relevant information messages during the spread of coronavirus in Russia. For automated parsing of information, Python 3 programming language was used. The result of this stage was eight tables containing the main news messages within the given months. To facilitate further analysis, tokens (meaningful units of text) were extracted from the news background by month. As part of the study, tokens that can give an idea of the information distribution of coronavirus in Russia were allocated.
2. Tokenization of the primary data set. To determine the dynamics of the information distribution of coronavirus in Russia, the received array of primary data was tokenized. The result of this stage is a table containing the number of tokens related to the topic “coronavirus” by month. The presence of the following tokens in the primary data set was investigated: “коронавирус” (coronavirus), “пандем” (pandem), “COVID”.

The research methodology is based on the traditional regression analysis, which implies the following defining criteria:

- The presence of structural breaks/structural outliers;
- Significance of Fisher’s F-test;
- P-level;
- Approximation error of the model;
- Multiple coefficient of determination  $R^2$ ;
- Heteroscedasticity of residues;
- The presence of multicollinearity;
- Analysis of the relative coefficients of elasticity.

A potential system of regression equations would look like the following:

Potential multiple regression equations:

$$\left\{ \begin{array}{l} Y_1 = a + b_1X_1 + b_2X_2 \\ Y_2 = a + b_1X_1 + b_2X_2 \\ Y_{3-1} = a + b_1X_1 + b_2X_2 \\ Y_{3-2} = a + b_1X_1 + b_2X_2 \\ Y_{3-3} = a + b_1X_1 + b_2X_2 \\ Y_{3-4} = a + b_1X_1 + b_2X_2 \\ Y_{3-5} = a + b_1X_1 + b_2X_2 \\ Y_{3-6} = a + b_1X_1 + b_2X_2 \\ Y_4 = a + b_1X_1 + b_2X_2 \\ Y_5 = a + b_1X_1 + b_2X_2 \\ Y_{6-1} = a + b_1X_1 + b_2X_2 \end{array} \right.$$

Potential paired regression equations:

$$\left\{ \begin{array}{l} Y_{6-2} = aY_{6-1}^b \\ Y_{6-3} = aY_{6-1}^b \\ Y_{6-5} = aY_{6-1}^b \\ Y_{6-6} = aY_{6-1}^b \end{array} \right.$$

To identify the impact of the physical and informational spread of coronavirus on the dynamics of indicators characterizing the labor market in Russia, we used multiple regression analysis. In this study, the confidence limit (reliability level) of the model was taken as 90%, and the permissible P-level was 10%, respectively. The chosen significance level of 10% is because the macromodel is being investigated, therefore,  $Y_1, Y_2 \dots Y_6$  are determined not only by  $X_1$  and  $X_2$ , but also by many other factors that are not included in the described model. Thus, every time the P-level of any  $Y$  exceeds the acceptable level of 10%, the multiple regression model is being optimized.

To study changes in the numbers of search queries, such as “unemployment benefit”, “close a business”, “open a business”, “self-employment”, and “online courses” regarding the numbers of search query “remote work”, we used paired regression tools to reveal the logic of people behavior during the pandemic. The array of analyzed data has been

expanded to include primary data by week, from January to August 2020. As part of the paired regression analysis, the confidence limit (reliability level) of the model was increased to 95% due to the growth of the primary data set. The methodology of the study includes the assumed square cube connection in the description of the system of equations.

### 3. Results

In accordance with the above methodology, the influence of factors on the set of elements that characterize the Russian labor market from January to August 2020 was tested. Figure 4 shows the validated conceptual model. This model allows to visualize how strongly the factors affect the studied variables.

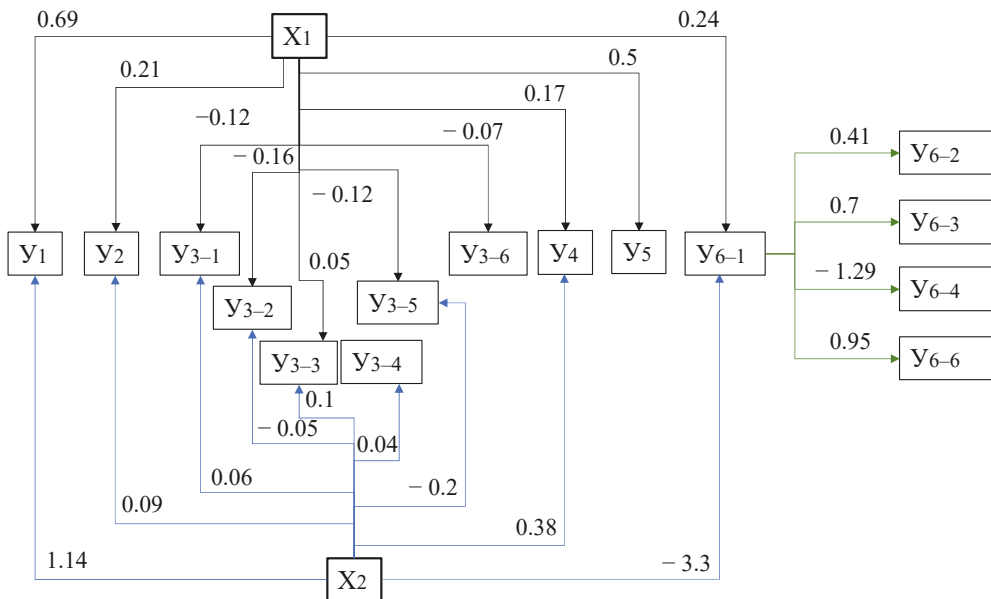


Figure 4. Validated conceptual model.

The validated conceptual model is described by the following system of multiple and paired regression equations (see Table 4). In Table 4 \*\*, \* indicate significance at 10% and 5%, respectively.

Based on the analysis of the relative coefficients of elasticity, the following interpretation of the main empirical findings, presented in Table 4, can be given.

*Multiple regression.*  $X_1$  and  $X_2$  increased the values of  $Y_1$ , i.e., the physical and informational spread of the coronavirus increased the number of officially registered unemployed aged 15 and over. When the physical spread of the coronavirus  $X_1$  changed by 1%, the number of officially registered unemployed aged 15 and over increased from 0.56 to 0.82%; when the informational spread changed by 1%, the indicator increased from 0.51 to 1.77%.

$X_1$  and  $X_2$  increased the values of  $Y_2$ , i.e., the physical and informational spread of the coronavirus increased the total number of unemployed aged 15 and over. When the physical spread changed by 1%, the total number of unemployed aged 15 and over increased from 0.21 to 0.22%; when information spread of the coronavirus changed by 1%, the total number of unemployed aged 15 and over increased from 0.06 to 0.11%.



Table 4. System of multiple and paired regression equations to describe the validated conceptual model.

Multiple Regression									
Equation	The Presence of Structural Breaks/Structural Outliers	Significance of Fisher's F-Test	P-Level (for F-Test)	Approximation Error of the Model	Multiple Coefficient of Determination R <sup>2</sup>	The Statistical Significance for Each Coefficient	The Presence of Multi-collinearity	Analysis of the Relative Coefficients of Elasticity	
Y <sub>1</sub> = -246.8 + 0.02 * X <sub>1</sub> + 19.01 * X <sub>2</sub> - 1.5 * 10 <sup>-13</sup> * X <sub>3</sub> <sup>3</sup> - 0.08 * X <sub>2</sub> <sup>2</sup> + 0.00008 * X <sub>3</sub> <sup>2</sup>	No structural breaks, structural outliers are extremely insignificant	0.007	<0.1	5.8%	99.7%	X <sub>1</sub> *** X <sub>2</sub> ** X <sub>3</sub> *** X <sub>2</sub> <sup>2</sup> ** X <sub>3</sub> <sup>2</sup> **	No multi-collinearity between X <sub>1</sub> and X <sub>2</sub> is observed	When X <sub>1</sub> changes by 1%, Y <sub>1</sub> increases from 0.56% to 0.82%. When X <sub>2</sub> changes by 1%, Y <sub>1</sub> increases from 0.51% to 1.77%.	
Y <sub>2</sub> = 3345.74 + 0.01 * X <sub>1</sub> + 2.8 * X <sub>2</sub> - 3.2 * 10 <sup>-8</sup> * X <sub>2</sub> <sup>2</sup> - 0.016 * X <sub>2</sub> <sup>3</sup> + 0.00002 * X <sub>3</sub> <sup>3</sup>	Absence of structural breaks and structural outliers	0.0002	<0.1	0.2%	99.9%	X <sub>1</sub> *** X <sub>2</sub> *** X <sub>2</sub> <sup>2</sup> *** X <sub>2</sub> <sup>3</sup> *** X <sub>3</sub> <sup>3</sup> ***	No multi-collinearity between X <sub>1</sub> and X <sub>2</sub> is observed	When X <sub>1</sub> changes by 1%, Y <sub>2</sub> increases from 0.21% to 0.22%. When X <sub>2</sub> changes by 1%, Y <sub>2</sub> increases from 0.06% to 0.11%.	
Y <sub>3-1</sub> = 40551.36 - 0.1 * X <sub>1</sub> + 0.000001 * X <sub>2</sub> <sup>2</sup> - 2.75 * 10 <sup>-12</sup> * X <sub>3</sub> <sup>3</sup> + 0.01 * X <sub>2</sub> <sup>2</sup>	No structural breaks, structural outliers are extremely insignificant	0.003	<0.1	1%	98.9%	X <sub>1</sub> *** X <sub>2</sub> <sup>2</sup> *** X <sub>3</sub> <sup>3</sup> *** X <sub>2</sub> <sup>2</sup> ***	No multi-collinearity between X <sub>1</sub> and X <sub>2</sub> is observed	When X <sub>1</sub> changes by 1%, Y <sub>3-1</sub> decreases from -0.9% to -0.15%. When X <sub>2</sub> changes by 1%, Y <sub>3-1</sub> increases from 0.05% to 0.07%.	
Y <sub>3-2</sub> = 30026.7 - 0.09 * X <sub>1</sub> - 2.9 * X <sub>2</sub> + 6.43 * 10 <sup>-7</sup> * X <sub>1</sub> <sup>2</sup> - 1.24 * 10 <sup>-12</sup> * X <sub>1</sub> <sup>3</sup>	Absence of structural breaks and structural outliers	0.005	<0.1	2%	98.4%	X <sub>1</sub> ** X <sub>2</sub> * X <sub>2</sub> <sup>2</sup> ** X <sub>1</sub> <sup>2</sup> ** X <sub>1</sub> <sup>3</sup> **	No multi-collinearity between X <sub>1</sub> and X <sub>2</sub> is observed	When X <sub>1</sub> changes by 1%, Y <sub>3-2</sub> decreases from -0.09% to -0.22%. When X <sub>2</sub> changes by 1%, Y <sub>3-2</sub> decreases from -0.01% to -0.08%.	
Y <sub>3-3</sub> = 74295.5 + 0.06 * X <sub>1</sub> + 20.9 * X <sub>2</sub> - 2.67 * 10 <sup>-7</sup> * X <sub>2</sub> <sup>2</sup>	Absence of structural breaks and structural outliers	0.003	<0.1	2%	95.9%	X <sub>1</sub> ** X <sub>2</sub> *** X <sub>1</sub> <sup>2</sup> ***	No multi-collinearity between X <sub>1</sub> and X <sub>2</sub> is observed	When X <sub>1</sub> changes by 1%, Y <sub>3-3</sub> increases from 0.02% to 0.07%. When X <sub>2</sub> changes by 1%, Y <sub>3-3</sub> increases from 0.08% to 0.12%.	

Table 4. Cont.

Multiple Regression								
Equation	The Presence of Structural Breaks/Structural Outliers	Significance of Fisher's F-Test	P-Level (for F-Test)	Approximation Error of the Model	Multiple Coefficient of Determination R <sup>2</sup>	The Statistical Significance for Each Coefficient	The Presence of Multi-collinearity	Analysis of the Relative Coefficients of Elasticity
Y <sub>3-4</sub> = 96651.58 + 0.043 * X <sub>2</sub> <sup>1/2</sup>	Insignificant structural breaks. Structural outlier in February.	0.03	<0.1	8%	54.7%	X <sub>2</sub> <sup>**</sup>	-	When X <sub>2</sub> changes by 1%, Y <sub>3-4</sub> changes from -0.003% to -0.089%
Y <sub>3-5</sub> = 45471.8 - 0.14 * X <sub>1</sub> + 1.9 * 10 <sup>-6</sup> * X <sub>2</sub> <sup>1/2</sup> - 4.33 * 10 <sup>-12</sup> * X <sub>3</sub> <sup>3</sup> - 0.09 * X <sub>2</sub> <sup>2</sup> + 0.00013X <sub>2</sub> <sup>3</sup>	Absence of structural breaks and structural outliers	0.01	<0.1	1%	99.4%	X <sub>1</sub> <sup>**</sup> X <sub>2</sub> <sup>**</sup> X <sub>3</sub> <sup>**</sup> X <sub>2</sub> <sup>2</sup> * X <sub>2</sub> <sup>3</sup> *	No multi-collinearity between X <sub>1</sub> and X <sub>2</sub> is observed	When X <sub>1</sub> changes by 1%, Y <sub>3-5</sub> decreases from -0.06% to -0.19%. When X <sub>2</sub> changes by 1%, Y <sub>3-5</sub> decreases from -0.03% to -0.38%.
Y <sub>3-6</sub> = 47716.8 - 0.05 * X <sub>1</sub> + 1.58 * 10 <sup>-6</sup> * X <sub>2</sub> <sup>1/2</sup>	Insignificant structural breaks. Structural outlier in March.	0.09	<0.1	4%	61.5%	X <sub>1</sub> <sup>**</sup> X <sub>1</sub> <sup>*</sup>	-	When X <sub>1</sub> changes by 1%, Y <sub>3-6</sub> decreases from -0.02% to -0.13%
Y <sub>4</sub> = 1214415.4 + 4263.5 * X <sub>2</sub> + 1.87 * 10 <sup>-5</sup> * X <sub>2</sub> <sup>2</sup> - 5.45 * 10 <sup>-11</sup> * X <sub>3</sub> <sup>3</sup> - 17.7 * X <sub>2</sub> <sup>2</sup> + 0.017 * X <sub>2</sub> <sup>3</sup>	No structural breaks, structural outliers are extremely insignificant	0.07	<0.1	2%	97%	X <sub>2</sub> <sup>*</sup> X <sub>1</sub> <sup>*</sup> X <sub>3</sub> <sup>*</sup> X <sub>2</sub> <sup>2</sup> ** X <sub>2</sub> <sup>3</sup> **	No multi-collinearity between X <sub>1</sub> and X <sub>2</sub> is observed	When X <sub>1</sub> changes by 1%, Y <sub>4</sub> increases from 0.04% to 0.3%. When X <sub>2</sub> changes by 1%, Y <sub>4</sub> increases from 0.1% to 0.65%.
Y <sub>5</sub> = 54.5 + 0.0012 * X <sub>1</sub> - 8.22 * 10 <sup>-15</sup> * X <sub>2</sub> <sup>1/2</sup>	Absence of structural breaks and structural outliers	0.0004	<0.1	14%	95.4%	X <sub>1</sub> <sup>***</sup> X <sub>1</sub> <sup>***</sup>	-	When X <sub>1</sub> changes by 1%, Y <sub>5</sub> increases from 0.38% to 0.62%
Y <sub>6-1</sub> = 1347493.78 + 1.71 * X <sub>1</sub> - 10367.4 * X <sub>2</sub> - 8.57 * 10 <sup>-6</sup> * X <sub>2</sub> <sup>1/2</sup> + 0.71 * X <sub>3</sub> <sup>3</sup> + 29.6 * X <sub>2</sub> <sup>2</sup> - 0.7 * X <sub>2</sub> <sup>3</sup>	Absence of structural breaks and structural outliers	0.002	<0.1	0.15%	99.9%	X <sub>1</sub> <sup>***</sup> X <sub>2</sub> <sup>***</sup> X <sub>3</sub> <sup>***</sup> X <sub>3</sub> <sup>3</sup> *** X <sub>2</sub> <sup>1</sup> *** X <sub>2</sub> <sup>2</sup> *** X <sub>2</sub> <sup>3</sup> ***	No multi-collinearity between X <sub>1</sub> and X <sub>2</sub> is observed	When X <sub>1</sub> changes by 1%, Y <sub>6-1</sub> increases from 0.23% to 0.25%. When X <sub>2</sub> changes by 1%, Y <sub>6-1</sub> decreases from -3.21% to -3.39%.

Table 4. Cont.

Multiple Regression									
Equation	The Presence of Structural Breaks/Structural Outliers	Significance of Fisher's F-Test	P-Level (for F-Test)	Approximation Error of the Model	Multiple Coefficient of Determination R <sup>2</sup>	The Statistical Significance for Each Coefficient	The Presence of Multi-collinearity	Analysis of the Relative Coefficients of Elasticity	
<b>Paired regression</b>									
$Y_{6-2} = 1.045 * Y_{6-1}^{1.075}$	Insignificant structural breaks. Structural outlier in March.	<0.05	<0.05	2.7%	57%	$Y_{6-1}^{***}$	-	When $Y_{6-1}$ changes by 1%, $Y_{6-2}$ increases from 0.35% to 0.47%	
$Y_{6-3} = 0.0215 * Y_{6-1}^{0.9572}$	Insignificant structural breaks. Structural outlier in the end of March.	<0.05	<0.05	3.6%	63.6%	$Y_{6-1}^{***}$	-	When $Y_{6-1}$ changes by 1%, $Y_{6-3}$ increases from 61% to 79%	
$Y_{6-4} = 5 * 10^7 * Y_{6-1}^{-0.631}$	Insignificant structural breaks. Structural outlier in June.	<0.05	<0.05	5.9%	11.6%	$Y_{6-1}^{**}$	-	When $Y_{6-1}$ changes by 1%, $Y_{6-4}$ decreases from -0.68% to -1.9%	
<b>No connection between <math>Y_{6-5}</math> и <math>Y_{6-1}</math> (P-level &gt; 0.05)</b>									
$Y_{6-6} = 0.0001 * Y_{6-1}^{1.8131}$	Insignificant structural breaks. Structural outliers in March and June.	<0.05	<0.05	8.24%	30.9%	$Y_{6-1}^{***}$	-	When $Y_{6-1}$ changes by 1%, $Y_{6-6}$ increases from 0.7% to 1.2%	

\*\*\*, \*\*, and \* indicate statistical significance at the 1%, 5%, and 10% levels, respectively. Potential heteroskedasticity is observed in all equations. Heteroskedasticity and autocorrelation consistent standard errors were used to provide an estimate of the covariance matrix of the parameters of a regression-type models (Paz 2022).

$X_1$  and  $X_2$  had a multidirectional effect on  $Y_{3-1}$ , i.e., the physical spread of the coronavirus decreased the average monthly nominal gross wages of employees in wholesale and retail trade, repair of motor vehicles, and motorcycles; while the informational spread of the coronavirus increased the indicator. When the physical spread changed by 1%, the average monthly nominal gross wages decreased from  $-0.9$  to  $-0.15\%$ ; when the informational spread of the coronavirus changed by 1%, the indicator increased from  $0.05\%$  to  $0.07\%$ .

$X_1$  and  $X_2$  decreased the values of  $Y_{3-2}$ , i.e., the physical and informational spread of the coronavirus decreased the average monthly nominal gross wages of employees in hotels and public catering businesses. When the physical spread changed by 1%, the average monthly nominal gross wages of employees in hotels and public catering businesses decreased from  $-0.09$  to  $-0.22\%$ ; when the informational spread of the coronavirus changed by 1%, the indicator decreased from  $-0.01$  to  $-0.08\%$ .

$X_1$  and  $X_2$  increased the values of  $Y_{3-3}$ , i.e., the physical and informational spread of the coronavirus increased the average monthly nominal gross wages of employees in information and communication activities. When the physical spread of coronavirus  $X_1$  changed by 1%, the average monthly nominal gross wages of employees in information and communication activities increased from  $0.02$  to  $0.07\%$ ; when the informational spread of the coronavirus changed by 1%, the indicator increased from  $0.08$  to  $0.12\%$ .

$X_2$  increased the values of  $Y_{3-4}$ , i.e., when the information spread of the coronavirus changed by 1%, the average monthly nominal gross wages of employees in financial and insurance activities increased from  $-0.003$  to  $0.089\%$ .

$X_1$  and  $X_2$  decreased the values of  $Y_{3-5}$ , i.e., the physical and informational spread of the coronavirus decreased the average monthly nominal gross wages of employees in health and social service activities. When the physical spread of coronavirus  $X_1$  changed by 1%, the average monthly nominal gross wages of employees in health and social service activities decreased from  $-0.06$  to  $-0.19\%$ ; when the information spread,  $X_2$  changed by 1%, the indicator decreased from  $-0.03$  to  $-0.38\%$ .

$X_1$  decreased the values of  $Y_{3-6}$ , i.e., when the physical spread of the coronavirus changed by 1%, the average monthly nominal gross wages of employees in culture, sports, leisure, and entertainment activities decreased from  $-0.02$  to  $-0.13\%$ .

$X_1$  and  $X_2$  increased the values of  $Y_4$ , i.e., the physical and informational spread of the coronavirus increased the employers' demand for employees, declared to the bodies of the employment service. When the physical spread of coronavirus  $X_1$  changed by 1%, the employers' need for employees, declared to the employment service bodies, increased from  $0.04$  to  $0.3\%$ ; when the informational spread changed by 1%, the indicator increased from  $0.1$  to  $0.65\%$ .

$X_1$  increased the values of  $Y_5$ , i.e., the physical spread of the coronavirus increased the workload of the unemployed population per 100 announced vacancies. When the physical spread of the coronavirus changed by 1%, the indicator increased from  $0.38$  to  $0.62\%$ .

$X_1$  and  $X_2$  had a multidirectional effect on  $Y_{6-1}$ , i.e., the physical spread of the coronavirus increased the number of search queries on the Yandex search engine "удаленная работа" (remote work), while the informational spread of coronavirus decreased the indicator. When the physical spread of the coronavirus changed by 1%, the number of search queries increased from  $0.23$  to  $0.25\%$ ; when the informational spread of the coronavirus changed by 1%, the indicator decreased from  $-3.21$  to  $-3.39\%$ .

*Paired regression.*  $Y_{6-1}$  increased the values of  $Y_{6-2}$ , i.e., search queries on the Yandex search engine "удаленная работа" (remote work) increased the number of search queries "пособие по безработице" (unemployment benefit). When search queries on the Yandex search engine "удаленная работа" (remote work) changed by 1%, search queries "пособие по безработице" (unemployment benefit) increased from  $0.35$  to  $0.47\%$ .

$Y_{6-1}$  increased the values of  $Y_{6-3}$ , i.e., search queries on the Yandex search engine "удаленная работа" (remote work) increased the number of search queries "закрыть бизнес" (close a business). When search queries on the Yandex search engine "удаленная

работа” (remote work) changed by 1%, the search queries “закрыть бизнес” (close a business) increased from 61 to 79%.

$Y_{6-1}$  decreased the values of  $Y_{6-4}$ , i.e., search queries on the Yandex search engine “удаленная работа” (remote work) decreased the number of search queries “открыть бизнес” (open a business). When search queries on the Yandex search engine “удаленная работа” (remote work) changed by 1%, the search queries “открыть бизнес” (open a business) decreased from  $-0.68$  to  $-1.9\%$ .

$Y_{6-1}$  increased the values of  $Y_{6-6}$ , i.e., search queries on the Yandex search engine “удаленная работа” (remote work) increased the number of search queries “онлайн-курсы” (online courses). When search queries on the Yandex search engine “удаленная работа” (remote work) changed by 1%, the search queries “онлайн-курсы” (online courses) increased from 0.7 to 1.2%.

Thus, the following systemic conclusions can be drawn:

1. The spread of the new coronavirus infection has indeed contributed to an increase in the unemployment rate in the Russian labor market (see equations  $Y_1$  and  $Y_2$ ).
2. The impact of the physical and informational spread of coronavirus on the dynamics of the average monthly nominal gross wages of employees by type of economic activity can be described as follows:
  - for the section “Wholesale and retail trade; repair of motor vehicles and motor-cycles” wages increased in the period January to February 2020, which may be primarily due to the fear that arose in the Internet environment in anticipation of the spread of a new infection, then fell from March to May 2020, after which it stabilized. Interestingly, the physical spread of coronavirus negatively affected the average wage level, while the informational spread did it in a positive way (see equation  $Y_{3-1}$ ).
  - for the section “Hotels and public catering business”, the average level of wages demonstrated a decrease from January to April 2020. Starting from May, the analyzed values gradually levelled out (see equation  $Y_{3-2}$ ).
  - for the section “Information and communication activities”, an increase in the average level of wages happened in the period from January to April 2020, since the physical and informational spread of coronavirus contributed to the intensification of activities related to the creation of content of various forms; in April to May the impact of coronavirus on the analyzer started to decline (see equation  $Y_{3-3}$ ).
  - for the section “Financial and insurance activities”, the model demonstrated an increase in average wages from January to March 2020. Further, from March to August, there was a negative dynamic in average wages. It is worth mentioning that in the process of optimization by the P-level criterion, the  $X_1$  indicator (physical spread of coronavirus) was completely excluded from this model, see equation  $Y_{3-4}$ .
  - the section “Health and social service activities” was characterized by an unstable change in the average level of wages from January to April 2020, however, since April, the average level of wages increased rapidly and reached its peak values in June 2020 (see equation  $Y_{3-5}$ ).
  - the section “Culture, sports, leisure, and entertainment activities” was characterized by negative impact of coronavirus spread on average wages, and in this case, we are talking only about the physical spread of coronavirus, since according to the P-level criterion, indicator  $X_2$  (informational spread of coronavirus) was completely excluded from the model, see equation  $Y_{3-6}$ .
3. There was a gradual decrease in the demand of employers for employees from January to April 2020. Further, the physical and informational spread of coronavirus, after reaching its peak values in April–May, begins to invariably increase the demand of employers for employees; and it is noteworthy that the informational spread of coronavirus had the greater impact on  $Y_4$  (see equation  $Y_4$ ).

4. With regard to the impact of coronavirus spread on the workload of unemployed population per 100 announced vacancies from January to August 2020, the analyzed indicator increased sharply since March 2020. Such dynamics speak about the increase in the number of citizens wishing to start working, and an increase in competition for every vacancy. In this model,  $X_2$  (informational spread of coronavirus) was completely excluded according to the P-level criterion, that is, the described dependence was a consequence of the physical spread of coronavirus only (see equation  $Y_5$ ).
5. The influence of the spread of coronavirus on the dynamics of search query “remote work” on the Yandex search engine from January to August 2020 was also proved. The increase in the number of search queries from February to April may be due to the physical spread of coronavirus in Russia and the lack of sufficient information about the new disease—people were afraid of its potential impact on the labor market, therefore, they were looking for ways to make money in the new reality. In general, it was found that the physical spread of coronavirus increased the number of related search queries on the Yandex search engine from January to August 2020, while informational spread of coronavirus, on the contrary, reduced the number of these search queries, and it was the latter that had the greatest impact on  $Y_{6-1}$ , see equation  $Y_{6-1}$ .
6. As for the dynamics of related search queries on the Yandex search engine, the following dependencies were identified:
  - analysis of the dynamics of the search query “unemployment benefit” demonstrated the presence of a structural outlier in March 2020, which is quite natural: it was in March that the first cases of COVID-19 infection were registered in Russia, and there was a massive closure of enterprises due to the introduction of severe restrictive measures, people literally remained without means of livelihood, therefore, they showed a particular interest in possible support from the state in the form of unemployment benefits. Overall, the change in the number of searches for “remote work” contributed to an increase in the number of searches for “unemployment benefit” in March 2020; starting from April, the number of searches for “unemployment benefit” gradually began to decline (see equation  $Y_{6-2}$ ).
  - analysis of the dynamics of the search query “close a business” on the Yandex search engine also demonstrated the presence of a structural outlier in March 2020: as mentioned earlier, in early March, the first cases of COVID-19 infection were registered in Russia, there was a consistent introduction of severe restrictive measures, and already at the end of the month, many enterprises were closed due to unprofitability and the impossibility of further functioning, thus, people began to especially actively search for relevant information on the Internet. The structural outlier was also observed in August 2020; this point can primarily be explained by the seasonal nature of some types of business (see equation  $Y_{6-3}$ ).
  - analysis of the dynamics of the search query “open a business” on the Yandex search engine shows the presence of a structural outlier in June 2020, which can also be explained by seasonal specifics, the beginning of the tourist season, as well as the gradual removal of some restrictions in Russia. However, the model shows a negative trend in the “open a business” search query over the analyzed period.  $Y_{6-1}$  has a negative impact on the dynamics of  $Y_{6-4}$ , meaning that the dynamics of the search query “remote work” invariably reduce the number of search queries “open a business” (see equation  $Y_{6-4}$ ).
  - analysis of the dynamics of the search query “self-employment” showed no connection with the dynamics of the search query “remote work”; this is the only model that has not been confirmed.
  - analysis of the dynamics of the search query “online courses” shows the presence of structural outliers in March and June 2020. The structural outlier in March may be associated with the tense situation in connection with the spread of COVID-19,

the anxiety of citizens was accompanied by a decrease in interest in online courses and an increase in interest in other types of information (in particular, the search for information on measures of support from the state during the pandemic). Structural outliers in June may be related to the onset of the holiday season (see equation  $Y_{6-6}$ ).

#### 4. Discussion

Based on the data obtained, it can be concluded that the presence of most of the hypothesized links was confirmed.

Thus, the impact of the physical and informational spread of coronavirus from January to August 2020 on the following elements of the Russian labor market was confirmed: number of officially registered unemployed; total number of unemployed; average monthly nominal gross wages by such types of economic activity as “Wholesale and retail trade, repair of motor vehicles and motorcycles”; “Hotels and public catering business”; “Information and communication activities”; “Health and social service activities”; dynamics of the employers’ demand for employees, declared to the bodies of the employment service; dynamics of the search query “remote work” on the Yandex search engine. As part of the paired regression analysis, the influence of the numbers of the search query “remote work” on the number of such search queries as “unemployment benefit”, “close a business”, “open a business”, and “online courses” was also confirmed.

However, several hypotheses have not been statistically confirmed. The study found that the physical spread of coronavirus did not affect the average monthly nominal wages for the type of economic activity “Financial and insurance activities”—this indicator is only influenced by the informational spread of coronavirus. The influence of the informational spread of coronavirus on the average monthly nominal gross wages for the type of economic activity “Culture, sports, leisure, and entertainment activities”, as well as on the workload of the unemployed population per 100 declared vacancies, also has not been confirmed—these indicators are only influenced by the physical spread of coronavirus. As part of the paired regression analysis, we had to refute the hypothesis that “remote work” searches influence “self-employment” searches. The assumption that the pandemic contributed to a decrease in employers’ demand for employees also has not been confirmed.

The analysis of the statistical dataset made it possible to clarify and supplement the theoretical basis of this study. Thus, the impact of the coronavirus pandemic in Russia on the growth of unemployment was confirmed. In the paper, the focus is set on the employees and the average rates of their wages. Since citizens and income are broader indicators, commenting on the statement that there is no direct effect of the pandemic on the average income of citizens would be incorrect. Nevertheless, the analysis established a clear relationship between the spread of coronavirus infection and changes in the average wages of employees. It should be especially noted the specificity of the influence of the informational and physical forms of coronavirus spread on the analyzed indicator. In most cases, the change in average wages was influenced by both forms of the spread of coronavirus infection, and only in two cases out of seven was it identified that the influence of only one form of coronavirus spread on the analyzed indicator.

In some cases, the multidirectional influence of the informational and physical forms of coronavirus spread on the average level of wages has been revealed. It can be concluded that there are blocks of professional activities that are more sensitive to impulses coming to the real world from the information world.

The assumptions that employees in the IT professions are less susceptible to the negative effects of epidemiological outbreaks have been partly confirmed. Nevertheless, it is impossible to say unequivocally that the pandemic led to a large redistribution of employees in the labor market in Russia: as part of the analysis of paired regressions, it was found that the majority of Russians quickly adapted to the changing conditions during a difficult epidemiological situation and continue to work in their specialization. The most

significant change was not a change in the field of professional activity, but a change in the form of employment: from freelance to hired labor.

Within the framework of the study, the block devoted to the study of the dynamics of changes in related search queries regarding the search query “remote work” should be highlighted. The study of these dependencies indirectly allowed to reveal the logic of the behavior of the Russian society during the spread of the new coronavirus infection. Of course, it cannot be said that the study of paired regressions fully describes the logic of people’s behavior during the pandemic (to establish such connections it is necessary to analyze a much larger array of search queries), nevertheless, it is possible to draw conclusions how much society was ready for the changes that took place, to what extent citizens were ready to change their behavior patterns in a crisis.

The dynamics of the numbers of the search query “remote work” had a 70% impact on the dynamics of the numbers of the search query “close a business”, which is the most significant indicator of elasticity coefficient in the framework of all validated regression equations. This means that most of the people who showed interest in working from home were most likely forced to stop their entrepreneurial activity, which means that they had to move from the model of working “for oneself” to the model of working “for someone else”; someone whose business has not been affected so greatly by the spread of the coronavirus infection and consistently imposed restrictions. It is noteworthy that the more people are interested in remote work, the less they show interest in starting their own business.

In addition, within the framework of paired regression, we analyzed the dynamics of changes in the search query “online courses” in relation to the query “remote work”. The coefficient of elasticity for this variable showed values of less than 1%. Thus, it can be assumed that the bulk of society interested in switching to remote work during the spread of the new coronavirus infection in Russia was generally satisfied with the area of professional activity that they had been engaged in before the onset of the pandemic. A smaller proportion of citizens nevertheless decided to master new skills necessary to continue working in the context of the “coronavirus” reality.

The elasticity coefficient for the search query “unemployment benefit” as part of testing the paired regression model showed the lowest values  $-0.41\%$ . Thus, people were less interested in support from the state in the context of remote employment. This logic of behavior can be explained by the fact that during the period of the spread of COVID-19 and the introduction of restrictive measures, there was an opinion in the Russian society that remote work was nothing more than a new form of employment and it is quite equivalent to the usual way of working, which means that can also provide an acceptable level of earnings.

Essentially, the conducted research confirms the idea that along with the objective world, there is also the information world, the significance of which cannot be ignored since it exerts its influence on the totality of processes and phenomena in the objective world. Moreover, as part of the study, it was found that the influence of the information environment, namely the informational spread of coronavirus, had an even greater impact than the physical spread.

As part of the analysis of multiple regressions, the “delay effect of physical consequences” was discovered. It means that the consequences of the informational spread of coronavirus, in some cases, brought a return to the transformation of the objective world earlier than the consequences of the physical spread of coronavirus.

Within the framework of the study, it should also be noted that the information environment does not always have an impact with the same directionality as the objective environment. In several cases, the inverse dependences of the informational and physical spread of coronavirus on the elements that characterize the labor market were revealed. This, among other things, can be explained by the mentioned “delay effect of physical consequences” phenomenon.



Thus, the physical spread of coronavirus has a direct impact on the elements of the labor market, and informational spread, in addition to direct impact, also has an indirect impact on the transformation of the external environment, as well as the behavior of society.

Thus, it seems logical to conclude that the information world has a transformational impact on the external environment, therefore, the physical and informational forms of the spread of coronavirus are related to each other, which is why a systematic management of these factors in order to minimize the negative impact of COVID-19 on the labor market in Russia is needed.

In the context of widespread informatization of society, ignoring fluctuations in the information environment is unreasonable because it is not only capable of influencing the processes of the objective world, but also can exert a much stronger influence than material factors. In this regard, the speed and the quality of information flow related to COVID-19 should be paid attention first. It is the quality of information related to the topic of coronavirus that can become a defining issue in minimizing negative impacts on the labor market, as well as the psychoemotional state of people. The more the Internet environment is saturated with “empty” information that does not give the user an objective assessment of the current situation, the faster the growth of uncontrolled, impulsive actions of the people will be. That firstly happened in the first quarter of 2020. The fear that struck the country during the onset of the pandemic contributed to the growth of social tension and confusion, which, in turn, impacted on the real processes and phenomena of the physical world (the economic state of the labor market in Russia).

## 5. Conclusions

The findings obtained lead to the conclusion that the coronavirus pandemic contributed to an increase in the number of unemployed and had a decisive impact on the change in average wages. It was also revealed that in the conditions of wide informatization of society, special attention should be paid to the information environment. The so-called “delay effect of physical consequences” was identified: the consequences of the informational spread of coronavirus, in some cases, brought a return to the transformation of the phenomena of the material world earlier than the consequences of the physical spread of coronavirus, which had an impact on the processes of the material world with a certain time delay. The study also established the rapid adaptation of Russian society to the new conditions of remote employment.

It is necessary to systematically influence the physical and informational spread of coronavirus in order to minimize the negative consequences of the pandemic on the labor market. Methods for the implementation of this impact can be conditional, in accordance with the basic division of distribution types into two categories—physical and informational. The physical methods should primarily include the strengthening of the predictive properties of the development of medical systems. This strengthening can be manifested in an increase in the frequency of updating the database of medicines and a partial transition of medical organizations to notification financing, which implies the provision of funds requested by a medical organization from the federal or regional budget without examination of the application and outside the established schedule. Information methods primarily imply the formation of a directed information (primarily news) stream, characterized by the stabilization of the coronavirus topic within the general information context. In the context of Russian reality, minimizing “empty” news blocks, providing only meaningful information related to the coronavirus, and excluding the possibility of manipulating the public for the sake of personal political and economic interests, can contribute to the early stabilization of the Russian economy and the labor market from the consequences of COVID-19.

The study can be improved by investigating COVID-19’s impact on a wider range of areas of professional activities and taking into consideration more complex mechanisms, related to government policies, lockdowns and etc., influencing unemployment and other macroeconomic indicators. Moreover, a more profound exploration of citizens’ psycho-

emotional state of mind and a broader selection of search queries on the Yandex search engine during the pandemic period would increase the significance of the following studies.

In spite of the fact that this study examines the impact of COVID-19 on the most affected sector of the Russian economy, the significance of the study to the whole Russian labor market is beyond question due to the high share of the selected sector in the total GDP of Russia and the high share of the able-bodied population of the Russian economy employed in the selected service sector branches.

The study confirms that coronavirus' physical spread directly impacted on elements of the Russian labor market, and informational spread indirectly impacted on the transformation of the external environment, as well as the behavior of society, which leads to the necessity of modeling information flows to minimize negative economic effects on the Russian labor market. That means that a similar influence may take place on international labor markets, which determines the possibility to apply the results of this study by authors outside Russia.

**Author Contributions:** Conceptualization, D.R.; methodology, A.I., E.K. and O.K.; software, A.I.; validation, A.I.; formal analysis, A.I.; investigation, A.I., E.K. and O.K.; resources, D.R.; data curation, O.K.; writing—original draft preparation, A.I., E.K. and O.K.; writing—review and editing, D.R. and A.I.; visualization, A.I.; supervision, D.R.; project administration, E.K.; funding acquisition, D.R. All authors have read and agreed to the published version of the manuscript.

**Funding:** This research was funded by Ministry of Science and Higher Education of the Russian Federation under the strategic academic leadership program 'Priority 2030' [(Agreement 075-15-2021-1333 dated 30 September 2021)].

**Institutional Review Board Statement:** Not applicable.

**Informed Consent Statement:** Not applicable.

**Data Availability Statement:** All used data are placed in the public domain and are available at the links: <https://rosstat.gov.ru/> (accessed on 25 May 2022); [https://datalens.yandex/7o7is1q6ikh23?tab=X1&utm\\_source=cbmain](https://datalens.yandex/7o7is1q6ikh23?tab=X1&utm_source=cbmain) (accessed on 25 May 2022); <https://wordstat.yandex.ru> (accessed on 25 May 2022).

**Acknowledgments:** The research is partially funded by the Ministry of Science and Higher Education of the Russian Federation under the strategic academic leadership program 'Priority 2030' (Agreement 075-15-2021-1333 dated 30 September 2021).

**Conflicts of Interest:** The authors declare no conflict of interest.

## References

- Adams-Prassl, Abi, Teodora Boneva, Marta Golin, and Christopher Rauh. 2020. Inequality in the impact of the coronavirus shock: Evidence from real time surveys. *Journal of Public Economics* 189: 104245. [CrossRef]
- Almomani, Hesham, and Wael Al-Qur'an. 2020. The extent of people's response to rumors and false news in light of the crisis of the Corona virus. *Annales Médico-Psychologiques, Revue Psychiatrique* 178: 684–89. [CrossRef] [PubMed]
- Anser, Muhammad Khalid, Zahid Yousaf, Muhammad Azhar Khan, Abdelmohsen A. Nassani, Saad M. Alotaibi, Muhammad Moinuddin Qazi Abro, Xuan Vinh Vo, and Khalid Zaman. 2020. Does communicable diseases (including COVID-19) may increase global poverty risk? A cloud on the horizon. *Environmental Research* 187: 109668. [CrossRef] [PubMed]
- Douglass, John Aubrey. 2020. Higher Education Is Key for the Post-COVID-19 Economic Recovery. *Berkeley Blog*, April 27. Available online: <https://blogs.berkeley.edu/2020/04/27/higher-education-is-key-for-the-post-covid-19-economic-recovery> (accessed on 25 May 2022).
- Forman, Rebecca, Rifat Atun, Martin McKee, and Elias Mossialos. 2020. 12 Lessons learned from the management of the coronavirus pandemic. *Health Policy* 124: 577–80. [CrossRef] [PubMed]
- Karlsson, Martin, Therese Nilsson, and Stefan Pichler. 2014. The impact of the 1918 Spanish flu epidemic on economic performance in Sweden: An investigation into the consequences of an extraordinary mortality shock. *Journal of Health Economics* 36: 1–19. [CrossRef] [PubMed]
- Laing, Timothy. 2020. The economic impact of the Coronavirus 2019 (COVID-2019): Implications for the mining industry. *The Extractive Industries and Society* 7: 580–82. [CrossRef] [PubMed]
- Lyócsa, Štefan, Eduard Baumöhl, Tomáš Výrost, and Peter Molnár. 2020. Fear of the coronavirus and the stock markets. *Finance Research Letters* 36: 101735. [CrossRef] [PubMed]

- Official News Group. n.d. Official News Group of RBC (*RosBusinessConsulting*) in Vkontakte. Available online: <https://vk.com/rbc> (accessed on 25 May 2022). (In Russian).
- Paz, Lourenço S. 2022. The China Shock Impact on Labor Informality: The Effects on Brazilian Manufacturing Workers. *Economies* 10: 109. [CrossRef]
- Rodionov, Dmitry Grigorievich, Evgenii Alexandrovich Konnikov, and Dmitry Aleksandrovich Alfer'ev. 2020. Informacionnyj kapital predpriyatiya kak celevoj pokazatel' razvitiya v ramkah cifrovyh ekonomicheskikh system [Information capital of an enterprise as a target indicator of development within the framework of digital economic systems]. *Ekonomicheskie Nauki* 190: 131–37.
- Russian Federal State Statistics Service. n.d. Russian Federal State Statistics Service: Socio-Economic Situation in Russia January–August 2020. Available online: <https://rosstat.gov.ru/storage/mediabank/eSPOpFTC/osn-08-2020.pdf> (accessed on 25 May 2022). (In Russian)
- Sadik-Zada, Elkhan Richard. 2020. Addressing the Growth and Employment Effects of the Extractive Industries: White and Black Box Illustrations from Kazakhstan. *Post Communist Economies* 33: 402–34. [CrossRef]
- Sadik-Zada, Elkhan Richard, Wilhelm Loewenstein, and Yadulla Hasanli. 2021. Production linkages and dynamic fiscal employment effects of the extractive industries: Input-output and nonlinear ARDL analyses of Azerbaijani economy. *Mineral Economics* 34: 3–18. [CrossRef]
- Tisdell, Clement A. 2020. Economic, social, and political issues raised by the COVID-19 pandemic. *Economic Analysis and Policy* 68: 17–28. [CrossRef] [PubMed]
- Yandex DataLens Public. n.d. Yandex DataLens Public: Coronavirus Dashboard. Available online: [https://datalens.yandex/7o7is1q6ikh23?tab=X1&utm\\_source=cbmain](https://datalens.yandex/7o7is1q6ikh23?tab=X1&utm_source=cbmain) (accessed on 25 May 2022). (In Russian).
- Yandex Wordstat. n.d. Yandex Wordstat: Statistics of Search Queries in Yandex. Available online: <https://wordstat.yandex.ru> (accessed on 25 May 2022). (In Russian).

## Article

# The Impact of the COVID-19 Pandemic on Economic Growth and Monetary Policy: An Analysis from the DSGE Model in Vietnam

Trung Duc Nguyen<sup>1</sup>, Anh Hoang Le<sup>2,\*</sup>, Eleftherios I. Thalassinos<sup>3,4</sup> and Lanh Kim Trieu<sup>5</sup>

<sup>1</sup> Faculty of Banking, No. 36 Ton That Dam Street, Nguyen Thai Binh Ward, District 1, Ho Chi Minh City 700000, Vietnam; trungnd@buh.edu.vn

<sup>2</sup> Institute for Research Science and Banking Technology, Banking University HCMC, No. 36 Ton That Dam Street, Nguyen Thai Binh Ward, District 1, Ho Chi Minh City 700000, Vietnam

<sup>3</sup> Faculty of Maritime and Industrial Studies, University of Piraeus, 185-33 Piraeus, Greece; thalassinos@ersj.eu

<sup>4</sup> Faculty of Economics, Management and Accountancy, University of Malta, 2080 Msida, Malta

<sup>5</sup> Faculty of Finance, Banking University HCMC, No. 36 Ton That Dam Street, Nguyen Thai Binh Ward, District 1, Ho Chi Minh City 700000, Vietnam; lanhtk@buh.edu.vn

\* Correspondence: anhhl\_vnc@buh.edu.vn

**Abstract:** Facing the current complicated situation of the COVID-19 pandemic, in addition to medical efforts on disease prevention and treatment, governments of countries also have to come up with solutions to deal with the negative impacts of the pandemic on the economy. This study aims to provide specific, comprehensive, and scientific estimates of the impact of the COVID-19 pandemic on the Vietnamese economy. By using the Bayesian method to estimate DSGE models, research results show that a shock increase by one standard deviation (about 1.49% increase in the probability of a COVID-19 outbreak) to the Covid status variable immediately reduces the output gap by 0.94%. However, this effect only lasts for one quarter, and the output gap widens again. Meanwhile, refinancing interest rates, inflation, and exchange rate changes also have an immediate decline in response to this shock, but the magnitude of the reduction is relatively small.

**Keywords:** monetary policy; the COVID-19 pandemic; policy responses; DSGE models

**Citation:** Nguyen, Trung Duc, Anh Hoang Le, Eleftherios I. Thalassinos, and Lanh Kim Trieu. 2022. The Impact of the COVID-19 Pandemic on Economic Growth and Monetary Policy: An Analysis from the DSGE Model in Vietnam. *Economies* 10: 159. <https://doi.org/10.3390/economies10070159>

Academic Editor: Ștefan Cristian Gherghina

Received: 10 May 2022

Accepted: 29 June 2022

Published: 1 July 2022

**Publisher's Note:** MDPI stays neutral with regard to jurisdictional claims in published maps and institutional affiliations.



**Copyright:** © 2022 by the authors. Licensee MDPI, Basel, Switzerland. This article is an open access article distributed under the terms and conditions of the Creative Commons Attribution (CC BY) license (<https://creativecommons.org/licenses/by/4.0/>).

## 1. Introduction

The COVID-19 pandemic warned the world about unpredictable and difficult-to-control macro impacts on the economy. Since the complicated COVID-19 pandemic situation, state governments make efforts to prevent and treat disease, and also have to cope with the effects on the economy (not to mention other social influences). In addition, the forced implementation of measures such as Social distancing and Lockdown has led to economic consequences, such as businesses closing, increasing unemployment rate, decreasing consumer demand, etc. From the beginning of 2020 until now, the global circulation of goods production and services has been suddenly interrupted, leading to a local shortage of production materials in many parts of the world. Therefore, the question is, what is the impact of the COVID-19 pandemic on the economy? What is the policy response to the new-normal situation, especially the monetary policy of the central banks of other countries, as well as in Vietnam? As we know, the objectives of the monetary policy of all countries are basically aimed towards stabilizing prices, controlling inflation, controlling unemployment rate, and stabilizing the economy.

There has been much research conducted in many countries and regions to find answers to the abovementioned problems. On the regional level, studies have confirmed the severe impact of the COVID-19 pandemic on the regional economy, and that monetary policy helps the regional economy cope with the consequences of COVID-19 (Aguilar et al. 2020; Cúrdia 2020). However, within individual countries, on the one hand,

the studies still show evidence of the severe impact of the COVID-19 epidemic on the economy, but on the other hand, the effectiveness of monetary policy is not the same (Pinshi 2020; Malata and Pinshi 2020; Zhang et al. 2021). Specifically, traditional monetary policy tools are not as effective as expected, or the policy lag is quite significant, leading central banks to actively consider applying non-traditional measures in management to deal effectively with immediate problems caused by the pandemic. Research results show that non-traditional tools are practical on time and are used by many central banks due to lessons learned from the global financial crisis in 2008.

In Vietnam, studies in the period from 2019 to the present still revolve around determining the consequences of the COVID-19 epidemic on the economy. In addition, the policy responses of the operator to the macro instability situation due to the COVID-19 epidemic also revolved around judgments based on the collected information. There have not been empirical studies to make specific conclusions and comprehensive estimates. This is also the driving force behind us to carry out this study. Unlike previous studies conducted in Vietnam, this study applies the DSGE model developed by the State Bank of Vietnam's Monetary Forecasting and Statistic Department in consultation with experts from IMF and JICA Japan, which is considered suitable for Vietnam's small and open economy to estimate the shocks that the model brings, thereby assessing the impact on the economy's aggregate demand. Moreover, to quantify the effect of the COVID-19 epidemic, we also adjusted this model based on the studies of Zheng and Guo (2013), and Zhang et al. (2021). Therefore, this study can provide specific, comprehensive, scientific estimates of the impact of the COVID-19 pandemic on the Vietnamese economy and the effectiveness of monetary policy in the past. Furthermore, our study also has another critical contribution: estimating the DSGE model by the Bayesian method for an open and small economy like Vietnam.

Following this introduction, we review the research related to this topic in Section 2. Section 3 presents the research methodology. Research results are presented in Section 4. Policy implications and conclusions are presented, respectively, in Section 5.

## 2. Previous Studies Related to Monetary Policy in the Period of COVID-19

An epidemic of acute respiratory infections caused by a new strain of Coronavirus (COVID-19) appeared in December 2019. On 31 January 2020, the World Health Organization (WHO) announced a worldwide health emergency. Facing the challenging situation of the epidemic, the governments of other countries, in addition to health efforts in disease prevention and treatment, have to strain themselves to cope with the consequences on the economy due to the instability caused by the COVID-19 outbreak.

There have been many studies conducted in many countries and regions around the world in recent times to find answers to the effects of the epidemic on the economy. For example, Aizenman et al. (2022) studied the impact of above-normal government spending during the COVID-19 pandemic on loan growth of commercial banks between 2019Q4 and 2020Q4. Research by Baker et al. (2020) assesses the economic impact of the COVID-19 pandemic on stock market volatility and economic uncertainty based on press. In addition to its impact on public health, Bartik et al. (2020) studied the impact of the COVID-19 pandemic on the performance of small businesses and examined the effectiveness of economic stimulus policies. In addition to the aforementioned case studies, other studies have also assessed the impact of the COVID-19 pandemic on consumer spending (Coibion et al. 2020), the labor market, inequality income (Campello et al. 2020; Forsythe et al. 2020), and business immunity (Ding et al. 2021).

The above studies have pointed to unexpected macroeconomic consequences of the COVID-19 pandemic. Thus, in addition to public health interventions (e.g., restricting movement, controlling migration, increasing immunization), governments worldwide have implemented various fiscal and monetary policies to combat the unintended consequences of the pandemic on the economy. Accordingly, many studies on fiscal and monetary policy responses during the COVID-19 pandemic have also been carried out. Some case studies included below.

Cortes et al. (2022) compared interventions taken by the Federal Reserve in response to the subprime crisis and the COVID-19 pandemic crisis. In essence, these two crises are different, the subprime lending crisis has an endogenous origin from the economy, while the crisis caused by the COVID-19 epidemic has an exogenous origin. The results of the study and comparison show that the interventions in both these crises reduce the risk in the stock markets in the countries. However, the spillover effects of interventions during the subprime crisis negatively affected the economy.

Zhang et al. (2021) studied the impact of the COVID-19 pandemic on sustainable economic growth, government debt, and income inequality in China by the NK-DSGE<sup>1</sup> model. The results show that the impact of the COVID-19 pandemic on aggregate demand and labor demand has posed severe challenges to the sustainable development of the economy and increasingly unequal societies. From the analysis of the pandemic's impact on aggregate demand, the study suggests that the goals of monetary policy should focus more on price stability. In addition, the decrease in labor demand leads to the proposal that monetary policy should focus on the goal of economic growth. The study concludes that, depending on the manifestations and impact of the COVID-19 pandemic, monetary policy focuses more on that goal towards stimulating consumption, reducing unemployment, reducing unequal societies, and improving the sustainability of China's economy.

Malata and Pinshi (2020) used an econometric framework with a self-regressing Bayesian vector approach to isolate the impact of monetary policy on inflation, output gap, and exchange rate, taking into account the volatility caused by the pandemic. The study confirms that the pressure caused by the COVID-19 epidemic affects the economy. Thus, to what extent can monetary policy obscure these effects? The study analyzed some tactics of the Central Bank of Congo (BCC) in response to the impact of the pandemic, such as easing monetary policy by buying large amounts of treasury bonds. This expanded monetary policy can revive the economy and save businesses, especially small and medium enterprises. In addition, the Central Bank of Congo also supports banks to help reduce lending conditions to make it easier for businesses to access credit.

Pinshi (2020) conducted a study on how the instability caused by the COVID-19 epidemic affects the economy's aggregate demand and the role of monetary policy in overcoming instability in the Congo through an experimental Bayesian VAR model. The shock analysis in the model shows that the impact of COVID-19 is quite significant on aggregate demand, prices, exchange rates, and trade openness, making it difficult for monetary policy intervention. Moreover, the model results show that the response of monetary policy is temporarily ineffective for at least 24 months. The uncertainty of COVID-19 reduces the ability of the Central Bank of Congo to affect the economy and control inflation. Therefore, the study proposes to consider non-traditional monetary policy management measures, such as buying many long-term treasury bonds and liquidity relief packages.

Cúrdia (2020) experimented with an econometric model to examine the effectiveness of an active interest rate cut in monetary policy management to cope with the expected impact of the COVID-19 pandemic. The data are taken from 1989 to the end of 2019. The macro indicators used in the model include Inflation Rate<sup>2</sup>, Growth in real GDP, Unemployment rate, Effective funds Rate<sup>3</sup>, and Long-term Unemployment Rate. The impact of the pandemic is simulated through two negative effects on the economy: (i) reduced labor productivity (because businesses produce fewer goods than before); (ii) reduced willingness-to-pay (due to travel restrictions, social distancing, closure of non-essential businesses) reduces overall demand in the economy.

Bhar and Malliaris (2021) modeled the effects of a non-conventional monetary policy approach based on the arguments of Friedman (1968)<sup>4</sup>, a Markov transition econometric model with monthly period data from 2002 to 2015 that examines the effectiveness of applying non-conventional monetary policy during the global financial crisis to reduce unemployment. The results show that non-conventional monetary policy with quantitative easing and targeting tools has had an impact in reducing the unemployment rate. The study

conducts a preliminary comparison of the balance sheet of the US Federal Reserve (Fed) during two crises (Global financial crisis and the COVID-19 pandemic), from which lessons may be drawn from experience for the Fed in operating monetary policy to contribute to mitigating the economic and financial impacts of the COVID-19 pandemic on businesses and households.

[Dorđević et al. \(2020\)](#) study the application of non-traditional tools in monetary policy administration to mitigate the economic consequences of the COVID-19 pandemic. The tools used are quantitative easing (QE) and quantitative alleviation. The study analyzes the effectiveness of applying these tools in the central banks of the USA, Japan, Europe, and other central banks. The use of these tools more or less affects aggregate demand, inflation, and GDP. The paper provides lessons learned for the Republic of Serbia in considering the application of these tools.

[Aguilar et al. \(2020\)](#) presented an overview of the timely and robust responses of the European Central Bank to the COVID-19 pandemic, and the meetings of The Committee on Economic and Monetary Affairs took place continuously. Various monetary policy measures have been applied since the outbreak of the COVID-19 pandemic. The paper evaluates these measures, explains their application, and examines and analyzes the impact of the efforts on the euro area economy. The study was updated in a report on 9 February 2021 ([Aguilar et al. 2020](#)).

In addition to the above studies, in recent times, assessing the impact of the COVID-19 pandemic on the macroeconomy of countries through the DSGE model is receiving much attention, since considering the impact of shocks through the DSGE model can give an overview of these impacts on the macro variables of the economy. Moreover, the DSGE model is also built on the basis of the theory of the real business cycle and shows the response of all sectors in the economy to shocks. Case studies include [Eichenbaum et al. \(2022\)](#) and [Eichenbaum et al. \(2021\)](#). [Eichenbaum et al. \(2022\)](#) studied epidemic factors in the Neoclassical and New-Keynesian Models, the basic models of the DSGE model. The results of [Eichenbaum et al. \(2022\)](#) show similar peak-to-trough volatility in both consumption, investment, and output during the COVID-19 pandemic. Following that study, [Eichenbaum et al. \(2021\)](#) extended the epidemiological model to study the interaction between economic decisions and epidemics. The results of [Eichenbaum et al. \(2021\)](#) imply that people cut back on consumption and employment to reduce the risk of infection. These decisions reduce the epidemic's severity but exacerbate the scale of the associated recession.

In Vietnam, in recent years, there have also been many studies on the impact of the COVID-19 pandemic on the economy, as well as on the operation of monetary policy in the context of the pandemic. Some case studies include those below.

[Pham Thanh Ha \(2021a, 2021b\)](#) gave an overview of the monetary policy operation of the State Bank of Vietnam, along with monetary policy and fiscal policy in 2020 in the context of the COVID-19 pandemic taken place in 2019, and the orientation of monetary policy management in 2021. According to the study, the State Bank of Vietnam has had flexible responses in its management activities to control inflation, stabilize the macroeconomy, support production and business activities, and create momentum for a recovering economy. The results achieved in coordinating and administering Vietnam's macro policies form an essential foundation for the operation orientation in 2021.

[NEU-JICA \(2020\)<sup>5</sup>](#) conducted a comprehensive analysis and assessment of the impact of the COVID-19 epidemic on the economy. The study evaluates the effectiveness of Vietnam's macro policies (including monetary policy) in responding to that impact, and makes appropriate recommendations for policymakers. Accordingly, the assessment stated that the interest rate tool of the monetary policy in this period would be less effective, so the credit support policy needs to apply other measures, in addition to reducing interest rates.

[Bui Duy Hung \(2020\)](#) researches monetary policy management in the context of the COVID-19 epidemic taking place in Vietnam, as well as around the world, from the end of 2019 until now. In order to limit the harmful effects of the outbreak on the economy, the

article outlines flexible response measures in monetary policy management of the central banks of other countries, as well as the State Bank of Vietnam, such as cutting interest rates, supporting liquidity, and supporting businesses from there towards the common goal of supporting the economy. The article only stops at analyzing and synthesizing non-traditional measures of some central banks, giving preliminary comments on how the application of these measures has brought about specific positive effects.

In summary, it can be seen that domestic studies revolve around analyzing the policy responses of executives to the macroeconomic instability caused by the COVID-19 epidemic, mainly assessing the perception of the situation. There is no long-term-oriented policy and no empirical studies to make more specific and comprehensive estimates based on the collected information. Unlike previous studies, in this study, we try to make estimates of the impact of the COVID-19 pandemic on macro variables of the Vietnamese economy. At the same time, through the DSGE model estimated by the Bayesian method, we also show the response of variables related to monetary policy to the COVID-19 pandemic shock.

### 3. Methodology

#### 3.1. Dynamic Stochastic General Equilibrium (DSGE)

From Table 1, we see that there are many methods to experimentally transmit monetary policy to the economy, among which the DSGE model is a comprehensive assessment model of shocks that affect macro variables.

**Table 1.** Summary of research on monetary policy management during the COVID-19 pandemic.

No.	Author	Research Objective	Research Methods	Scope of Study and Research Data
1	Zhang et al. (2021)	Empirical research on the impact of the COVID-19 pandemic on economic growth, government debt, income inequality.	NK-DSGE Model	China 1996Q1–2020Q3
2	Bhar and Malliaris (2021)	Modeling non-traditional monetary policy during the global financial crisis compared with the COVID-19 epidemic to provide lessons for the Fed.	Markov switching model	USA, 2002–2015
3	Dorđević et al. (2020)	Studying the application of non-traditional monetary policy tools at some major central banks to draw lessons for Serbia.	Analyze, evaluate based on data	USA, Japan, Europe, and some other central banks
4	Malata and Pinshi (2020)	Estimating measures in monetary policy management aimed at blurring the impacts of the COVID-19 pandemic.	Bayesian VAR	Congo-Brazzaville, between January 2012 and April 2020
5	Pinshi (2020)	Researching the instability caused by COVID-19 reflected through the VIX and WPUI indexes on the economy and monetary policy management.	Bayesian VAR	Congo-Brazzaville, between January 2009 and April 2020
6	Aguilar et al. (2020)	Analyzing and evaluating the vigorous measures of the European Central Bank to the impact of the COVID-19 pandemic.	Analyze and estimate based on data	Châu Âu, between 2020 and February 2020
7	Cúrdia (2020)	Estimating the impact of the Fed's monetary policy rate cut in response to the COVID-19 pandemic.	Dynamic term structure models (DTSMs)	USA, between 1987 and 2019

The DSGE model is based on Business Cycle Theory (see Figure 1). The real business cycle theory suggests that business cycles are how the economy responds to shocks, in which supply-side shocks such as labor productivity or technology shocks contribute the most. The model also eliminates demand-side shocks, as well as the need to intervene in the economy through short-term tools, such as fiscal policy and monetary policy. With the assumption that prices and wages are adjusted dynamically, this model does not recognize the effect of monetary policy on output and other macro variables. The DSGE model only began to be developed in the 1980s after Lucas' criticism comparing it to traditional macro-econometric models. However, the model has received much attention from academic researchers and policymakers at central banks, especially banks with inflation targeting. More and more central banks of developed and developing countries are building their own



DSGE models for economic analysis and forecasting, such as Canada’s central bank (ToTEM model), Bank of England (BEQM model), Central bank of Chile (MAS model), Central reserve bank of Peru (MEGAD model), ECB (NAWM model), Central Bank of Norway (NEMO model), Central Bank of Sweden (RAMSES model), and the Fed (SIGMA model).

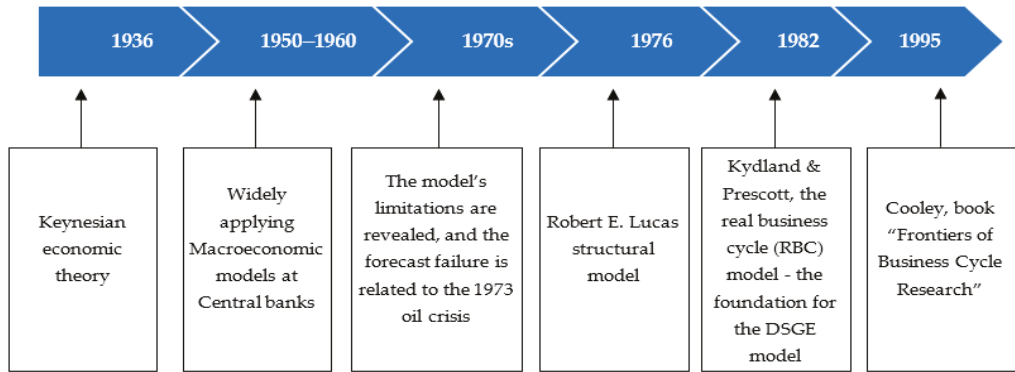


Figure 1. The development of DSGE model.

The paper uses the DSGE model built by the State bank of Vietnam’s Monetary Forecasting and Statistic Department in consultation with IMF and JICA experts, which is suitable for Vietnam’s small and open economy to estimate shocks, thereby assessing the impact on the aggregate demand of the economy. At the micro level, the DSGE Model comes from optimizing the interests of the actors in the economy, including consumers, businesses, and the government. Specifically, Consumers seek to optimize utility according to their budget and firms seek to maximize profits according to their level of technology. Governments run the economy through the tools of monetary policy.

Moreover, we also adjusted this model based on the research of [Zheng and Guo \(2013\)](#). To assess the impact of the COVID-19 epidemic on growth and monetary policy, we add the variable  $covid_t$  to the DSGE model, which represents the probability of an outbreak of the COVID-19 epidemic. The reality of Vietnam’s economic results in 2020 has shown that Vietnam can both control the COVID-19 pandemic well and ensure the development speed of the economy through solutions that flexibly combine both fiscal and monetary policy. Therefore, Vietnam’s inflation in 2020 remains stable through a series of macro measures, and there is no sign of high inflation as in some parts of the world. This also reflects the current situation of pandemic shock in Vietnam, which affects demand more than supply. Therefore, in this study, we evaluate the impact of COVID-19 on economic growth as a demand shock.

The proposed DSGE model for this study is as follows:

Equation (1) is built based on the IS curve equation for the small and open economy. In this equation,  $x_t$  is Vietnam output gap. The rest of the world is represented by  $us_t$ , which is the US output gap. The US output gap is chosen to represent the rest of the world in the case study in Vietnam because the import–export turnover between Vietnam and the US accounts for the largest proportion of the total import–export turnover of Vietnam. The current output gap of Vietnam depends on future expectations ( $x_{t+1}$ ). In this model, the SBV’s refinancing rate ( $r_t$ ) is expected to have a negative effect on output gap. At the same time, current economic growth depends on future inflation ( $p_{t+1}$ ).  $q_t$  is the Terms of Trade of Vietnam. According to growth theory, current economic growth also depends on the Terms of Trade. The impact of the COVID-19 pandemic ( $covid_t$ ) is expected to

have a negative impact on the output gap.  $z_t$  is a state variable, representing the shock of technological change.

$$x_t = x_{t+1} - (\beta_1 + \beta_2) \times (r_t - p_{t+1}) + \beta_3 z_t - \beta_4 (\beta_1 + \beta_2) \Delta q_{t+1} + \frac{\beta_2}{\beta_1} us_{t+1} - \beta_{13} covid_t \quad (1)$$

$$\beta_2 = \beta_4 (2 - \beta_4) (1 - \beta_1) \quad (2)$$

Equation (3) is built based on the Phillips curve, in which, current inflation ( $p_t$ ) depends on expectations of future inflation ( $p_{t+1}$ ) and current and future change in the output gap of Vietnam. Moreover, unlike the traditional Phillips curve equation, as suggested by [Zheng and Guo \(2013\)](#), we add the impact of current and future Terms of Trade to reflect an open economy more precisely.

$$p_t = \beta_5 p_{t+1} + \beta_4 \beta_5 \Delta q_{t+1} - \beta_4 \Delta q_t + \frac{\beta_6}{\beta_1 + \beta_2} (x_{t+1} - x_t) \quad (3)$$

$$\beta_5 = \frac{\beta_6}{(\beta_1 + \beta_2)} + 1 \quad (4)$$

In this study, we assume that the central bank adjusts interest rates in response to changes in inflation and real output. Moreover, [Taylor \(2000\)](#) also argues that central banks in emerging economies should react to changes in exchange rates to improve the effectiveness of monetary policy. Accordingly, we have the following equation:

$$r_t = \beta_7 r_{t-1} + (1 - \beta_7) (p_t + x_t + \Delta e_t) + u_{rt} \quad (5)$$

This study also assumes that purchasing power parity (PPP) holds. Therefore, changes in the nominal exchange rate would be expressed as:

$$\Delta e_t = p_t - p_{ust} - (1 - \beta_4) \Delta q_t \quad (6)$$

The remaining variables in the model include Vietnam’s Terms of Trade, technology change, the US output gap, US inflation, and the probability of disease outbreaks. COVID-19 is assumed to be exogenous and has an appropriate growth rate. These variables are expressed in the following equations:

$$\Delta q_t = \beta_8 \Delta q_{t-1} + \varepsilon_{qt} \quad (7)$$

$$z_t = \beta_3 z_{t-1} + \varepsilon_{zt} \quad (8)$$

$$us_t = \beta_{12} us_{t-1} + \varepsilon_{ust} \quad (9)$$

$$p_{ust} = \beta_{10} p_{ust-1} + \varepsilon_{pust} \quad (10)$$

$$u_{rt} = \beta_{11} u_{rt-1} + \varepsilon_{ut} \quad (11)$$

$$covid_t = \beta_{14} covid_{t-1} + \varepsilon_{covidt} \quad (12)$$

where:

- $x_t$ : Vietnam output gap
- $r_t$ : Refinancing rate of the State bank of Vietnam
- $p_t$ : Inflation rate of Vietnam
- $e_t$ : USD to VND exchange rate
- $us_t$ : US output gap
- $q_t$ : Terms of Trade of Vietnam
- $p_{ust}$ : Inflation rate of US
- $covid_t$ : Probability of outbreak of COVID-19
- $\varepsilon_{qt}, \varepsilon_{zt}, \varepsilon_{ust}, \varepsilon_{pust}, \varepsilon_{ut}, \varepsilon_{covidt}$ : Shocks

In equations from (1) to (12), the main equations of the DSGE model include: (i) Equation (1) is the equation of the line IS, the aggregate demand equation,  $x_t$  in (1) is the unobserved control variable in the model, which represents GDP (output gap is the difference between actual GDP and its potential output). Equation (3) is the Phillips curve equation representing the relationship between inflation and GDP. Equation (5) is an interest rate equation based on Taylor's Rule. Equation (6) is the exchange rate equation.

### 3.2. Estimators of DSGE

Some estimators of DSGE can be mentioned as: (i) Calibration and parameter estimation, (ii) Generalized Method of Moments estimation of equations (GMM); (iii) Maximum Likelihood Estimation (MLE); (iv) Impulse response matching Estimation; and (v) Bayesian Estimation.

A review of related studies shows that the DSGE models are mostly estimated by the Maximum Likelihood Estimation—MLE—in previous studies. However, the limitation on the time series size of the variables affects the estimation of the parameters in the DSGE model by the MLE method. To overcome this limitation, we use the Bayesian method to estimate the DSGE model with the Vietnamese economy. In addition to the observed data, the Bayesian method also uses the a priori information of the parameters in the model obtained from previous studies. This information is expressed as a priori distribution. Following this, the Bayesian method combines the observed data with the a priori distribution to create the posterior distribution of the parameters in the model. This posterior distribution contains all the information about the parameters in the DSGE model. Therefore, this estimation method overcomes the data limitation of the time series in the DSGE model.

In the scope of this paper, the authors use data collected from the International Monetary Fund (IMF) with quarterly data for the period of 1996–2020. The results from the DSGE model built for the Vietnamese economy show the transmission effects of macro factors on the economy, especially the impact of the COVID-19 pandemic on Vietnam's growth and monetary policy during the epidemic period from the end of 2019 until the end of 2020. In addition, we also analyzed the current situation of monetary policy management of the State Bank of Vietnam, in order to have empirical evidence to better explain monetary policy management before and during the epidemic outbreak.

## 4. Results

### 4.1. Research Context

The COVID-19 pandemic has had a huge impact on most countries around the world. Economic growth in many countries around the world has been significantly reduced since the outbreak of the pandemic. Therefore, the central banks of countries have come up with many policies to respond to the pandemic situation.

The State Bank of Vietnam has made quite detailed reports on monetary policy implementation, especially timely responses to the COVID-19 pandemic. Some typical activities can be summarized as follows (SBV 2020):

Promptly direct credit institutions to review customer situations, assess the impact of the COVID-19 epidemic on customers, and develop customer support scenarios when necessary.

Organize a conference to connect six key economic regions between banks and businesses to listen to opinions directly.

Direct credit institutions to take advantage of internal financial resources to implement programs, such as salary cuts, no dividends, cost reduction, profit reduction, etc., to support customers. Credit institutions have carried out debt restructuring, interest rate exemptions and reductions, new loans with preferential interest rates, exemption and reduction of payment fees, etc.

Implement credit growth and provide capital on time to the economy:

- SBV actively adjusted to increase credit growth in a few priority areas, directed credit institutions to study internal processes to reduce loan procedures, increase information technology applications, and increase loans unsecured by assets, etc.
- Implemented specific credit policies for the export and agriculture sectors.
- Promoted credit to poor households and policy beneficiaries.

Improve the business environment in the monetary and banking sector as part of the state administrative reform program. Increase the application of online public services and processing through the network environment. The year 2020 is the 5th consecutive year that the State Bank of Vietnam leads the PAR index ranking.

The scheme to restructure credit institutions associated with bad debts has been drastically implemented.

Promote the development of non-cash payments, develop e-banking, apply the achievements of the industrial revolution 4.0, but still ensure safety, security, and confidentiality. Research and supplement legal regulations related to digital banking and online banking services . . .

Actively, prudently and flexibly implement through monetary policy tools:

- For interest rates: in 2020, interest rates have been adjusted three times with a total reduction of about 1.5–2% to support liquidity and create conditions for credit institutions to access financial capital from SBV at low cost, reducing the ceiling interest rate of VND deposits by 0.6–1% for terms of less than 6 months, and reducing the ceiling interest rate of VND short-term loans by 1.5% for priority sectors. All of these interest rate reductions are aimed at helping credit institutions reduce costs, creating conditions for businesses and people to access capital at a low cost.
- For exchange rates: continue to operate the exchange rate tool flexibly, actively communicate, monitor exchange rate movements, and announce the central exchange rate daily, ready to intervene to stabilize the market. By the end of 2020, the central exchange rate remains at 23,131 VND/USD, ensuring stability in the foreign currency market, and supplementing the state's foreign exchange reserves.

Thus, in addition to some administrative measures, such as guiding credit institutions to implement measures to support businesses and people, in 2020, SBV has operated through conventional monetary policy tools, such as interest rates and exchange rates, while unconventional monetary policy tools have not been used much.

Nguyen Minh Cuong (Nguyen Minh Cuong 2021), ADB's chief economist in Vietnam, in his article affirmed Vietnam's success in 2020, with economic growth reaching 2.91%, while many countries have negative economic growth. The article made insightful comments related to the monetary policy implementation of the State Bank of Vietnam in 2020, thereby recommending some notes for 2021. The analysis of the article also shows the timely flexible responses and certain achievements of the State Bank of Vietnam in monetary policy management.

#### 4.2. Description of the Variables in the Model

The study used quarterly data for the period 1996Q1–2020Q4, including 100 observations. The variables in the DSGE model include the refinancing interest rate of SBV ( $r$ ), the inflation rate of Vietnam ( $p$ ), the USD/VND exchange rate ( $e$ ), and Terms of Trade ( $q$ ). In addition to the above variables, for the DSGE model to consider the impact of the rest of the world on Vietnam, we also include the variable ( $us$ ) representing the output gap of the US and the variable ( $pus$ ) representing US inflation. Descriptive statistics of the variables in the model are presented in Table 2.

**Table 2.** Descriptive statistics.

Variable	Obs	Mean	Std. dev.	Min	Max
$r$	100	7.85	3.53	4.00	18.90
$p$	100	1.44	1.86	−1.87	8.94
$e$	100	17,805.92	3702.64	11,013.00	23,235.00
$q$	100	104.11	3.28	94.27	110.71
$us$	100	−1.17	2.11	−10.08	2.14
$pus$	100	0.20	0.31	−1.01	0.85

Figure 2 shows the fluctuations of the refinancing interest rate, Vietnam’s inflation, and the US output gap from the first quarter of 1996 to the fourth quarter of 2020. Accordingly, visually, the refinancing interest rate fluctuates in the same direction as inflation, representing the response of monetary policy. Except for the period of the COVID-19 outbreak from the end of 2019, the US output gap fluctuated inversely with Vietnam’s refinancing interest rate and inflation during the study period before the epidemic outbreak.

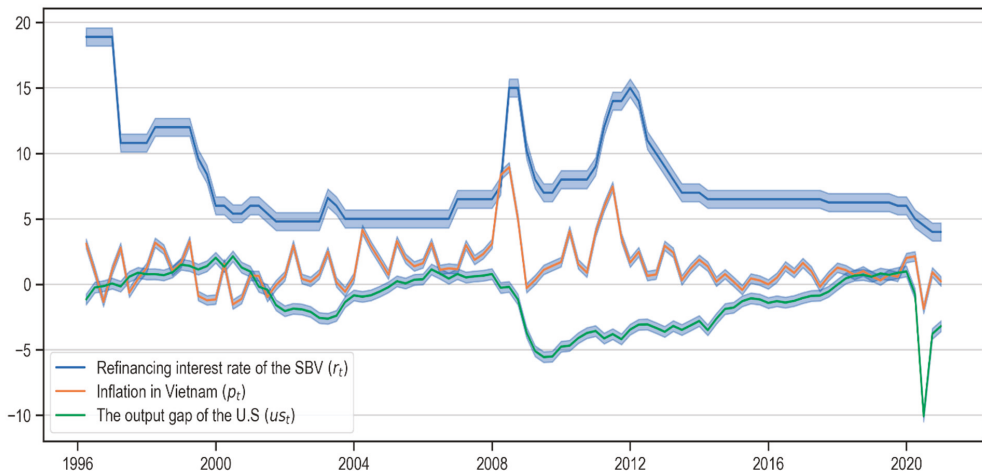
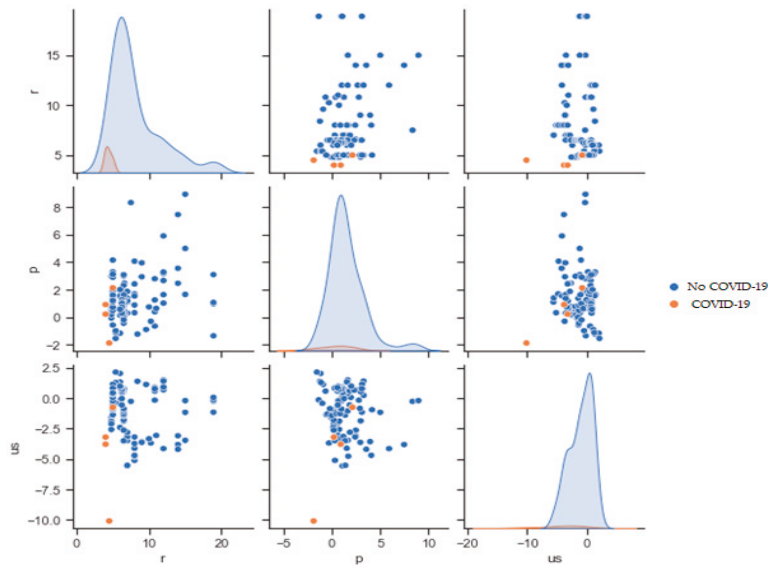
**Figure 2.** Movements of refinancing interest rate, inflation in Vietnam, and the output deviation of the US in the period from 1996Q1 to 2020Q4.

Figure 3 shows the relationship between these variables before and during the COVID-19 outbreak. Specifically, the orange points represent the value pairs of the variables of Vietnam’s refinancing interest rate, Vietnam’s inflation, and the US output gap during the COVID-19 outbreak period, while the blue points represent pairs of these variables in the period before the outbreak. Figure 3 shows the orange points evenly distributed in the lower and left quadrants of the graph. This result shows that, during the epidemic outbreak period, the value pairs of the variables of Vietnam’s refinancing interest rate, Vietnam’s inflation, and the US output gap all received lower values than before. This result indicates the simultaneous decrease of the variables of Vietnam’s refinancing interest rate, Vietnam’s inflation, and the US output gap during the outbreak period.



**Figure 3.** Correlation between Vietnam’s refinancing interest rate, inflation, and US output gap before and during the COVID-19 outbreak.

For the DSGE model’s parameter estimation results to be reliable, the time series in the DSGE model must be stationary. Therefore, we perform the Dickey–Fuller test to evaluate the stationarity of the time series in the model. The test results are presented in Table 3:

**Table 3.** Dickey–Fuller Test.

Variable	Test Statistic	MacKinnon Approximate <i>p</i> -Value	Dickey–Fuller Critical Value		
			1%	5%	10%
<i>r</i>	−3.249	0.0173	−3.511	−2.891	−2.58
<i>p</i>	−5.407	0.0000	−3.511	−2.891	−2.58
<i>us</i>	−3.01	0.0340	−3.511	−2.891	−2.58
<i>e</i>	−1.316	0.6219	−3.511	−2.891	−2.58
<i>q</i>	−2.143	0.2274	−3.511	−2.891	−2.58
<i>pus</i>	−9.931	0.0000	−3.511	−2.891	−2.58
<i>de</i>	−10.195	0.0000	−3.513	−2.892	−2.581
<i>dq</i>	−7.397	0.0000	−3.513	−2.892	−2.581

The Dickey–Fuller test results show that the variables of refinancing interest rate of the State Bank of Vietnam (*r*), inflation of Vietnam (*p*), output gap of the US (*us*), and inflation of America (*pus*) all stop at the original string. However, the USD/VND exchange rate (*e*) and Terms of Trade (*q*) stop at the first difference. Therefore, we use the first difference of the two variables instead of the original series when estimating the DSGE model.

Next, we use the correlation coefficient matrix to consider the correlation between the variables in the research model. Figure 4 shows that the correlation coefficient between the pairs of variables in the model ranges from −0.32 to 0.36. Thus, the variables in the model have a low correlation with each other. This result also shows that multicollinearity does not occur in the research model.

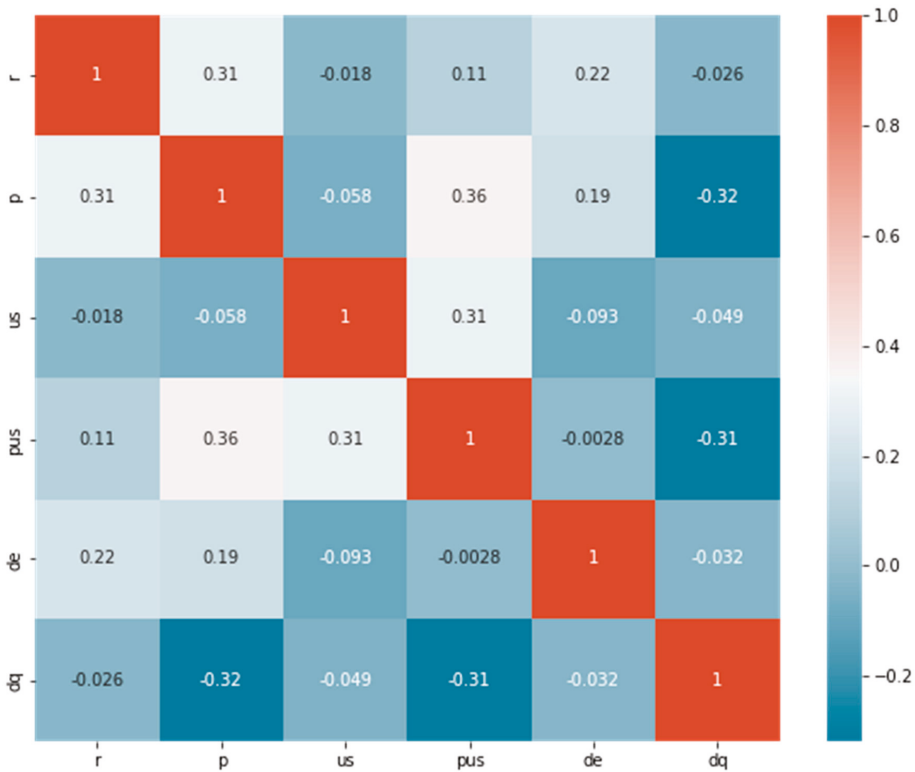


Figure 4. Correlation matrix between variables in the model.

4.3. The Prior Distributions of the Parameters in the DSGE Model

An important problem in the Bayesian method is determining the appropriate prior distributions for the parameters in the model. In this study, we determine the prior distributions for the parameters in the DSGE model based on the research of Zheng and Guo (2013), specifically as shown in Table 4:

Table 4. The prior distributions of the parameters in the model.

Parameter	Interpretation	Density Function	Para (1)	Para (2)
$\beta_1$	Intertemporal substitution elasticity	Beta	0.50	0.20
$\beta_3$	AR (1) for technology shock	Beta	0.50	0.20
$\beta_4$	Degree of openness	Beta	0.25	0.05
$\beta_6$	Inflation–output trade-off	Gamma	0.50	0.25
$\beta_7$	Interest rate smoothing parameter	Beta	0.50	0.20
$\beta_8$	AR (1) for terms of trade shock	Beta	0.50	0.20
$\beta_{10}$	AR (1) for the US inflation shock	Beta	0.50	0.20
$\beta_{11}$	AR (1) for the interest rate	Normal	2.00	2.00
$\beta_{12}$	AR (1) for the US output gap shock	Beta	0.50	0.20

**Table 4.** *Cont.*

Parameter	Interpretation	Density Function	Para (1)	Para (2)
$\beta_{13}$	Persistence of pandemic probability shock in the output gap	Beta	0.70	0.10
$\beta_{14}$	AR (1) for the pandemic probability shock	Normal	0.0822	0.0016
$\sigma_z$	Std. dev. of technology shock	Inverse gamma	0.01	0.01
$\sigma_{dq}$	Std. dev. of terms of trade shock	Inverse gamma	0.01	0.01
$\sigma_u$	Std. dev. of the monetary policy shock	Inverse gamma	0.01	0.01
$\sigma_{pus}$	Std. dev. of the US inflation shock	Inverse gamma	0.01	0.01
$\sigma_m$	Std. dev. of output gap shock	Inverse gamma	0.01	0.01
$\sigma_{covid}$	Std. dev. of the pandemic probability shock	Inverse gamma	0.01	0.01

The prior distributions of the parameters related to the impact of the COVID-19 epidemic in the DSGE model are proposed by us according to the study of Zhang et al. (2021). Specifically, the parameter  $\beta_{13}$  representing the impact of COVID-19 on the output gap has a prior distribution of Beta (0.7, 0.1). Meanwhile, the parameter  $\beta_{14}$  represents the probability that the outbreak has a prior distribution of Normal (0.0822, 0.0016). In the past, countries have been racing to produce vaccines to prevent the spread of the COVID-19 pandemic. In addition, vaccination rates have increased in most countries and continents. Therefore, in this study, we believe the outbreak probability is 8.22% as suggested by Zhang et al. (2021). Moreover, the selection of the outbreak probability of 8.22% is also based on the geographical similarity between the two neighboring countries. More specifically, Vietnam and China are also two countries with similar political institutions. Therefore, the response of two countries with the same institutions to the risk of disease may be similar.

Finally, we propose an inverse-gamma distribution (0.01, 0.01) for all standard deviation parameters in the model.

4.4. The Posterior Distributions of the Parameters in the DSGE Model

Bayesian analysis is used by us with the Metropolis–Hastings algorithm. The size of MCMC sequences corresponding to the parameters is 15,000, of which 2500 samples are removed in the Burn-in phase. Thus, the size of MCMC sequences corresponding to the parameters to form the posterior distribution is 12,500. The results of the DSGE model estimation by Bayesian method are presented in Table 5:

**Table 5.** Estimation results of DSGE model by Bayes method.

Parameter	Interpretation	Mean	Std. dev.	MCSE	Median	[95% Cred. Interval]	
$\beta_1$	Intertemporal substitution elasticity	0.3859	0.0004	0.0001	0.3857	0.3855	0.3869
$\beta_4$	Degree of openness	0.9700	0.0043	0.0012	0.9698	0.9632	0.9766
$\beta_3$	AR (1) for technology shock	0.8577	0.0003	0.0001	0.8577	0.8571	0.8581
$\beta_{13}$	Persistence of pandemic probability shock in the output gap	0.9623	0.0003	0.0001	0.9623	0.9618	0.9627
$\beta_6$	Inflation–output trade-off	0.0979	0.0027	0.0008	0.0983	0.0933	0.1021
$\beta_7$	Interest rate smoothing parameter	0.9204	0.0012	0.0003	0.9205	0.9184	0.9222
$\beta_8$	AR (1) for terms of trade shock	0.9240	0.0004	0.0001	0.9239	0.9234	0.9246



Table 5. Cont.

Parameter	Interpretation	Mean	Std. dev.	MCSE	Median	[95% Cred. Interval]	
$\beta_{11}$	AR (1) for the Interest rate	-0.3409	0.0034	0.0009	-0.3408	-0.3463	-0.3355
$\beta_{10}$	AR (1) for the US inflation shock	0.0000	0.0000	0.0000	0.0000	0.0000	0.0001
$\beta_{12}$	AR (1) for the US output gap shock	0.5210	0.0019	0.0005	0.5209	0.5182	0.5241
$\beta_{14}$	AR (1) for the pandemic probability shock	-0.1419	0.0120	0.0033	-0.1408	-0.1616	-0.1234
$\sigma_z$	Std. dev. of technology shock	0.0002	0.0001	0.0000	0.0002	0.0001	0.0003
$\sigma_{dq}$	Std. dev. of terms of trade shock	1.0873	0.0005	0.0001	1.0875	1.0863	1.0879
$\sigma_n$	Std. dev. of the monetary policy shock	1.4265	0.0010	0.0003	1.4262	1.4251	1.4282
$\sigma_{pus}$	Std. dev. of the US inflation shock	2.7875	0.0172	0.0047	2.7861	2.7601	2.8161
$\sigma_m$	Std. dev. of output gap shock	1.7278	0.0004	0.0001	1.7278	1.7270	1.7285
$\sigma_{covid}$	Std. dev. of the pandemic probability shock	1.4851	0.0012	0.0003	1.4845	1.4833	1.4877

Sample: 1996q2 to 2020q4; MCMC iterations: 15,000; Burn-in: 2500; MCMC sample size: 12,500

Table 5 shows that the 95% confidence intervals of the parameters are clearly in the positive or negative range; none of the 95% confidence intervals contain the value 0. With Equation (1), the parameter  $\beta_1$  takes a positive value (since the 95% confidence interval of this parameter is in the positive range). Moreover, the parameter  $\beta_2$  calculated according to Equation (2) receives a positive value. Therefore, an increase in the refinancing interest rate harms the output gap. At the same time, expectations of rising inflation in the future widen the current output gap, by boosting current consumption with greater purchasing power. The parameter  $\beta_3$  has a positive value (since the 95% confidence interval of this parameter is in the positive range), indicating that technological growth affects the increasing output gap. In addition, the research results also show that the output gap of the US has a positive impact on the output gap of Vietnam. Therefore, the US economic growth also has a positive impact on Vietnam's economic growth.

Table 5 also shows that the coefficient  $\frac{\beta_6}{\beta_1 + \beta_2}$  in Equation (3) has a positive value. Thus, future growth expectations increase current inflation by boosting current consumption. With Equation (5), the coefficient  $(1 - \beta_7)$  takes a positive value, the 95% confidence interval of parameter  $\beta_7$  has an upper-bound value less than 1. Therefore, the increase in output gap and inflation leads to the SBV's response through an increase in the refinancing interest rate.

The above arguments help us explain the impact of the COVID-19 epidemic on economic growth and monetary policy. Specifically, the impact of the COVID-19 epidemic on the output gap is expressed through the parameter  $\beta_{13}$ . Table 5 shows that the parameter  $\beta_{13}$  has a positive value (since the 95% confidence interval of this parameter is in the positive range). Thus, the probability of an outbreak of the COVID-19 epidemic negatively affects the output gap. Holding other factors constant, as above mentioned, a decrease in the output gap reduces inflation. At the same time, monetary policy immediately responds to this situation by reducing the refinancing interest rate by the SBV.

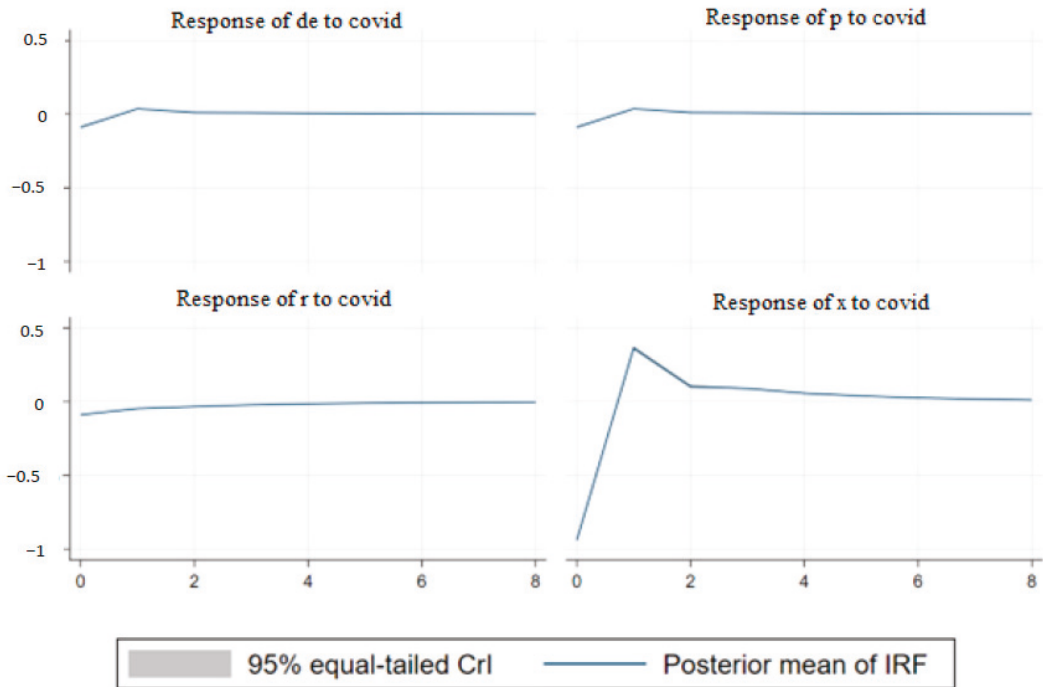
The more specific effects of the transmission channel analyzed above are measured through the results of the impulse–response function shown below.

#### 4.5. The Impulse–Response Function

The state–space form allows us to trace the path of control or state variable in response to a shock to a state variable. This path is called an impulse–response function (IRF), a complete set of impulse responses of variables to each shock.

The state variable *covid* represents the probability of an outbreak of COVID-19. A shock to the variable *covid* would indicate an increased risk of disease outbreaks, and the IRF finds out how this shock causes temporary effects on the output gap, inflation, and the refinancing interest rate. Figure 5 shows that a shock of one standard deviation increase (about 1.49% increase in the probability of a COVID-19 outbreak) to the state variable *covid* immediately reduces the output gap by 0.94%; however, this effect only lasts for 1 quarter, and the output gap then increases again. Meanwhile, refinancing interest rate, inflation,

and exchange rate changes also have an immediate decline in response to this shock, but the magnitude of the reduction is relatively small.



**Figure 5.** The response of Vietnam’s output gap, refinancing interest rate, inflation, and exchange rate changes to the shock of the COVID-19 outbreak.

Figure 6 shows the response of Vietnam’s output gap, refinancing interest rate, inflation, and exchange rate changes to a monetary policy change shock. The state variable  $u$  models monetary policy changes that occur in the refinancing interest rate for reasons other than inflation, output gap, and changes in the exchange rate. A shock to  $u$  is an unexpected increase in interest rates and the IRF finds out how this shock affects the variables in the model. A shock of one standard deviation increase in the state variable  $u$  causes the interest rate to increase immediately by about 1.12%, and this effect lasts for 6 quarters before disappearing. An increase in refinancing interest rate leads to a sharp decrease in the output gap, about 3.15%, and a slight decrease in inflation, about 0.3%. This result also shows that inflation seems to be less sensitive to the policy interest rate.

The response of Vietnam’s output gap, refinancing interest rate, inflation, and exchange rate changes to a technology change shock are shown in Figure 7. The state variable  $z$  models the rate of technology change and is considered an exogenous variable in the growth model. A shock that increases by one standard deviation of the state variable  $z$  causes the output gap to increase immediately, while the other variables have almost no response. The results are consistent with many previous studies that suggest that technological change has a positive impact on economic growth. However, it is worth mentioning here that the increase, although lasting for 6 quarters, is relatively small. This result reflects that the economy’s ability to absorb technology is very low.

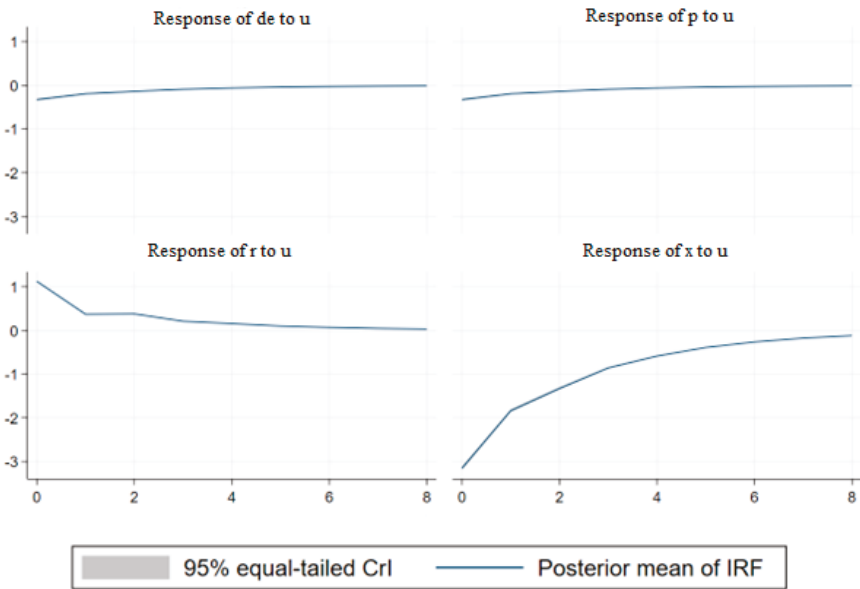


Figure 6. Response of Vietnam’s output gap, refinancing interest rate, inflation, and exchange rate changes to a monetary policy change shock.

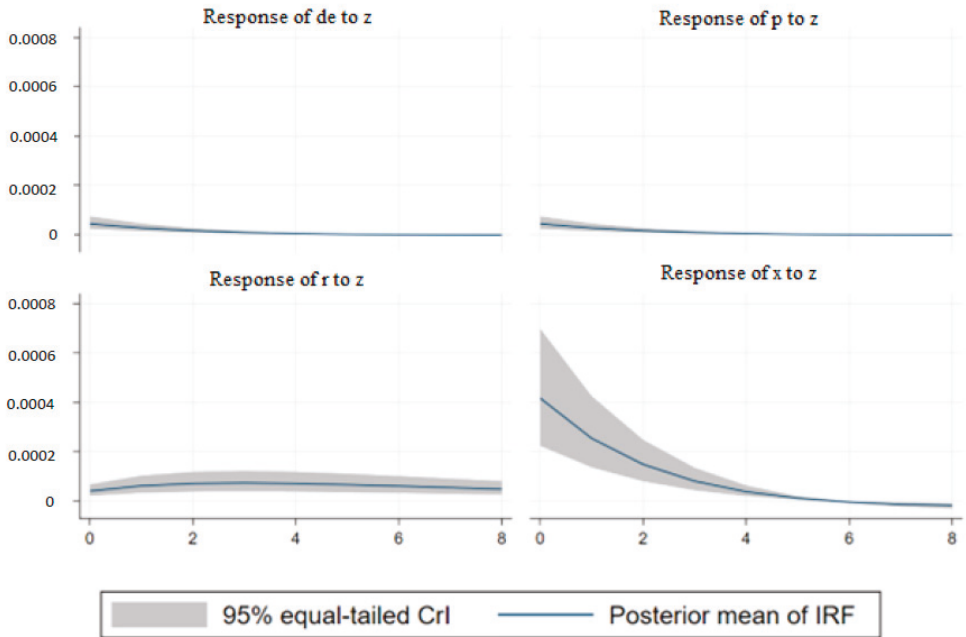


Figure 7. Response of Vietnam’s output gap, refinancing interest rate, inflation, and exchange rate changes to technology change shock.

The specific arithmetical responses of Vietnam’s output gap and inflation to the probability shocks of the COVID-19 outbreak, monetary policy, and technological changes are shown in Table 6.

**Table 6.** The response of Vietnam’s output gap and refinancing interest rate to the shocks of the COVID-19 outbreak, changes in monetary policy, and changes in technology.

Impulse	Response		x			r		
	Step	irf	Lower	Upper	irf	Lower	Upper	
COVID	0	−0.9400	−0.9506	−0.9291	−0.0889	−0.0895	−0.0883	
	1	0.3637	0.3508	0.3773	−0.0470	−0.0486	−0.0455	
	2	0.1028	0.0911	0.1136	−0.0333	−0.0340	−0.0328	
	3	0.0892	0.0872	0.0914	−0.0221	−0.0227	−0.0216	
	4	0.0569	0.0542	0.0595	−0.0149	−0.0152	−0.0145	
	5	0.0386	0.0370	0.0402	−0.0100	−0.0102	−0.0097	
	6	0.0259	0.0246	0.0270	−0.0067	−0.0069	−0.0065	
	7	0.0174	0.0165	0.0181	−0.0045	−0.0046	−0.0044	
r	8	0.0116	0.0111	0.0122	−0.0030	−0.0031	−0.0029	
	0	−3.1536	−3.1869	−3.1132	1.1235	1.1227	1.1243	
	1	−1.8372	−1.8595	−1.8088	0.3708	0.3656	0.3754	
	2	−1.3278	−1.3468	−1.3040	0.3794	0.3779	0.3810	
	3	−0.8585	−0.8713	−0.8421	0.2100	0.2088	0.2111	
	4	−0.5871	−0.5971	−0.5744	0.1561	0.1552	0.1571	
	5	−0.3901	−0.3974	−0.3811	0.0996	0.0991	0.1003	
	6	−0.2631	−0.2685	−0.2564	0.0686	0.0680	0.0692	
z	7	−0.1761	−0.1800	−0.1713	0.0454	0.0450	0.0459	
	8	−0.1183	−0.1211	−0.1148	0.0307	0.0303	0.0311	
	0	0.0004	0.0002	0.0007	0.0000	0.0000	0.0001	
	1	0.0003	0.0001	0.0004	0.0001	0.0000	0.0001	
	2	0.0001	0.0001	0.0002	0.0001	0.0000	0.0001	
	3	0.0001	0.0000	0.0001	0.0001	0.0000	0.0001	
	4	0.0000	0.0000	0.0001	0.0001	0.0000	0.0001	
	5	0.0000	0.0000	0.0000	0.0001	0.0000	0.0001	
6	0.0000	0.0000	0.0000	0.0001	0.0000	0.0001		
7	0.0000	0.0000	0.0000	0.0001	0.0000	0.0001		
8	0.0000	0.0000	0.0000	0.0000	0.0000	0.0001		

**5. Conclusions and Recommendations**

With the analysis from the DSGE model, combined with the epidemic situation and information on the macro indicators on monetary policy implementation of the State Bank of Vietnam in 2020, we can see that the analysis results from the DSGE model are quite consistent with the real situation, and there is strong empirical evidence that the effectiveness of the SBV’s monetary policy implementation in the past has adapted to the new normal. From a review of previous studies, combined with analysis of model results and the current situation, some recommendations are made for the State Bank of Vietnam as follows:

*First*, the results have shown a shock of one standard deviation increase (about 1.49% increase in the probability of a COVID-19 outbreak) to the state variable COVID-19 im-

mediately reduces the output gap by 0.94%. Moreover, refinancing interest rate, inflation, and exchange rate changes also have an immediate decline in response to this shock, but the magnitude of the reduction is relatively small. It is clear that policymakers have learnt a lot from past crises. Therefore, the administration of monetary policy has been more cautious in reducing interest rates. In the near future, policymakers must study the impact of the pandemic on the economy in order to have timely supportive policies that ensure the economy's safety and not lead to high inflation.

*Second*, an increase in the refinancing interest rate leads to a sharp decrease in the output gap, about 3.15%, and a slight decrease in inflation, about 0.3%. This result also shows that inflation seems to be less sensitive to the policy interest rate. Moreover, empirical studies on the impact of the COVID-19 epidemic all show that unconventional monetary policy tools can be effective promptly, so these tools should be considered more by the State Bank of Vietnam.

*Third*, in the long run, measures to reduce interest rates and support credit may lead to a local excess of capital in some areas, without flowing into the production sector, possibly causing further economic consequences, such as inflationary pressure and asset bubbles, etc.

Therefore, in addition to the monetary policy tools being implemented, the inspection and supervision of managers also need to be regular and continuous, creating a synchronous macro support system, in coordination with other macro policies of the government that are harmonized, aiming at stabilizing and recovering the economy.

**Author Contributions:** Conceptualization, T.D.N.; methodology, A.H.L. and L.K.T.; software, A.H.L. and E.I.T.; validation, L.K.T.; formal analysis, T.D.N.; investigation, T.D.N.; resources, A.H.L.; data curation, A.H.L.; writing—original draft preparation, T.D.N., A.H.L. and L.K.T.; writing—review and editing, L.K.T. and E.I.T.; visualization, A.H.L.; supervision, T.D.N. All authors have read and agreed to the published version of the manuscript.

**Funding:** This research is funded by Ho Chi Minh University of Banking under grant number 01/HĐ-KHCN-NCM.

**Institutional Review Board Statement:** Not applicable.

**Informed Consent Statement:** Not applicable.

**Data Availability Statement:** Data should be accessed from the authors in request at anhhlh\_vnc@buh.edu.vn.

**Conflicts of Interest:** The authors declare no conflict of interest.

## Notes

- <sup>1</sup> New Keynesian Dynamic Stochastic General Equilibrium model.
- <sup>2</sup> Core personal consumption expenditures (PCE) price inflation.
- <sup>3</sup> Effective funds rate.
- <sup>4</sup> According to Friedman, a model is applicable even if the assumptions of the model do not necessarily reflect reality. A model is a representation of a concept that reflects some aspect of reality. The variables in the model can be a connected set of some representative data, whereby the model results can be used to predict, or the model can produce a prediction that we can test. So the model is like a tool; we can use it and, if it works, it is useful. We cannot have a precise set of assumptions about the behavior of economic agents.
- <sup>5</sup> The report was made part of a collaborative research project between scientists from the National Economics University and Japan International Cooperation Agency experts.

## References

- Aguilar, Pablo, Óscar Arce, Samuel Hurtado, Jaime Martínez-Martin, Galo Nuño Barrau, and Carlos Thomas. 2020. *The ECB Monetary Policy Response to the Covid-19 Crisis*. Occasional Paper 2026. Madrid: Banco de España. Available online: <https://econpapers.repec.org/paper/bdeopaper/2026e.htm> (accessed on 1 January 2022).
- Aizenman, Joshua, Yothin Jinjark, and Mark M. Spiegel. 2022. *Fiscal Stimulus and Commercial Bank Lending Under COVID-19*. Working Paper. Working Paper Series. Cambridge: National Bureau of Economic Research. [[CrossRef](#)]

- Baker, Scott R., Nicholas Bloom, Steven J. Davis, and Stephen J. Terry. 2020. *COVID-Induced Economic Uncertainty*. Working Paper Series. Cambridge: National Bureau of Economic Research. [CrossRef]
- Bartik, Alexander W., Marianne Bertrand, Zoë B. Cullen, Edward L. Glaeser, Michael Luca, and Christopher T. Stanton. 2020. *How Are Small Businesses Adjusting to COVID-19? Early Evidence from a Survey*. Working Paper Series. Cambridge: National Bureau of Economic Research. [CrossRef]
- Bhar, Ramaprasad, and Anastasios George Malliaris. 2021. Modeling U.S. Monetary Policy during the Global Financial Crisis and Lessons for Covid-19. *Journal of Policy Modeling* 43: 15–33. [CrossRef] [PubMed]
- Bui Duy Hung. 2020. Monetary Policy in the Context of Covid-19 in Some Developed Countries and Vietnam. *Banking Magazine* 16: 50–54.
- Campello, Murillo, Gaurav Kankanhalli, and Pradeep Muthukrishnan. 2020. *Corporate Hiring under COVID-19: Labor Market Concentration, Downskilling, and Income Inequality*. Working Paper Series; Cambridge: National Bureau of Economic Research. [CrossRef]
- Coibion, Olivier, Yuriy Gorodnichenko, and Michael Weber. 2020. *The Cost of the Covid-19 Crisis: Lockdowns, Macroeconomic Expectations, and Consumer Spending*. Working Paper Series; Cambridge: National Bureau of Economic Research. [CrossRef]
- Cortes, Gustavo S., George P. Gao, Felipe B. G. Silva, and Zhaogang Song. 2022. Unconventional Monetary Policy and Disaster Risk: Evidence from the Subprime and COVID-19 Crises. *Journal of International Money and Finance* 122: 102543. [CrossRef] [PubMed]
- Cúrdia, Vasco. 2020. Mitigating COVID-19 Effects with Conventional Monetary Policy. *FRBSF Economic Letter* 9: 1–5. Available online: <https://econpapers.repec.org/article/fipfedfel/87776.htm> (accessed on 1 January 2022).
- Ding, Wenzhi, Ross Levine, Chen Lin, and Wensi Xie. 2021. Corporate Immunity to the COVID-19 Pandemic. *Journal of Financial Economics* 141: 802–30. [CrossRef] [PubMed]
- Dorđević, Marina, Jadranka Todorović, and Milica Ristic. 2020. Application of unconventional monetary policy instruments in mitigation of the economic consequences of the COVID 19 virus pandemic. *Facta Universitatis, Series: Economics and Organization* 17: 231–48. [CrossRef]
- Eichenbaum, Martin S., Sergio Rebelo, and Mathias Trabandt. 2022. Epidemics in the New Keynesian Model. *Journal of Economic Dynamics and Control* 140: 104334. [CrossRef]
- Eichenbaum, Martin, Sergio Rebelo, and Mathias Trabandt. 2021. The Macroeconomics of Epidemics. *Review of Financial Studies* 34: 5149–87. Available online: [https://econpapers.repec.org/article/ouprfnst/v\\_3a34\\_3ay\\_3a2021\\_3ai\\_3a11\\_3ap\\_3a5149-5187..htm](https://econpapers.repec.org/article/ouprfnst/v_3a34_3ay_3a2021_3ai_3a11_3ap_3a5149-5187..htm) (accessed on 1 January 2022). [CrossRef]
- Forsythe, Eliza, Lisa B. Kahn, Fabian Lange, and David Wiczer. 2020. Labor Demand in the Time of COVID-19: Evidence from Vacancy Postings and UI Claims. *Journal of Public Economics* 189: 104238. [CrossRef] [PubMed]
- Friedman, Milton. 1968. The Role of Monetary Policy. *The American Economic Review* 58: 1–17. Available online: <https://www.jstor.org/stable/1831652> (accessed on 1 January 2022).
- Malata, Alain K., and Christian Pinshi. 2020. Fading the Effects of Coronavirus with Monetary Policy. Available online: <https://hal.archives-ouvertes.fr/hal-02889520> (accessed on 1 January 2022).
- NEU-JICA. 2020. *Evaluation of Covid-19 Response Policies and Recommendations*. Hanoi: National Economics University Publishing House.
- Nguyen Minh Cuong. 2021. Monetary Policy in Post-Covid-19 Economic Recovery and Growth. *Banking Magazine* 3+4: 23–24.
- Pham Thanh Ha. 2021a. Coordination of Fiscal and Monetary Policy: Achievements in 2020 and Orientation for 2021. *Financial Review* 2021: 27–31.
- Pham Thanh Ha. 2021b. Operating Monetary Policy to Support the Economy against the Covid-19 Pandemic and Orientation for 2021. *Banking Review* 6: 12–16.
- Pinshi, Christian P. 2020. *COVID-19 Uncertainty and Monetary Policy*. 100184. MPRA Paper. München: University Library of Munich, Available online: <https://ideas.repec.org/p/pramprapa/100184.html> (accessed on 1 January 2022).
- SBV. 2020. Speech of Deputy Governor Dao Minh Tu at the Conference on Implementing Tasks of the Banking Industry in 2021. Available online: [https://www.sbv.gov.vn/webcenter/portal/vi/menu/rm/cbpbclndhnn/cbpbclndhnn\\_chitiet;jsessionid=O\\_VBmLLUdLuamr5PdCQFMrdzdzmtyeK2ABAILDH39jqzjCKNe-jY!527291070!-1636100262?centerWidth=80%25&dDocName=SBV426430&leftWidth=20%25&rightWidth=0%25&showFooter=false&showHeader=false&\\_adf.ctrl-state=s041a7t9x\\_498&\\_afLoop=22234595784642297#%40%3F\\_afLoop%3D22234595784642297%26centerWidth%3D80%2525%26dDocName%3DSBV426430%26leftWidth%3D20%2525%26rightWidth%3D0%2525%26showFooter%3Dfalse%26showHeader%3Dfalse%26\\_adf.ctrl-state%3D10ycmrfq6k\\_4](https://www.sbv.gov.vn/webcenter/portal/vi/menu/rm/cbpbclndhnn/cbpbclndhnn_chitiet;jsessionid=O_VBmLLUdLuamr5PdCQFMrdzdzmtyeK2ABAILDH39jqzjCKNe-jY!527291070!-1636100262?centerWidth=80%25&dDocName=SBV426430&leftWidth=20%25&rightWidth=0%25&showFooter=false&showHeader=false&_adf.ctrl-state=s041a7t9x_498&_afLoop=22234595784642297#%40%3F_afLoop%3D22234595784642297%26centerWidth%3D80%2525%26dDocName%3DSBV426430%26leftWidth%3D20%2525%26rightWidth%3D0%2525%26showFooter%3Dfalse%26showHeader%3Dfalse%26_adf.ctrl-state%3D10ycmrfq6k_4) (accessed on 1 January 2022).
- Taylor, John Brian. 2000. *Using Monetary Policy Rules in Emerging Market Economies*. Working Paper. Stanford: Stanford University.
- Zhang, Xiping, Yimeng Zhang, and Yunchan Zhu. 2021. COVID-19 Pandemic, Sustainability of Macroeconomy, and Choice of Monetary Policy Targets: A NK-DSGE Analysis Based on China. *Sustainability* 13: 3362. [CrossRef]
- Zheng, Tingguo, and Huiming Guo. 2013. Estimating a Small Open Economy DSGE Model with Indeterminacy: Evidence from China. *Economic Modelling* 31: 642–52. [CrossRef]



## Article

# The Tourist and Recreational Potential of Cross-Border Regions of Russia and Kazakhstan during the COVID-19 Pandemic: Estimation of the Current State and Possible Risks

Anna Tanina <sup>1</sup>, Larissa Tashenova <sup>2,\*</sup>, Yevgeni Konyshv <sup>3</sup>, Dinara Mamrayeva <sup>2</sup> and Dmitriy Rodionov <sup>4</sup>

- <sup>1</sup> Institute of Industrial Management, Economics and Trade, Graduate School of Public Administration, Peter the Great St. Petersburg Polytechnic University (SPbPU), 194021 St. Petersburg, Russia
- <sup>2</sup> Faculty of Economics, Marketing Department, Karaganda Buketov University, Karaganda 100000, Kazakhstan
- <sup>3</sup> Geography Faculty, Socio-Economic Geography Department, Perm State National Research University, 614990 Perm, Russia
- <sup>4</sup> Institute of Industrial Management, Economics and Trade, Graduate School of Industrial Economics, Peter the Great St. Petersburg Polytechnic University (SPbPU), 194021 St. Petersburg, Russia
- \* Correspondence: larissatashenova1988@gmail.com; Tel.: +77-015120348

**Abstract:** The development of tourism is associated with numerous risks that have a direct and indirect impact on the realization of tourist and recreational potential. In recent years, in addition to internal risks, the importance of external environmental risks (geopolitical and epidemiological) has increased. The COVID-19 pandemic is one of the foremost of these risks, and its effects on the development of regional tourism demands attention. The purpose of the study is to estimate the level of tourist and recreational potential of cross-border regions of the Russian Federation and Kazakhstan, and the possible risks during the COVID-19 pandemic. After the breakup of the USSR, one of the longest land borders in the world was established between Russia and Kazakhstan. The geographical scope of the study includes 12 constituent entities of the Russian Federation and 7 regions of Kazakhstan. Information posted on statistical portals, data from geographical atlases, and specialized websites of the executive authorities were used as the materials for the study. The tourist and recreational potential of the regions of the Russian Federation and Kazakhstan was estimated by the scorecard method, with the assignment of weight coefficients to indicators included in four main clusters: Natural Factors, Cultural and Historical Factors, Social and Economic Factors, and Infrastructure Support of Tourism. Additionally, the experience of studying risks associated with tourism development during the pandemic was summarized. The conclusions reached are indicative of different levels of tourism and recreational potential in cross-border regions of the Russian Federation and Kazakhstan, and the inconsistency of the industry's structure. It was found that the COVID-19 pandemic had increased the number of risks for the realization of tourism and recreational potential, which must be taken into account when making management decisions. The authorities of cross-border regions can use the results of the research to adjust tourism policy under the current restrictions and increased global risks. The application of mechanisms and methods of territorial planning and management will depend on the level of tourism and recreational potential. For regions with high and above-average potential, the emphasis should be on participation in federal projects, the development of cluster initiatives, and the application of a diversification strategy. Regions with medium and low potential should focus on the domestic tourist flow, develop inter-regional cooperation, and focus on the strategy of gaining a competitive advantage.

**Keywords:** tourist and recreational potential; border areas; tourism; state support measures; COVID-19 pandemic

**Citation:** Tanina, Anna, Larissa Tashenova, Yevgeni Konyshv, Dinara Mamrayeva, and Dmitriy Rodionov. 2022. The Tourist and Recreational Potential of Cross-Border Regions of Russia and Kazakhstan during the COVID-19 Pandemic: Estimation of the Current State and Possible Risks. *Economics* 10: 201. <https://doi.org/10.3390/economics10080201>

Academic Editor: Robert Czudaj

Received: 30 June 2022

Accepted: 15 August 2022

Published: 18 August 2022

**Publisher's Note:** MDPI stays neutral with regard to jurisdictional claims in published maps and institutional affiliations.



**Copyright:** © 2022 by the authors. Licensee MDPI, Basel, Switzerland. This article is an open access article distributed under the terms and conditions of the Creative Commons Attribution (CC BY) license (<https://creativecommons.org/licenses/by/4.0/>).



## 1. Introduction

Many factors affect tourism development in the cross-border region of Russia and Kazakhstan (Mamraeva and Tashenova 2020). The fundamental condition for attracting tourists is the existing tourist potential of the territory. National and local authorities significantly affect the success of territorial tourism resource use. Tourism development in transboundary regions has positive and negative features: the attraction of tourists from neighboring countries, opportunities to sell tourist products in the international and domestic markets, and the need to form an information infrastructure, so it is important to consider that the type of borders may change. For example, because of the USSR's collapse in 1991, the regional borders between republics became national borders. This study considers the advantages of tourism industry development in the context of preserved ties between the authorities and the populations of cross-border regions. Russian tourists are also attracted by the fact that most of Kazakhstan's population speaks Russian.

The authors used modeling to study the region's potential tourism implementation to increase the certainty of actions (including by public authorities) (Ivanova et al. 2020; Volodin et al. 2019). In addition, the authors used various model types to assess the parameters of enterprises and to study the peculiarities of the development of different industries and individual economic processes (Rodionov et al. 2020; Boldyrev et al. 2019; Aletdinova and Bakaev 2019; Chernogorskiy et al. 2018). The use of modeling is necessary for forecasting crisis conditions (Borovkov et al. 2020; Toroptsev et al. 2019). Authors usually use models in the study of tourism types (Tanina et al. 2020) and tourism potential of a territory (Mamraeva and Tashenova 2020).

The activities of tourism organizations and developers in a territory are significantly affected by diverse types of risks. In addition to internal risks related to the activities of an enterprise or industry itself, the development of globalization has increased external risks to the environment, also affecting tourism (Nikolova et al. 2017; Lee et al. 2021a; Istiak 2021; Dimopoulos et al. 2021; Vidishcheva et al. 2020; Sikarwar 2021; Pérez-Rodríguez and Santana-Gallego 2020). The COVID-19 pandemic has proved that the impact of epidemiological risks at the global, national, and regional levels was previously underestimated. The pandemic has affected many economic indicators, including investment in certain regions and their attractiveness as tourist destinations (Rodionov et al. 2021). In fact, tourism has become one of the most affected industries.

*This paper aims to assess the current tourism and recreational potential (TRP) of the cross-border regions of Russia and Kazakhstan, and the risks these regions faced during the COVID-19 pandemic. We will complete the following tasks: determine the value of TRP in the cross-border areas of Russia and Kazakhstan, construct a multilayer map based on the assessment results, and identify and analyze the risks of tourism development in the territories considered in the paper.*

## 2. Literature Review

In this study, the authors considered the specific impact of the COVID-19 pandemic on tourism in the cross-border regions of Kazakhstan and Russia. Studies of organizations operating in boundary zones are relatively rare (Shneider et al. 2020; Leukhina et al. 2020).

Cross-border tourism has the following features:

- Forms a necessary part of the process of achieving sustainable development goals in the EU Cross-Border Cooperation (CBC) model;
- Contributes to the implementation of sustainable development goals to a greater extent than national tourism programs, which should be considered in the development of a destination;
- Requires integrated management because cross-border regions have a more complex structure;
- Has the ability to implement joint marketing strategies to increase tourist flow;
- Primarily performs the integrative function of cultural tourism;
- Includes unique types of tourism, such as smuggling tourism;

- Has different degrees of tourist flow penetration into internal territories;
- Should be ready to reorient activities to the domestic market in situations of significant reduction in tourist flow from abroad;
- Has faster recovery time in the post-pandemic era than other tourism sectors.

Currently, there are few studies based on the use of simulation to estimate the impact of the pandemic on tourism in terms of the realization of an area's tourism potential. Most of the published works concern risk perception, changes in the behavior of tourists, or the impact of the COVID-19 pandemic on the tourism industry of a particular area. Among the studies, the following models can be noted: collective risk (Chica et al. 2021), estimation of risks and vulnerability of the economy during COVID-19 (Arbulú et al. 2021), perception of health risks in tourism (Godovykh et al. 2021), perception of the COVID-19 risk when visiting national parks (Park et al. 2022), the relations between perceived risk and willingness to pay for additional safety measures due to the COVID-19 pandemic (Sánchez-Cañizares et al. 2021), the impact of COVID-19 on tourist behavior (Xu et al. 2021), predictors of perceived travel risks (Teeroovengadum et al. 2021), dependence of a company's value on information about the need for social distancing in the hospitality and tourism industry (Im et al. 2021), and changes in risk perception after the COVID-19 pandemic (Chan 2021).

Restrictions imposed due to a need to ensure further travel safety have raised the risks for tourism (Rudyanto et al. 2021; Ruiz-Sancho et al. 2021; Matiza and Slabbert 2022; Tseng et al. 2021; Cheng et al. 2022; Lee et al. 2021a; Lapko et al. 2021; Rather 2021). The tourist flow to almost all countries and regions has decreased, especially in areas with insufficiently realized tourism potential (Lee et al. 2021a; Wu 2021; Shahzad et al. 2022). However, in some areas, tourist flow has decreased to a lesser degree due to the influx of domestic tourists (Joo et al. 2021; Matiza and Slabbert 2022; Zhu and Deng 2020; Wang et al. 2021). That said, it is necessary to consider the behavior of local residents, who fear an increased risk of COVID-19 infection when tourists visit their destinations (Woosnam et al. 2021). The studies conducted show that the impact of the pandemic on tourism has been more destructive than that of previous, mainly economic, crises (Škare et al. 2021). To ensure the realization of the tourist potential of an area, state authorities need to take significant measures to increase tourist flows and to ensure the financial stability of tourism organizations (Villacé-Molinero et al. 2021; Grech et al. 2020; Chan 2021).

### 3. Materials and Methods

The methodology for estimating the tourism and recreational potential of the areas of the Republic of Kazakhstan (RK) and the Russian Federation (RF) includes 9 key stages:

#### 1. Identification of clusters and estimation indicators.

- Cluster 1—Natural Factors (11): average temperature in January, °C; average temperature in July, °C; average annual precipitation, mm; period of seasonal snow cover, days; absolute elevation of terrain relief, m; number of lakes (large, more than 100 sq. km), units; number of rivers (large, over 500 km), units; number of protected areas, units; number of protected plant species, units; number of protected animal species, units; number of natural monuments (of republican significance), units.
- Cluster 2—Cultural and Historical Factors (11): number of historical and cultural monuments (of republican significance), units; number of archaeological monuments (of republican significance), units; number of monuments of urban planning and architecture (of republican significance), units; number of museums, units; number of theaters, units; number of zoos (including petting zoos), units; number of concert organizations, units; number of circuses, units; number of libraries, units; number of movie theaters, units (including those with 2–7 screens); number of entertainment and recreational parks, units.
- Cluster 3—Social and Economic Factors (4): consumer product retail chains, quantity; number of trade markets, units; density of railway tracks, km per 1000 sq. km; length of public hard-surfaced motor roads, km.

- Cluster 4—Infrastructure Support of Tourism (10): number of exercise and sports facilities (including number of ski resorts, rowing clubs, sports arenas, etc.), units; number of primary wellness tourism facilities (sanatorium-and-spa resorts, specialized medical centers, etc.), units; number of five-star hotels, units; number of four-star hotels, units; number of three-star hotels, units; number of accommodations without category, as well as one- and two-star hotels, units; hotel room capacity, units; number of airports, units; number of tourism firms and tour operators, units; headcount of workers in the tourism sector, in thousands.

It should be noted that when calculating the TRP of RF regions bordering the Republic of Kazakhstan, an indicator such as ‘Number of Monuments of Urban Planning and Architecture (of republican significance), units,’ has not been used, because since 2013, they have not been accounted for under this approach; these sites are considered in the category ‘Cultural Heritage Sites.’ It should also be noted that the values for the parameter ‘Number of Zoos’ have been used without taking petting zoos into account.

**2. Correlation of weight coefficients with TRP estimation indicators** obtained on the basis of an expert estimation conducted by the authors (Mamraeva and Tashenova 2020) when developing the basic methodology underlying this paper. Experts in tourism and recreational geography, representatives of the tourism services market (travel agents and tour operators), and officials from government agencies served as experts. The parameters were estimated using a 5-point scale, where 1 was the minimum and 5 was the maximum score.

**3. Calculation of the average country value (ACV) for each indicator**, with the exception of the average temperature in January, the average temperature in July, the average annual precipitation, the period of seasonal snow cover, and the absolute elevation of the terrain relief.

**4. Attainment of relative values by dividing the indicator’s initial value in the context of previously identified clusters by ACV.**

**5. Assignment of 0.1 and 2 to the obtained relative value based on the TRP estimation indicator system (Tourist and Recreation Potential) estimation indicators (Table 1).**

Table 1. System of TRP Area Estimation Indicators \*.

Indicator Name	Scores			Weight Coefficient **
	0	1	2	
Average temperature in January, °C	0–(–8) and (–25)	(–19)–(–14)	(–9)–(–18)	0.06
Average temperature in July, °C	11–15	16–19	20–25	0.06
Average annual precipitation, mm	600–800	400–600	300–400	0.05
Period of seasonal snow cover, days	0–140	140–160	More than 160	0.07
Absolute elevation of the terrain relief, m	0–500	500–1000	More than 1000	0.12
Number of lakes (large, more than 100 sq. km), units	No	1.3≤	More than 1.3	0.12
Number of rivers (large, more than 500 km), units	No	1.2≤	More than 1.2	0.12
Number of SPNRs (Specially Protected Natural Reservations), units	No	1.4≤	More than 1.4	0.13
Number of protected plant species, units	No	1.0≤	More than 1.0	0.06
Number of protected animal species, units	No	1.4≤	More than 1.4	0.08
Number of natural monuments (of republican significance), units	No	1.4≤	More than 1.4	0.14

Table 1. Cont.

	Indicator Name	Scores			Weight Coefficient **
		0	1	2	
<b>CHF (Cultural and Historical Factors)</b>	Number of historical and cultural monuments (of republican (federal) significance), units	No	2.0≤	More than 2.0	0.13
	Number of archaeological monuments (of republican (federal) significance), units	No	2.0≤	More than 2.0	0.13
	Number of monuments of urban planning and architecture (of republican (federal) significance), units	No	1.5≤	More than 1.5	0.12
	Number of museums, units	No	1.8≤	More than 1.8	0.12
	Number of theaters, units	No	1.7≤	More than 1.7	0.08
	Number of zoos (including petting zoos), units	No	1.5≤	More than 1.5	0.08
	Number of concert organizations, units	No	1.4≤	More than 1.4	0.06
	Number of circuses, units	No	1.4≤	More than 1.4	0.08
	Number of libraries, units	No	1.0≤	More than 1.0	0.03
	Number of movie theaters, units (including those with 2–7 screens)	No	1.2≤	More than 1.2	0.05
Number of entertainment and recreation parks, units	No	1.8≤	More than 1.8	0.12	
<b>SEF (Social and Economic Factors)</b>	Consumer product retail chains, quantity	No	1.2≤	More than 1.2	0.17
	Number of trade markets, units	No	1.1≤	More than 1.1	0.16
	Density of railway tracks, km per 1000 sq. km	No	1.6≤	More than 1.6	0.33
	Length of public hard-surfaced motor roads, km	No	1.7≤	More than 1.7	0.34
<b>IST (Infrastructure Support of Tourism)</b>	Number of physical culture and sports facilities (including: number of ski resorts, rowing clubs, sports arenas, etc.), units	No	2.0≤	More than 2.0	0.13
	Number of primary wellness tourism facilities—sanatorium-and-spa resorts, specialized medical centers, etc.	No	1.9≤	More than 1.9	0.13
	Number of 5-star hotels, units	No	1.1≤	More than 1.1	0.09
	Number of 4-star hotels, units	No	1.1≤	More than 1.1	0.08
	Number of 3-star hotels, units	No	1.6≤	More than 1.6	0.12
	Number of accommodations w/o category, as well as 1- and 2-star hotels, units	No	1.4≤	More than 1.4	0.09
	Hotel room capacity, units	No	1.8≤	More than 1.8	0.09
	Number of airports, units	No	1.8≤	More than 1.8	0.11
	Number of tourist companies and tour operators, units	No	1.7≤	More than 1.7	0.09
	Headcount of workers in the tourism sector, in thousands	No	1.6≤	More than 1.6	0.06

\* Note—compiled by the authors based on the method of estimating TRP of the areas by D.A. Dirina, E.P. Krupochkina, and E. I. Golyadkina. \*\* Weight coefficients are calculated based on expert estimations.

**6. Multiplication of the obtained values by weight coefficients for each selected parameter of TRP estimation in the context of clusters.**

**7. Attainment of average values for each cluster in the context of regions based on the arithmetic mean.**

8. Attainment of the final integral estimation for each region.

9. Calculation of the final integral estimation.

In general, the entire methodology can be graphically represented as follows (Figure 1):

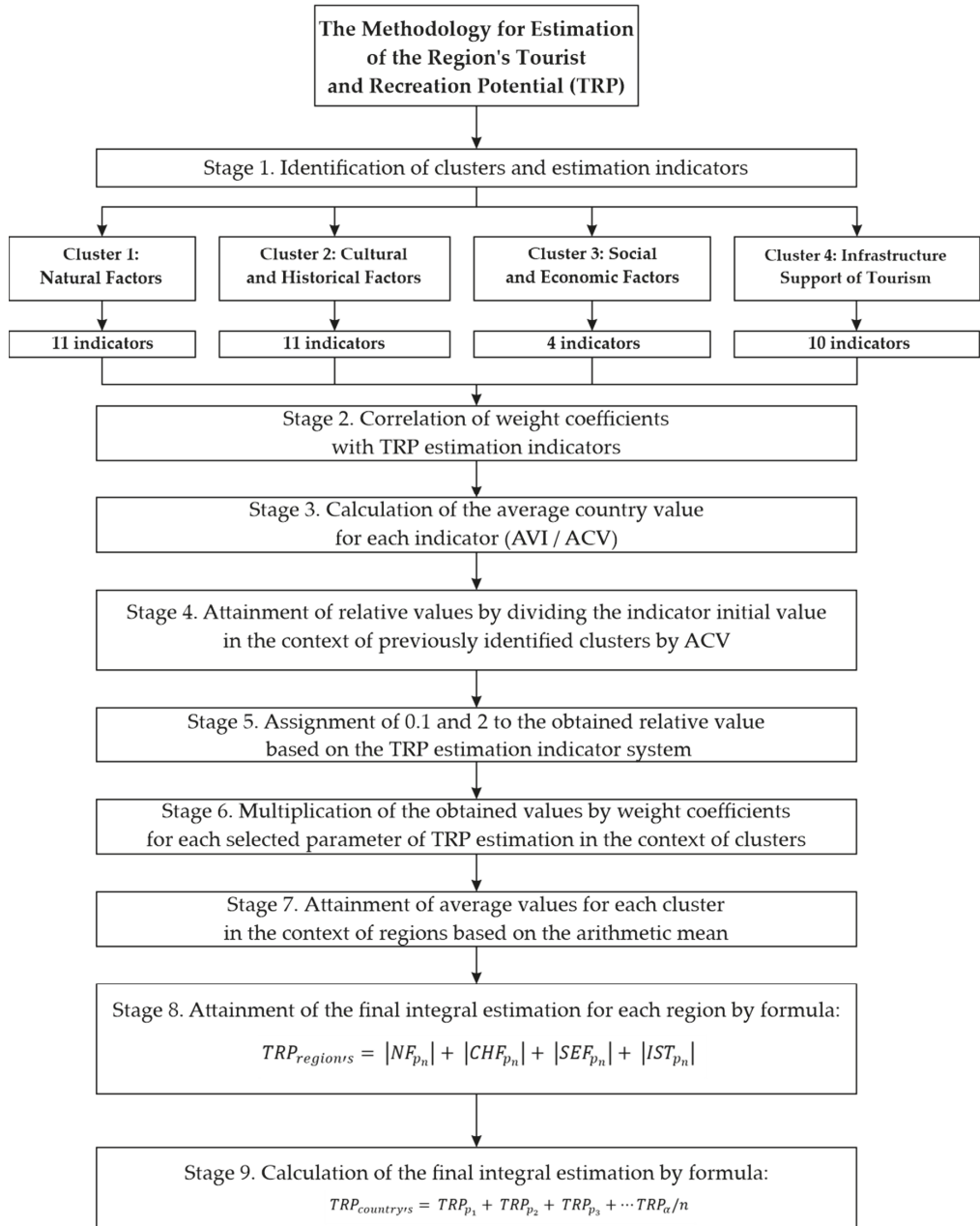


Figure 1. Methodology for Estimating the Regions' TRP. Note—compiled by the authors.

The results of the regions' potential tourism and recreational estimates are presented in a thematic cartogram. The cartogram shows the spatial distribution of territorial entities in Russia and Kazakhstan by volume of tourism and recreational potential. To create it, a specialized cartographic program—Q-GIS—was used. The Russia and Kazakhstan shp files served as a cartographic basis, and the EPSG:5940 projection was used. The results of the tourism and recreational potential estimation were converted from the xsl format to csv, which allowed them to be bound to spatial data from the shp file. Subsequently, the data analysis tool, as well as the style tool, was used to perform the zoning procedure with dasymetric differentiation. Elements of cartographic semiotics have been added to the resulting cartoid: a scale ruler, explanatory notes, and a schematic compass.

#### 4. Results

The following regions of the RF border with Kazakhstan were included in the study: Astrakhan, Volgograd, Saratov, Samara, Orenburg, Chelyabinsk, Kurgan, Tyumen, Omsk, and the Novosibirsk Regions, as well as the Altai Territory and the Republic of Altai.

Table 2 gives a brief description of the regions in terms of tourist attractiveness according to Russia Travel, a national tourist portal.

**Table 2.** Brief description of the RF's regions in terms of tourism attractiveness.

Region	Brief Description
<b>Astrakhan Region</b>	This is a region with an ancient history, the center of many events reflected in the chronicles of Russia. The land is distinguished by its rich natural diversity, unique ethnic makeup, and cultural potential accumulated over centuries. The region's main city—Astrakhan—proudly bears the titles of Caspian Capital, Keeper of Living History, and Precious Pearl of the Lower Volga Region.
<b>Volgograd Region</b>	This is a land of natural beauty and national traditions. It is the homeland of Ataman Ermak Timofeevich, the conqueror of Siberia, and the popular rebels Stepan Razin and Kondraty Bulavin. It is a cradle of victory in the Great Patriotic War that preserves the memory of the fallen heroes in a mass grave on Mamayev Hill (Mamayev Kurgan). This is an area of archaeological monuments, including an ancient human encampment, Sarmatian villages, Savromat burial grounds, and Golden Horde cities.
<b>Saratov Region</b>	This region is the place of the first landing by cosmonaut Yuri Gagarin. Here, in a moderate continental steppe climate on the banks of the Volga River, Saratov has been standing for more than 400 years. Once a major merchant center in the country, today it is a city of a dozen museums. In the cultural capital of the Volga Region, one can see a unique collection of paintings, including canvases by Aivazovsky and Petrov-Vodkin, or a collection of samovars. Outside the regional capital is the House with a Lion—a unique open-air museum of ancient house paintings and thermal pools.
<b>Samara Region</b>	This region is located in the middle reaches of the Volga River. The regional capital boasts the longest river embankment in Russia and the tallest railway station building in Europe. Samara is also famous for producing the most popular beer in the country. The surrounding landscapes and the local way of life have inspired many famous Russian artists. One of the most picturesque and mystical places of the Samara region is the river bend, Samarskaya Luka. Here, one can see beavers, wild boar, elk, and foxes.
<b>Orenburg Region</b>	This region is located in the very south of Russia, near the border with Kazakhstan. Its outline on the map resembles a flying dragon. The Orenburg region is a land of endless steppes. Here, one can experience a true winter and legendary Russian frost, but travelers will not freeze in these lands: the Orenburg down shawl, a traditional souvenir of the region, will protect them from the cold.

Table 2. Cont.

Region	Brief Description
<b>Chelyabinsk Region</b>	The locals like saying that the Chelyabinsk region is caressed by both subterranean and celestial deities. The famous Ural gems are mined in this region: underground treasures surrounded by fairy tales with which the entire population of the country is brought up. Most recently, in the capital of the region, hundreds of city cameras recorded the fall of a meteorite, which can now be seen in a museum. In addition to gems, there are modern ski resorts and national parks in the mountains of the Southern Urals.
<b>Kurgan Region</b>	This region is called the gateway of Siberia. The Baikal Federal Highway passes through its territory, as does the Trans-Siberian Railway. People come here for walking and educational, cycling, equestrian, automobile, snowmobile, and ski tourism. The Kurgan territory boasts more than a thousand sites included in the list of cultural and historical heritage of the RF.
<b>Tyumen Region</b>	This region is located in the southwestern part of the West Siberian Plain. It is where explorers started discovering new territories in the 16th century and where many travelers start getting acquainted with Siberia today. The only stone Kremlin in Siberia is located in Tobolsk. The region's wooden architectural monuments are diverse—here, one can see the Baroque embodied in wood. Additional artifacts in the region include dinosaur skeletons and ancient human encampments.
<b>Omsk Region</b>	There are more than twenty hunting reserves in the territory of the Omsk region; this is a real paradise for fans of hunting and fishing. Devotees of history will be interested in ancient encampments and settlements, burial mounds, and iconic monuments. Historical sites include Chudskaya Gora, Batakovo Tract, and the mysterious energy village of Okunevo, with its system of five lakes, one of which is fictional.
<b>Novosibirsk Region</b>	The third largest city in Russia, Novosibirsk, is not a tourist center; as a rule, people come here on business. Nevertheless, the city, just like the region, has something to show its guests: the largest zoo in Russia, the scientific center of Akademgorodok (science campus), and a large number of museums and theaters. Ski resorts, Zveroboy Rocks, Barsukov Cave, Karachi Lake, nature reserves, and pine forests are great places for sports, walks, nature observations, and picking mushrooms and berries.
<b>The Republic of Altai</b>	This is a land of mountains, the highest ridges in Siberia, separated by deep river valleys. It is also a land of unique natural areas, many of which are UNESCO World Heritage sites. The magnificent landscapes of the Altai peaks, with many beautiful mountain lakes and glaciers, attract travelers, scientists, climbers, writers, poets, artists, and photographers.
<b>Altai Territory</b>	Here all travelers will find something to their taste: ancient encampments and caves for archaeologists, Altai cheese and Altai honey for gourmards, the Yarovoye Lake and the Belokurikha resort for fans of retreat. For those looking for communion with nature, there are cozy campsites surrounded by snow-capped mountains, ancient pine trees, and clean taiga air.

Note—compiled by the authors according to Russia Travel, a national tourist portal.

The Republic of Kazakhstan, in turn, borders the RF in the regions of West Kazakhstan, Aktobe, Kostanay, North Kazakhstan, Pavlodar, East Kazakhstan, and Atyrau.

Table 3 gives a closer look at each one.

**Table 3.** Brief description of the Republic of Kazakhstan's regions in terms of tourism attractiveness.

Region	Brief Description
<b>West Kazakhstan Region</b>	This region was established on 10 March 1932. It is located in the northwestern part of the country and shares borders with five regions of the Russian Federation (Orenburg, Astrakhan, Volgograd, Saratov, and Samara). Flat terrain prevails throughout the area. The highest point is Ichka Mountain. There are approximately 200 rivers in the West Kazakhstan region, the three largest being the Ural, the Derkul, and the Chagan. In addition, there are 144 lakes in the region. Chalkar and Rybny Sacryl are among the largest. Cultural, educational, and religious tourism, and tourism for children and young people, are well-developed in the region.
<b>Aktobe Region</b>	This region is located in the western part of the republic and was also established on 10 March 1932. All the rivers flowing through its territory belong to the Caspian Sea basin; the largest of them are the Emba, Or, Ilek, Irgiz, and Turgay. There are more than 150 lakes in the area. One of the most famous tourist sites is the Abat-Baytak sculptural monument dating back to the beginning of the 13th century. Scientists believe that it was erected during the emergence of the Golden Horde. No less famous are the Koblandy Batyr Mausoleum and the Museum of Local Lore. Cultural, educational, medical, geological, ecological, and event tourism are actively developed in the region.
<b>Kostanay Region</b>	This region, located in the north of the republic, was established in 1936 (the territory consists of 196,000 sq km with a population of 879,100). The region has relatively flat terrain. The northern part consists of the southeastern edge of the West Siberian Lowland, and to the south of it is the Turgai Plateau. In the west of the region is the undulating plain of the Trans-Ural Plateau, and in the southeast, the spurs of Sary-Arka. The Turgai Hollow crosses the territory of the Kostanay region from north to south. In the central part of the Turgai Plateau, Sypsynagash Hollow runs from west to east. In the west is Mount Zhitikara; on the Torgai Plateau are the Kargaly, Zhylandy, Kyzbel, and Teke Mountains; at the eastern foot are the Kyzbel and Kyzemshekhshoky mountains; and in the southeast are the Hill of Zhylanshykturme and Mount Kayyndyshoky. The Altyn Dala State Nature Reserve, the Naurzum State Nature Reserve, and the Mikhailovsky and Tounsorsky State Nature Reserves are located in the region. The region has the potential for the development of cultural, educational, and nature tourism.
<b>North Kazakhstan Region</b>	This region is located in the northern part of the republic. It was established in 1936. The territory of the region covers 98,000 sq km, and the population is 563,300. The northern half of the territory is represented by the Esil Plain and the southern half by the Kokshetau Upland with the Zhaksy Zhangyztai, Imantau, and Ayyrtai mountains. The most popular sites of the region are Mamlyutsky, Smirnovsky, and Orlinogorsky State Natural Reserves, the State Natural Monuments of Zhanazhol, Serebryanny Bor, Sosnovy Bor, and Sopka Orlinaya Gora, as well as a spring. Cultural, educational, gastronomic, and active tourism are well-developed in the region (there is a sports arena, a tennis center, swimming pools, fitness clubs, the Kulager racetrack, lakes, sports and recreational complexes, a rope park, as well as a ski complex with a ropeway). Ecological and social tourism and tourism for children and youth hold promise for development.



Table 3. Cont.

Region	Brief Description
Pavlodar Region	It was established in 1938 and is located in the north-eastern part of Kazakhstan. The total area of the territory is 124,800 sq km, and the population is 757,000. The region features a plain landscape. The right bank of the Irtysh River is located on the Barabinsk Lowland and the Kulyndyn Plain; the left bank is on the Irtysh Plain; and the southwestern part of the region is home to the hilly area of Sary-Arka, where the Bayanaul, Kyzyltau, Zeltau and other mountains stand out. In the region, there is the Bayanaul SNNP (State National Natural Park), as well as the Yertys-Ormany State Forest Nature Reserve, the Kyzyltau State Nature Reserves, and the floodplain of the Irtysh River. Sports (mainly hiking), water sports, and educational tourism are developed in the region. The region has huge potential for the development of ecological, ornithological, mining, and mineralogical tourism.
East Kazakhstan Region	This region, established in 1932, is located in the territory of East Kazakhstan (283,200 sq km and population of 1,389,600). Mountainous and hilly relief, as well as highly rugged terrain characteristics, are typical for a significant part of the region's territory. In the east are the ridges of the Rudny Altai: Ivanovsky, Korzhinsky, Koksusky, Tigretsky, Ulbinsky, and Obninsky. The ridges of the Southern Altai are Katunsky, Southern Altai, and Sarymsakty, and farther south one will find the Kalbinsky Ridge, the Zaisan Basin, and the Tarbagatai Ridges. The western part of the region is represented by the hilly area of eastern Sary-Arka with the mountains of Hanshyngys, Shyngystau, and Akshatau. Also found in the region are the West Altai and Markakol State Nature Reserves; the Katon-Karagai SNNP; the Semey Ormany State Forest Nature Reserve; Kuludzhunsky, Tarbagataysky, and Nizhne-Turgusunsky State Nature Reserves; the Karatal'skiye Peski State Nature Reserve; the Sinegorskaya Pikhtovaya Roshcha State Natural Monument; and the Altai Botanical Garden. Various types of tourism are well-developed in the territory of the East Kazakhstan Region, including rural, beach, water, winter, primary wellness (there are 19 medical centers practicing treatment with specialized facilities), cultural, educational, ecological, sports, and mountain.
Atyrau Region	This region was established in 1938; in the protected areas of the land there is a limestone plateau, which was once the bottom of an ancient ocean. The territory of the region is a semidesert and desert lying in the Caspian lowland plain. The region has a well-developed oil and gas industry. Some of the famous architectural monuments are mausoleums, such as Zhuban-Tam, made of mountain shell rock and crowned with a helmet-shaped dome, as well as Asaly-Koketai, a domed structure with an ornately shaped spire built in 1877. In this region, cultural, educational, water, beach, business, and event tourism have become popular.

Note—compiled by the authors according to tourist portal on VisitKazakhstan and data from tochka-na-karte.ru.

To calculate the TRP value of the border areas, the initial data presented in Appendix A (Table A1) and Appendix B (Table A2) were used in Steps 1–7, which are not presented in detail as this technique was previously developed, described in detail and tested by the authors of the article (Mamraeva and Tashenova 2020) as part of the scientific work “Methodological Tools for Assessing the Region’s Tourist and Recreation Potential”, in the context of which the authors do not consider it necessary to describe the intermediate step-by-step stages in detail in this scientific article as they consider the final calculation of the tourism and recreational potential of the cross-border regions of Russia and Kazakhstan to be more important. This article includes a link to a previously published paper using the author’s methodology.

For the calculation of the tourism and recreational potential based on secondary data, the methodology proposed by Dirin, Krupochkin and Golyadkina (Dirin et al. 2014) for a comprehensive assessment of tourism and recreational potential was used. In our interpretation, the methodology is complemented by socio-economic, cultural-historical factors, and sub-factors, as well as a set of parameters for the factor “safety of tourism infrastructure”. All data for the calculations were obtained from statistical information sources for each of the cross-border regions of Russia and Kazakhstan; they are listed in Appendix A (Table A1) and Appendix B (Table A2) to this article. Subsequently, the values obtained were divided into groups of factors, for each of which an integral indicator was calculated. Based on the arithmetically weighted average, the final integral assessment of tourism and recreation potential was then produced for each of the regions of Russia and Kazakhstan under consideration. All steps are shown in detail in Figure 1 (Section 3).

Then, TRP estimation corridors were obtained (Table 4).

Table 4. Obtained TRP estimation steps for the cross-border regions of RF and RK.

Estimation Steps	Cluster 1 (Step—0.023)	Cluster 2 (Step—0.023)	Cluster 3 (Step—0.083)	Cluster 4 (Step—0.023)	TRP Final Value (Step—0.118)
Low Potential (LP)	0.052–0.075	0.042–0.065	0.168–0.251	0.071–0.094	0.402–0.520
Medium Potential (MP)	0.076–0.099	0.066–0.089	0.252–0.335	0.095–0.118	0.521–0.639
Above-Medium Potential (AMP)	0.1–0.123	0.09–0.113	0.336–0.419	0.119–0.142	0.64–0.758
High Potential (HP)	More than 0.123	More than 0.113	More than 0.419	More than 0.142	More than 0.758

Note—obtained based on calculations made.

TRP calculation results are shown in Figure 2 (Step 8).

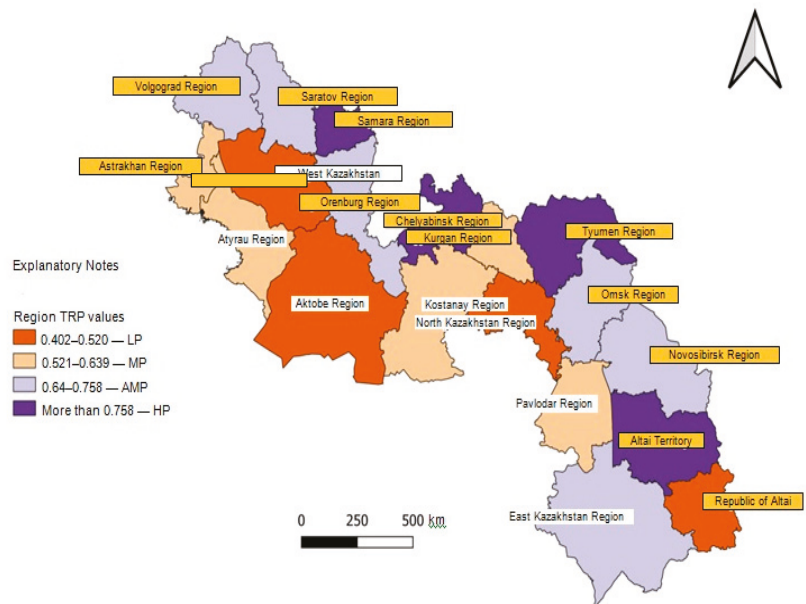


Figure 2. Territorial specificities of tourism and recreational potential of cross-border regions of the RF and RK.

According to our calculations, the following regions have high tourism and recreational potential: Samara, Chelyabinsk, Tyumen, and the Altai Territory. Regions with above-medium potential in the Russian Federation are Volgograd, Saratov, Orenburg, Omsk, and Novosibirsk, while only East Kazakhstan has above-medium potential in the Republic of Kazakhstan. Regions of medium and low potential include Astrakhan, Kurgan, and the Altai Republic in the RF and West Kazakhstan, Aktobe, and North Kazakhstan in the RK.

The interpretation of the results presented in Figure 2 is reflected in Table 5.

**Table 5.** TRP levels of cross-border areas of the RF and RK (Steps 8–9).

Region	Cluster 1	Cluster 2	Cluster 3	Cluster 4	TRP Final Value
<b>Russian Federation</b>					
Astrakhan Region	LP	MP	MP	AMP	MP
Volgograd Region	MP	AMP	AMP	AMP	AMP
Saratov Region	LP	MP	AMP	MP	AMP
Samara Region	MP	AMP	AMP	HP	HP
Orenburg Region	AMP	MP	AMP	MP	AMP
Chelyabinsk Region	MP	HP	AMP	HP	HP
Kurgan Region	LP	MP	MP	MP	MP
Tyumen Region with ADs (Autonomous Districts)	HP	MP	HP	HP	HP
Omsk Region	MP	AMP	MP	MP	AMP
Novosibirsk Region	AMP	HP	AMP	AMP	AMP
Altai Territory	HP	AMP	HP	AMP	HP
Republic of Altai	AMP	LP	LP	LP	LP
<b>Republic of Kazakhstan</b>					
West Kazakhstan Region	MP	MP	LP	LP	LP
Aktobe Region	MP	MP	LP	LP	LP
Kostanay Region	MP	MP	MP	LP	MP
North Kazakhstan Region	AMP	MP	LP	LP	LP
Pavlodar Region	MP	AMP	MP	LP	MP
East Kazakhstan Region	HP	AMP	MP	AMP	AMP
Atyrau Region	MP	LP	LP	AMP	MP

Note—compiled based on the results of calculations.

In the structure of the tourism and recreational potential of the Russian regions, the values of AMP (35.4%), MP (33.3%), HP (18.8%), and LP (12.5%) prevail. Social and Economic and Infrastructure Support of Tourism are the best-developed clusters. This is where the above-medium potential and medium potential estimations prevail.

As for the TRP levels of the Kazakhstan regions, the highest estimations are MP (42.9%) and LP (35.7%). Cultural and historical factors and natural factors are the best developed clusters in the structure of potential. A low level of social, economic, and infrastructural factors increases the risks of inefficient realization of tourism and recreational potential of the regions.

We have also summarized the studies of tourism-associated risks during the COVID-19 pandemic to obtain the following conclusions applicable at the global level:

- The risks for the tourism industry during the pandemic were collective and depended on compliance with safety recommendations by residents and visitors of certain regions.
- Risks of economic losses in tourism arose regardless of the severity of quarantine restrictions. With strong isolation of the area due to a drop in the tourist flow, there was a threat of tourist organization closures, job losses, a reduction or complete loss of income, and a decrease in tax receipts. With weak isolation of the region, there was risk of infection for the local population and a risk of income decline for the economy.

It is necessary to find a balance between safety requirements during a pandemic and the risk of economic losses. Under these conditions, the support of federal, republican, and regional authorities to organizations of the industries affected by COVID-19 is crucial.

- The authorities should consider the impact of the pandemic not only in light of the risk to the economy but also in light of the risk to the social and environmental spheres. The pandemic has shown that the authorities must be ready not only to respond quickly to the need to ensure the safety of tourists and local residents but also to mitigate the risks in the social and environmental spheres.
- The behavior of tourists and the generation of tourist flow are influenced not only by actual risks but also by potential exposure to risks when visiting a certain region. The perception of risk can negatively affect an area's image and make it difficult to realize the tourist potential of the region. In this situation, the importance of informing tourists about safety measures to minimize the risk of visiting the region increases.
- The pandemic has increased the number of tourism-associated risks and has shown a need for each person (tourists and personnel of travel companies) to comply with safety requirements (social distancing, use of disinfectants, use of masks, etc.). Before the pandemic, safety in tourism had been provided mainly by organizations of the tourism industry and tourist infrastructure. During the pandemic, travel safety became a problem not only for the tourism industry but also for every tourist and the authorities of the region. However, some destinations and types of tourism (ecological, rural tourism, etc.), as well as remote tourist areas, have experienced increased demand due to the opportunity to leave large cities with an increased risk of COVID-19 infection.

**An important aspect of tourism development in the cross-border regions of the Republic of Kazakhstan and the Russian Federation is the consideration and prevention of the following risks:**

1. The existing restrictions regarding the use of Visa and MasterCard payment systems will make it difficult to pay for services related to accommodations, food, housing, and transport; it should also be noted that when planning tourist trips, residents of the Republic of Kazakhstan may face a shortage of rubles in second-tier banks and be unable to use Visa or MasterCard, which may lead to reduced consumption of tourist products, as well as to changes in the timing of travel due to the need to search for convenient payment methods. This situation should improve once credit cards become valid in RF territory (for example, the Mir system).
2. The inability to book hotels via the Booking.com online platform creates limitations and difficulties in the planning process and the generation of optimal tourist products. It also increases the amount of time that potential tourists spend searching for suitable facilities and accommodations.
3. Changes in natural and climatic conditions may have an adverse impact on average annual precipitation, the period of seasonal snow cover, and the time period that determines snowmelt, which in turn can lead to intensive flooding of natural tourist areas during spring floods, for example.
4. The shallowing and overgrowth of small lakes (medium and large) that have not been taken into account in the TRP assessment can lead to a reduction in tourist flows in beach tourism development within certain areas. These trends have been observed in a mild form at Sabandykol Lake in Bayanaul State National Natural Park of the Pavlodar Region, North Kazakhstan; at the Sol-Iletsy Lakes in the Orenburg Region; and at Yarovoye Lake in Altai Territory.
5. The weathering of rocks in the areas of tourist destinations, which can lead to destruction of places of interest.
6. The destruction and deterioration of tourism infrastructure and noncompliance with international standards.

7. A low flow capacity in tourist areas, which can potentially lead to over-tourism in the case of an “influx” of incoming tourists, especially during a peak season. Such a situation has been observed for the last five years in Bayanaul National Natural Park and Alakol Lake, located on the Balkhash-Alakol Lowland (on the border of the Almaty and East Kazakhstan regions), and in the territories of Biryuzovaya Katun SEZ in Altai Territory.
8. Existing restrictions due to the COVID-19 pandemic, including mandatory PCR tests when crossing the border (by air transport), masking, registration in the COVID-19 Free Travel Program, and participation in state programs for scanning QR codes for admission to restaurants and entertainment facilities. It should be noted that due to improvements in the epidemiological situation, on 11 March 2022, the Kazakhstan Interdepartmental Commission on Preventing the Spread of Coronavirus Infection decided to cancel mandatory masking outdoors, as well as the use of the Ashyq mobile application (only for regions located in the ‘yellow’ and ‘green’ zones).

## 5. Discussion

Studies show that the COVID-19 pandemic was one of the most catastrophic events for tourism. The globalization of tourism has started to be considered not only as an advantage but also as a problem due to the significant risk of disease spread within tourist flows. The example of countries and regions actively developing inbound tourism, and therefore most affected due to coronavirus restrictions, clearly shows a need to pay greater attention to all types of risks in tourism. *We highlight the main debatable issues based on the results of the research.*

1. Conventionally, the major risks associated with tourism are economic. The consequences of the pandemic, however, have shown that health risks are also a problem, and have pointed out the need to ensure increased safety for tourists and the local population in order to preserve lives and health. However, there are still no data in the statistical indicators that allow assessment of the impact of the risk of COVID-19 on the development of tourism in cross-border territories. This is due to a lack of data on the movement of tourists after they cross the border, and the lack of a selective study of the purposes for visiting the country. The most accurate information on the movement of tourists is currently provided by mobile operators, but such information is expensive and not available to individual researchers. The solution to the problem of tracking the movement of tourists could be, for example, the use of a “tourist passport”. In this document, the tourist could receive marks at certain destinations, which would allow him to receive discounts and/or souvenirs. A tourist passport has been implemented in a number of destinations and routes in Russia.
2. Restrictions on tourist flows have led not only to economic consequences (a decrease in revenue, investments, and tourism wages) but also to a reinterpretation of the role individual entities play in the generation of tourist flows. Long-term pandemic restrictions have required state support, primarily financial and tax support, to prevent the bankruptcy of tourism enterprises. As part of another study we conducted, we looked at the impact of digital solutions on tourism support by state authorities. This study showed that the efficiency of tourism recovery in the border regions of the Russian Federation and Kazakhstan depends on the completeness and relevance of state information support measures. It should be noted that state support measures (at the federal and regional levels) did not appear immediately. The tourism industry was left to fend for itself with a catastrophic decline in tourist traffic due to border closures during the first few months of the pandemic. In our opinion, it is necessary to foresee possible scenarios for supporting tourism in advance, taking into account the consequences of the COVID-19 pandemic.
3. Significant growth in industry digitalization is another consequence of the pandemic. There are no indicators in the official statistics of either country that reflect the level of digital technology application in tourism. Nevertheless, this factor has a significant

impact on the possibility of realizing the region's tourist potential. This trend has led to a reduction in the revenue of tour operators and travel agents, but allowed tourist service providers to maintain their level of revenue and reduce the drop in tourist flow in the regions. The pandemic has shown that, despite restrictions, the demand for travel has continued. A rapidly changing situation with the introduction of restrictive measures and the COVID-19 infection rate has led to reduced booking depth when buying tourist products, and the growing popularity of last-minute tours. Under these conditions, official information on pandemic restrictions has come into sharp focus.

A pent-up demand has been primarily satisfied in areas where coronavirus restrictions were first lifted (even partially). The example of the tourist flow volume in Turkey after a number of restrictions had been lifted shows the significance of coordination between state authorities, tourism industry organizations, and tourism infrastructure to reduce risks and ensure a safe holiday for tourists. However, these measures should be global or at least coordinated by the authorities of the countries and/or regions with the greatest mutual tourist flows, since the removal of exit restrictions may be offset by remaining entry restrictions. The use of digital technologies in the context of limited social contact has made it possible to rebuild the mechanisms of interaction between tourism organizations and customers. In the context of the removal of coronavirus restrictions, the vast majority of travel agencies used digital technologies as intensively as they had done during the pandemic. It can be said that COVID-19 elicited an active interest in digital services, even among organizations that were not planning to digitize.

4. More than thirty years since the breakup of the USSR and the transformation of the regions in question into border regions, a number of them have taken advantage of their cross-border position in terms of tourism development. The results of the research clearly show that not all regions have been able to realize their potential to the same extent. Reduced transportation costs when visiting neighboring regions (including those in another country) ceased to be a competitive advantage during the pandemic. The popularity of a particular tourist destination during the pandemic has fueled the safety concerns of a number of tourists and increased the risk of a refusal to travel.

Most regions of the Russian Federation located on the border with Kazakhstan belong to the 'semi-periphery' of tourism and recreational potential. Remoteness from the main centers of demand generation (Moscow and St. Petersburg) negatively impacts the realization of the tourist and recreational potential of these regions, which, however, is somewhat compensated for by good transport accessibility and a relatively high level of tourist infrastructure development. In turn, cross-border regions of Kazakhstan are also 'semi-peripheral' regions that, despite the existing tourism and recreational potential, cannot adequately compensate for the negative factors of remoteness and the currently insufficient development of tourism infrastructure. These regions can be invited to consider the possibility of using the EU Cross-Border Cooperation Program to form an integrated plan for the development of cross-border territories.

## 6. Conclusions

Given the relatively high tourism and recreational potential of the regions of the Russian Federation and the large capacity of the domestic tourism market, the magnitude of the risks from the influence of global factors is lower on the Russian side of the border than on the Kazakhstan side. However, the cross-border location of the regions has significantly increased the risks due to the closure of borders during the COVID-19 pandemic. The introduction of restrictions has led to a decrease in tourist flow and a decrease in the overall efficiency of the implementation of the tourism and recreational potential of cross-border regions. In the context of growing global risks, the general recommendation for

the executive authorities of cross-border regions is to search for new markets within the country and change marketing policies.

In addition, we believe that the strategies and mechanisms for overcoming the crisis will depend on the level of regional tourism and recreational potential. Based on the results of the research, for regions with high potential (Samara, Chelyabinsk, the Tyumen region with autonomous Okrug, and Altai Territory) and above-average potential (Volgograd, Saratov, Orenburg, Omsk, and Novosibirsk), the main mechanism for increasing the efficiency of tourism development is to participate in the national project titled "Tourism and Hospitality Industry." Given the diversity of forms of tourism potential, we recommend choosing a strategy for diversifying tourism activities based on the cluster mechanism.

Regions with medium (Astrakhan and Kurgan) and low potential (Republic of Altai) should be oriented toward the domestic tourist flow, applying the strategy of specialization, and gaining a competitive advantage in the most promising market niche. The efforts of executive authorities should be directed toward the implementation of regional tourism development programs and support for small- and medium-sized businesses. To increase competitiveness, we recommend developing interregional cooperation, which contributes to the formation of a synergistic effect, and an increase in the efficiency of potential realization.

The results of the assessment of the TRP in the regions of Kazakhstan that border Russia confirm the need to improve state policy in the field of regional tourism management, in particular to develop a mechanism for responding to emerging global and local risks. For regions with relatively low potential in terms of tourism infrastructure and socio-economic conditions (West Kazakhstan, Aktobe, and North Kazakhstan), it is necessary to increase entrepreneurial activity by creating acceptable economic conditions and minimizing entry barriers to the tourism market for small- and medium-sized businesses (expansion of the trading network, construction of new hotels and catering facilities, etc.). These activities will increase investment and, as a result, the attractiveness of these regions as tourist destinations, especially since the natural and cultural-historical sub-potentials of the marked areas are rated as average and above average. The use of a follow-the-leader strategy is recommended.

Regions with average tourist potential (Kostanay, Pavlodar, Atyrau) and above-average potential (East Kazakhstan) should focus not only on the development of domestic but also on inbound tourism, mainly increasing throughput from cross-border regions. These areas, taking into account the level of tourism infrastructure development and the presence of a variety of natural, cultural, and historical sites, should apply a strategy for diversifying tourism products, as well as a strategy for intensifying commercial efforts, developing a regional tourist brand, and a strong advertising campaign to promote regional tourism.

*With regard to the limitations of the study*, we note that there is some dependence on the availability and accessibility of certain statistical information, as well as on the choice of parameters and assessment indicators in the methodology developed by the authors. Despite this, future studies could continue to examine the tourism and recreational potential of other regions of the analyzed countries. Further studies could also be directed toward the research and development of competitive regional tourism products.

The results of the research showed that the tourism and recreational potential of the cross-border regions of Russia is mainly estimated at above-average and average levels, while for the corresponding regions of Kazakhstan it is estimated at an average level. At the same time, the existing limitations indicated by the factors and parameters included in the analysis should be taken into account. In general, it is important to note that the methodology presented for assessing TRP is adaptive and allows for comprehensive research. Consequently, it determines directions for improving the infrastructure and socio-economic security of tourism, and helps develop competitive tourism products, depending on the availability of natural and cultural resources.

It should also be noted that the authors' future research will also be related to the study of the specifics of risk assessment in tourism.

**Author Contributions:** Conceptualization, A.T., L.T., Y.K., D.M. and D.R.; methodology, A.T., L.T., Y.K., D.M. and D.R.; software, L.T., Y.K. and D.M.; validation, A.T., L.T., Y.K. and D.M.; formal analysis, A.T., L.T., Y.K. and D.M.; investigation, A.T., L.T., Y.K. and D.M.; resources, A.T., L.T., Y.K. and D.M.; data curation, A.T., L.T., Y.K. and D.M.; writing—original draft preparation, A.T., L.T., Y.K. and D.M.; writing—review and editing, A.T., D.M. and D.R.; visualization, L.T., Y.K. and D.M.; supervision, A.T., L.T., Y.K., D.M. and D.R.; project administration, L.T., Y.K., D.M. and D.R.; funding acquisition, D.R. All authors have read and agreed to the published version of the manuscript.

**Funding:** This research was partially funded by the Ministry of Science and Higher Education of the Russian Federation under the strategic academic leadership program "Priority 2030" [(Agreement 075-15-2021-1333 dated 30.09.2021)].

**Conflicts of Interest:** The authors declare no conflict of interest.

## Appendix A



Table A1. Initial Data for TRP Value Calculation for the Cross-Border Regions of Russia.

Indicator	Astrakhan Region	Volgograd Region	Saratov Region	Samara Region (Borders Only at One Point)	Orenburg Region	Chelyabinsk Region	Kurgan Region	Tyumen Region with ADs (Autonomous Districts)	Omsk Region	Novosibirsk Region	Altai Territory	Republic of Altai
Average temperature in January, °C	-3.6	-5.9	-7.5	-13.8	-11.7	-14.6	-18	-15	-16.8	-18.9	-16.1	-13.7
Average temperature in July, °C	25.6	24.6	22.6	20.7	23.2	19.6	19	19	19.6	19.1	19.9	18.9
Average annual precipitation, mm	222	450	550	372	380	529	400	480	400	464	448	731
First snow cover in the first half of December, which can melt several times during the winter. Its depth is shallow—only about 4–10 cm.												
Period of seasonal snow cover, days	100	100	100	138	145	160	155	145	185	160	180	200
Absolute elevation of the terrain relief, m	161.9	358.6	370	381.2	667.6	1406	210	1895	150.4	502	2490	4506
Number of lakes (large, more than 100 sq. km), units	1	1	0	0	0	0	0	2	2	4	2	1
Number of rivers (large, more than 500 km), units	0	1	0	0	1	0	0	12	2	4	4	0
Number of SPNRs (Specially Protected Natural Reservations), units	56	58	92	215	336	155	123	139	27	82	121	58
Number of protected plant species, units	143	46	306	286	183	230	208	173	188	179	212	180
Number of protected animal species, units	187	143	253	272	138	182	156	142	197	157	146	135
Number of natural monuments (of republican significance)/in RE, SPNRs, units	3	5	2	4	3	4	0	9	1	2	5	4

Table A1. Cont.

Indicator	Astrakhan Region	Volgograd Region	Saratov Region	Samara Region (Borders Only at One Point)	Orenburg Region	Chelyabinsk Region	Kurgan Region	Tyumen Region with ADs (Autonomous Districts)	Omsk Region	Novosibirsk Region	Altai Territory	Republic of Altai
Number of historical and cultural monuments (of republican (federal) significance), units.	44	66	61	110	37	18	19	53	10	10	34	0
Number of archaeological monuments (of republican (federal) significance), units	98	1227	98	25	1287	292	708	1094	1202	639	2263	117
Number of monuments of urban planning and architecture (of republican (federal) significance), units	Since 2013, the list has not been maintained in the Russian Federation; they are included in the category of Cultural Heritage Sites											
Number of museums, units	19	40	27	38	32	46	23	18	40	39	69	7
Number of theaters, units	4	11	11	16	7	16	3	4	10	10	7	1
Number of zoos (including petting zoos), units.	0	0	0	1	0	1	0	0	1	1	0	0
Number of concert organizations, units	4	7	2	5	1	4	1	1	6	5	6	3
Number of circuses, units	2	1	2	1	1	2	0	1	1	1	0	0
Number of libraries, units	238	599	920	735	897	819	514	468	773	860	960	157
Number of movie theaters, units (including those with 2–7 screens)/in RE; number of movie installations (unit; the indicator value for the year)	8	71	0	29	106	64	65	7	90	82	111	0
Number of entertainment and recreation parks, units/in RE; of culture and recreation	0	6	1	2	0	10	0	0	3	11	5	0
Consumer product retail chains, quantity	9828	26,847	27,300	37,581	23,050	35,545	13,037	39,800	17,956	28,475	31,075	3365

Table A1. Cont.

Indicator	Astrakhan Region	Volgograd Region	Saratov Region	Samara Region (Borders Only at One Point)	Orenburg Region	Chelyabinsk Region	Kurgan Region	Tyumen Region with ADs (Autonomous Districts)	Omsk Region	Novosibirsk Region	Altai Territory	Republic of Altai
Number of trade markets, units	8	37	28	16	15	16	3	16	13	10	20	2
Density of railway tracks, km per 1000 sq. km	128	143	228	256	117	203	104	17	53	85	86	0
Length of public hard-surfaced motor roads, km	4078	16,653.4	17,259.9	17,959.8	20,664.6	21,370.1	9601.7	23,280.6	14,109.3	20,579.9	35,343.7	4604.5
Number of physical exercise and sports facilities (including number of ski resorts, rowing clubs, sports arenas, etc.). units	1312	3928	3177	4181	3908	5516	2165	5896	3997	3565	4690	325
Number of primary wellness tourism facilities—sanatorium- and-spa resorts, specialized medical centers, etc./in RF, number of sanatorium-resort organizations	3	23	23	39	27	43	19	30	16	34	38	2
Number of five-star hotels, units	3	3	0	3	2	2	0	0	0	0	1	2
Number of four-star hotels, units	6	12	9	18	5	21	4	16	5	19	10	5
Number of three-star hotels, units	11	35	38	67	26	31	4	66	16	19	21	10
Number of accommodations w/o category, as well as one- and two-star hotels, units	10	18	16	35	13	19	7	46	12	20	25	7
Hotel room capacity, units/in RF; number of rooms in collective accommodation facilities	6841	10,922	8955	18,400	6905	18,964	2987	18,051	7053	12,817	12,886	4278

Table A1. Cont.

Indicator	Astrakhan Region	Volgograd Region	Saratov Region	Samara Region (Borders Only at One Point)	Orenburg Chelyabinsk Region	Kurgan Region	Tyumen Region with ADs (Autonomous Districts)	Omsk Region	Novosibirsk Region	Altai Territory	Republic of Altai
Number of airports, units, in RF, international only	1	1	1	1	2	1	1	1	1	1	0
Number of tourism companies and tour operators, units.	115	165	169	327	118	60	474	182	307	171	28
Headcount of workers in tourism sector, in thousands	0.937	0.418	0.349	0.845	0.234	0.856	0.803	0.489	0.939	0.371	0.094
Headcount of workers in collective accommodation facilities in RF regions, in thousands	3.175	4.24	4.718	9.166	4.375	2.791	10.618	4.242	6.476	8.71	1.257

Note—compiled according to data from the following sources:

1. Great Russian Encyclopedia [Electronic resource]. URL: <https://bigenc.ru/> (accessed on 21 January 2022).
2. Federal list of tourist sites [Electronic resource]. URL: <https://xn----7sba3acabblidhv3chawrf5bzn.xn--p1ai/> (accessed on 22 December 2021).
3. Federal State Statistics Service [Electronic resource]. URL: <https://rosstat.gov.ru/compendium/document/13295> (accessed on 22 January 2022).
4. Unified interdepartmental information and statistical system [Electronic resource]. URL: <https://www.fedstat.ru/indicator/55126> (accessed on 22 January 2022).
5. Federal Air Transport Agency of Russia [Electronic resource]. URL: <https://favt.gov.ru/dejatelnost-ajeroporty-i-ajerodromy-mezhdunarodnye-ajeroporty/> (accessed on 18 January 2022).
6. Regions of Russia. Socio-economic indicators. 2021: P32 statistical collection/Rosstat-M., 2021, 1112p.
7. Voronin, V.V. Geography of the Samara Region/V.V. Voronin, V. A. Gavrilenkova, Voronin V. V., Gavrilenkova V. A.; State educational institution of additional professional education (advanced training) of specialists Samara Regional Institute for Advanced Studies and Retraining of Educational Workers.—Samara: GOU SIPKRO, 2008, 265p. ISBN 978-5-7174-0408-2.
8. Geography of the economy of the Saratov region/L.A. Ilchenko, L.V. Makartseva, Yu.V. Preobrazhensky, O.A. Isoberg.—Saratov: IC “Science”, 2018, 99p. ISBN 978-5-9999-3083-5.
9. Nature of the Novosibirsk region: electronic textbook/T.A. Gorelova, N.V. Gulyaeva, V.M. Kravtsov, Yu.V. Kravtsov; Federal Agency for Education, Novosibirsk State Pedagogical University, Institute of Natural and Social and Economic Sciences, Department of Physical Geography.—Novosibirsk: Novosibirsk State Pedagogical University, 2010, 160 p.
10. Ivanishcheva, N.A. Geography of the Orenburg region: textbook/N.A. Ivanishcheva, I.Yu. Filimonova, Zh.T. Sivokhip.—Orenburg: LLC “Agency” Press”, 2020, 121p.

## Appendix B

Table A2. Initial Data for TRP Value Calculation for the Cross-Border Regions of Kazakhstan.

Factor and Sub-Parameters	Atyrau Region	West Kazakhstan Region	Aktobe Region	Kostanay Region	North Kazakhstan Region	Pavlodar Region	East Kazakhstan Region	AVI
Average temperature in January, °C	-8 (-11)	-14	-20.8	(-13.8)-(-16.1)	(-12.8)-(-17.4)	(-14.9)-(-17.0)	(-16)-(-20)	-
Average temperature in July, °C	+24 (+25)	+25	+23.7	20.0-23.6	20.3-21.9	19.1-20.6	16-23	-
Average annual precipitation, mm	100-200	325	213-250	388	349	454	477	-
Period of seasonal snow cover, days	70-90	86-142	89-161	105-160	129-154	150-165	142	-
Absolute elevation of the terrain relief, m	(-27.16)-223 Av.: 125	100-657 Av.: 378	100-200-657 Av.: 379	250-320	100-200	115-200	500-600; 2800-3600	-
Number of lakes (large, more than 100 sq. km), units	1	1	1	3	2	5	3	1.4
Number of rivers (large, more than 500 km), units	4	1	6	2	3	1	1	1.2
Number of SPNRs (Specially Protected Natural Reservations), units	3	3	2	5	16	5	12	7
Number of protected plant species, units	16	36	61	1112	831	58	4322	1873
Number of protected animal species, units	30	20	32	783	312	90	1662	606
Number of natural monuments (of republican significance), units	3	3	2	-	1	12	1	2

Table A2. Cont.

Factor and Sub-Parameters	Atyrau Region	West Kazakhstan Region	Aktobe Region	Kostanay Region	North Kazakhstan Region	Pavlodar Region	East Kazakhstan Region	AVI
Number of historical and cultural monuments (of republican (federal) significance), units	4	5	9	5	3	7	16	14
Number of archaeological monuments (of republican (federal) significance), units	-	1	-	-	-	1	2	3
Number of monuments of urban planning and architecture (of republican (federal) significance), units	2	4	6	5	3	6	14	10
Number of museums, units	17	9	19	10	13	11	17	15
Number of theaters, units	1	2	2	4	3	3	2	4
Number of zoos (including petting zoos), units	-	-	3	-	-	1	1	0.5
Number of concert organizations, units	2	3	1	1	1	1	2	2
Number of circuses, units	-	-	-	-	-	-	-	0.25
Number of libraries, units	144	366	237	344	321	230	306	231
Number of movie theaters, units (including those with 2–7 screens)	2	7	2	5	3	4	6	6
Number of entertainment and recreation parks, units	2	5	7	9	6	4	11	9

Table A2. Cont.

Factor and Sub-Parameters	Atyrau Region	West Kazakhstan Region	Aktobe Region	Kostanay Region	North Kazakhstan Region	Pavlodar Region	East Kazakhstan Region	AVI
Consumer product retail chains, quantity	2786	4688	5644	9988	6054	8889	12,696	7115
Number of trade markets, units	22	20	59	43	30	24	71	45
Density of railway tracks, km per 1000 sq. km	6.26	2.11	6.08	6.49	6.31	6.32	4.27	5.89
Length of public hard-surfaced motor roads, km	2322.3	4676.2	5530.5	6763.9	6981	4919	10,352.9	5559.2
Number of physical exercise and sports facilities (including number of ski resorts, rowing clubs, sports arenas, etc.) units	1128	1699	1831	2562	2891	3083	3245	2432
Number of primary wellness tourism facilities—sanatorium-and-spa resorts, specialized medical centers, etc.	5	3	4	5	3	5	10	9
Number of five-star hotels, units	3	-	-	-	-	-	1	1
Number of four-star hotels, units	5	1	1	4	1	-	1	4
Number of three-star hotels, units	6	1	3	3	-	-	5	3
Number of accommodations w/o category, as well as one- and two-star hotels, units	74	38	56	101	50	65	172	108



Table A2. Cont.

Factor and Sub-Parameters	Atyrau Region	West Kazakhstan Region	Aktobe Region	Kostanay Region	North Kazakhstan Region	Pavlodar Region	East Kazakhstan Region	AVI
Hotel room capacity, units	3216	1751	2010	2287	1824	3090	10,919	4285
Number of airports, units	2	1	1	1	1	1	4	1
Number of tourist companies and tour operators, units	25	40	31	34	22	41	30	79
Headcount of workers in the tourism sector, in thousands	4.5	6.4	4.7	5	3.1	6	8.7	6.5

Note—compiled according to data from the following sources:

1. [stat.gov.kz](http://stat.gov.kz)
2. Agroclimatic Resources of the West Kazakhstan Region: scient. and appl. ref./Institute of Geography LLP, Astana, 2017, 128p;
3. Agroclimatic Resources of the Aktobe Region: scient. and appl. ref./Institute of Geography LLP, Astana, 2017, 136p;
4. Agroclimatic Resources of the Kostanay Region: scient. and appl. ref./Institute of Geography LLP, Astana, 2017, 139p;
5. Agroclimatic Resources of the Pavlodar Region: scient. and appl. ref./Institute of Geography LLP, Astana, 2017, 127p;
6. Agroclimatic Resources of the North Kazakhstan Region: scient. and appl. ref./Institute of Geography LLP, Astana, 2017, 125p;
7. Hydrology—Astana: The official internet resource of Kazhydromet RSE of the Ministry of Energy of the Republic of Kazakhstan. [Electronic Source]. URL: <https://kazhydromet.kz/ru> (accessed on 31 January 2022).
8. The Law of the Republic of Kazakhstan “On Protection and Use of Historical and Cultural Heritage Sites” No. 1488-XII dated 2 July 1992 (as amended and supplemented as of 24.05.2018) // Paragraph Information system [Electronic source].—E-data—[Astana, 2018];
9. Tourism of Kazakhstan, 2016–2020: Stat. ref./Agency for Strategic Planning and Reforms of the Republic of Kazakhstan. Bureau of National Statistics, Nur-Sultan, 2021, 101p;
10. Culture in the Republic of Kazakhstan, 2016–2020: Stat. ref./Agency for Strategic Planning and Reforms of the Republic of Kazakhstan. Bureau of National Statistics, Nur-Sultan, 2021, 130p;
11. Retail and Wholesale Trade in the Republic of Kazakhstan, 2016–2020: Stat. ref./Agency for Strategic Planning and Reforms of the Republic of Kazakhstan. Bureau of National Statistics, Nur-Sultan, 2021, 279p;
12. Transport in the Republic of Kazakhstan, 2016–2020: Stat. ref./Agency for Strategic Planning and Reforms of the Republic of Kazakhstan. Bureau of National Statistics, Nur-Sultan, 2021, 119p.

## References

- Aletdinova, Anna, and Maxim Bakaev. 2019. Intelligent Data Analysis and Predictive Models for Regional Labor Markets. In *Digital Transformation and Global Society*. Communications in Computer and Information Science. Edited by Daniel A. Alexandrov, Alexander V. Boukhanovsky, Andrei V. Chugunov, Yury Kabanov, Olessia Koltsova and Ilya Musabirov. Cham: Springer International Publishing, vol. 1038, pp. 351–63. [\[CrossRef\]](#)
- Arbulú, Italo, Maria Razumova, Javier Rey-Maqueira, and Francesc Sastre. 2021. Measuring Risks and Vulnerability of Tourism to the COVID-19 Crisis in the Context of Extreme Uncertainty: The Case of the Balearic Islands. *Tourism Management Perspectives* 39: 100857. [\[CrossRef\]](#) [\[PubMed\]](#)
- Boldyrev, Yury, Sergey Chernogorskiy, Konstantin Shvetsov, Anatoly Zherelo, and Konstantin Kostin. 2019. A Mathematical Model of Regional Socio-Economic Development of the Russian Arctic Zone. *Resources* 8: 45. [\[CrossRef\]](#)
- Borovkov, Aleksey I., Marina V. Bolsunovskaya, Aleksei M. Gintciak, and Tatiana Ju Kudryavtseva. 2020. Simulation Modelling Application for Balancing Epidemic and Economic Crisis in the Region. *International Journal of Technology* 11: 1579. [\[CrossRef\]](#)
- Chan, Chung-Shing. 2021. Developing a Conceptual Model for the Post-COVID-19 Pandemic Changing Tourism Risk Perception. *International Journal of Environmental Research and Public Health* 18: 9824. [\[CrossRef\]](#) [\[PubMed\]](#)
- Cheng, Yun, Sha Fang, and Jie Yin. 2022. The Effects of Community Safety Support on COVID-19 Event Strength Perception, Risk Perception, and Health Tourism Intention: The Moderating Role of Risk Communication. *Managerial and Decision Economics* 43: 496–509. [\[CrossRef\]](#) [\[PubMed\]](#)
- Chernogorskiy, Sergey, Konstantin Shvetsov, and Vladimir Parkhomenko. 2018. Two Prediction Models for Some Economic Indicators of the Russian Arctic Zone. In *Proceedings of SAI Intelligent Systems Conference (IntelliSys) 2016*. Lecture Notes in Networks and Systems. Edited by Yaxin Bi, Supriya Kapoor and Rahul Bhatia. Cham: Springer International Publishing, vol. 15, pp. 358–67. [\[CrossRef\]](#)
- Chica, Manuel, Juan M. Hernández, and Jacques Bulchand-Gidumal. 2021. A Collective Risk Dilemma for Tourism Restrictions under the COVID-19 Context. *Scientific Reports* 11: 5043. [\[CrossRef\]](#)
- Dimopoulos, Dimitri, Dorothy Queiros, and Cina Van Zyl. 2021. Perspectives on the Impact of External Risks on the Future of Dive Tourism at a High Latitude Reef Complex in the Indian Ocean Region. *Journal of the Indian Ocean Region* 17: 178–204. [\[CrossRef\]](#)
- Dirin, D., E. P. Krupochkin, and E. Golyadkina. 2014. Methods of integrated assessment of the tourist and recreational potential of the region. *Geography and Nature Management of Siberia* 18: 64–78.
- Godovykh, Maksim, Abraham Pizam, and Frida Bahja. 2021. Antecedents and Outcomes of Health Risk Perceptions in Tourism, Following the COVID-19 Pandemic. *Tourism Review* 76: 737–48. [\[CrossRef\]](#)
- Grech, Victor, Peter Grech, and Stephanie Fabri. 2020. A Risk Balancing Act—Tourism Competition Using Health Leverage in the COVID-19 Era. *International Journal of Risk & Safety in Medicine* 31: 121–30. [\[CrossRef\]](#)
- Im, Jongho, Jewoo Kim, and Joon Yeon Choeh. 2021. COVID-19, Social Distancing, and Risk-Averse Actions of Hospitality and Tourism Consumers: A Case of South Korea. *Journal of Destination Marketing & Management* 20: 100566. [\[CrossRef\]](#)
- Istiak, Khandokar. 2021. Risk, Uncertainty and the Tourism Sector of North Africa. *African Development Review* 33: 329–42. [\[CrossRef\]](#)
- Ivanova, Marina, Tatiana Yakovleva, and Tamara Selenteva. 2020. The Models of Information Asymmetry in the Context of Digitization of Government. In *Proceedings of the International Scientific Conference—Digital Transformation on Manufacturing, Infrastructure and Service*. Saint Petersburg: ACM, pp. 1–6. [\[CrossRef\]](#)
- Joo, Dongoh, Wenjie Xu, Juhee Lee, Choong-Ki Lee, and Kyle Maurice Woosnam. 2021. ‘Residents’ Perceived Risk, Emotional Solidarity, and Support for Tourism amidst the COVID-19 Pandemic. *Journal of Destination Marketing & Management* 19: 100553. [\[CrossRef\]](#)
- Łapko, Aleksandra, Ewa Hacia, Roma Strulak-Wójcikiewicz, Kevser Çınar, Enrico Panai, and Lovorko Lučić. 2021. Eco-Friendly Tourism Decision Making During COVID-19—Sailing Tourism Example. *Sustainability* 14: 134. [\[CrossRef\]](#)
- Lee, Chien-Chiang, Godwin Olasehinde-Williams, and Seyi Saint Akadiri. 2021a. Geopolitical Risk and Tourism: Evidence from Dynamic Heterogeneous Panel Models. *International Journal of Tourism Research* 23: 26–38. [\[CrossRef\]](#)
- Leukhina, Maya, Tatyana Kudryavtseva, and Anton Tikhomirov. 2020. Analysis of Factors of Cross-Border Cooperation in Order to Increase the Competitiveness of Small and Medium-Sized Enterprises in Saint-Petersburg. In *Proceedings of the 2nd International Scientific Conference on Innovations in Digital Economy: SPBPU IDE-2020*. Saint Petersburg: ACM, pp. 1–9. [\[CrossRef\]](#)
- Mamraeva, Dinara Gabitovna, and Larissa Tashenova. 2020. Methodological Tools for Assessing the Region’s Tourist and Recreation Potentia. *Economy of Region* 16: 127–40. [\[CrossRef\]](#)
- Matiza, Tafadzwa, and Elmarie Slabbert. 2022. Tourism Reset: Reimagining South African Domestic Tourism in the Era of Covid-19. *Tourism Review International* 26: 103–20. [\[CrossRef\]](#)
- Nikolova, Liudmila Vasilevna, Dmitriy Grigorievich Rodionov, and Natalya Vladimirovna Afanasyeva. 2017. Impact of Globalization on Innovation Project Risks Estimation. *European Research Studies Journal* 20: 396–410.
- Park, Jinah, Serene Tse, Sherry D. B. Mi, and Haiyan Song. 2022. A Model for Cross-Border Tourism Governance in the Greater Bay Area. *Journal of China Tourism Research*, 1–25. [\[CrossRef\]](#)
- Pérez-Rodríguez, Jorge V., and Maria Santana-Gallego. 2020. Modelling Tourism Receipts and Associated Risks, Using Long-Range Dependence Models. *Tourism Economics* 26: 70–96. [\[CrossRef\]](#)
- Rather, Raouf Ahmad. 2021. Monitoring the Impacts of Tourism-Based Social Media, Risk Perception and Fear on Tourist’s Attitude and Revisiting Behaviour in the Wake of COVID-19 Pandemic. *Current Issues in Tourism* 24: 3275–83. [\[CrossRef\]](#)

- Rodionov, Dmitry, Liudmila Nikolova, Natalia Abramchikova, Maria Velikova, and Kalubi Rawlings Jerry Mazuba. 2020. Development of the Analysis Model of Innovative Projects Efficiency Management in the Context of Digitalization. In *Proceedings of the 2nd International Scientific Conference on Innovations in Digital Economy: SPBPU IDE-2020*. Saint Petersburg: ACM, pp. 1–7. [\[CrossRef\]](#)
- Rodionov, Dmitriy G., Evgenii A. Konnikov, and Magomedgusen N. Nasrutdinov. 2021. A Transformation of the Approach to Evaluating a Region's Investment Attractiveness as a Consequence of the COVID-19 Pandemic. *Economies* 9: 59. [\[CrossRef\]](#)
- Rudyanto, Rudyanto, Rudy Pramono, and Juliana Juliana. 2021. Perception of Knowledge of the Risk of the COVID-19 Pandemic Regarding Touring Intentions and Tourism Travel Recommendations. *Journal of Environmental Management and Tourism* 12: 929. [\[CrossRef\]](#)
- Ruiz-Sancho, Salvador, Maria José Viñals, Lola Teruel, and Marival Segarra. 2021. Security and Safety as a Key Factor for Smart Tourism Destinations: New Management Challenges in Relation to Health Risks. In *Culture and Tourism in a Smart, Globalized, and Sustainable World*. Springer Proceedings in Business and Economics. Edited by Vicky Katsoni and Ciná van Zyl. Cham: Springer International Publishing, pp. 511–22. [\[CrossRef\]](#)
- Sánchez-Cañizares, Sandra M., L. Javier Cabeza-Ramírez, Guzmán Muñoz-Fernández, and Fernando J. Fuentes-García. 2021. Impact of the Perceived Risk from Covid-19 on Intention to Travel. *Current Issues in Tourism* 24: 970–84. [\[CrossRef\]](#)
- Shahzad, Syed Jawad Hussain, Thi Hong Van Hoang, and Elie Bouri. 2022. From Pandemic to Systemic Risk: Contagion in the U.S. Tourism Sector. *Current Issues in Tourism* 25: 34–40. [\[CrossRef\]](#)
- Shneider, Alexandra, Tatiana Kudryavtseva, and Igor Dukeov. 2020. Cross-Border Cooperation as a Factor in Increasing the Efficiency of Small and Medium-Sized Enterprises of St. Petersburg. In *Proceedings of the International Scientific Conference—Digital Transformation on Manufacturing, Infrastructure and Service*. Saint Petersburg: ACM, pp. 1–7. [\[CrossRef\]](#)
- Sikarwar, Ekta. 2021. Time-Varying Foreign Currency Risk of World Tourism Industry: Effects of COVID-19. *Current Issues in Tourism* 24: 887–91. [\[CrossRef\]](#)
- Škare, Marinko, Domingo Riberio Soriano, and Małgorzata Porada-Rochoń. 2021. Impact of COVID-19 on the Travel and Tourism Industry. *Technological Forecasting and Social Change* 163: 120469. [\[CrossRef\]](#) [\[PubMed\]](#)
- Tanina, Anna, Evgeny Konyshchev, and Kamilya Tsahaeva. 2020. Agritourism Development Model in Digital Economy. In *Proceedings of the 2nd International Scientific Conference on Innovations in Digital Economy: SPBPU IDE-2020*. Saint Petersburg: ACM, pp. 1–6. [\[CrossRef\]](#)
- Teeroovengadam, Viraiyan, Boopen Seetanaah, Eric Bindah, Arshad Pooloo, and Isven Veerasawmy. 2021. Minimising Perceived Travel Risk in the Aftermath of the COVID-19 Pandemic to Boost Travel and Tourism. *Tourism Review* 76: 910–28. [\[CrossRef\]](#)
- Toroptysev, E. L., A. S. Marahovskiy, and A. V. Babkin. 2019. Complex Modeling of the Economic Systems Stability. *IOP Conference Series: Earth and Environmental Science* 272: 32175. [\[CrossRef\]](#)
- Tseng, Kuan-Chieh, Hsiao-Hsien Lin, Jan-Wei Lin, I-Shen Chen, and Chin-Hsien Hsu. 2021. Under the COVID-19 Environment, Will Tourism Decision Making, Environmental Risks, and Epidemic Prevention Attitudes Affect the People's Firm Belief in Participating in Leisure Tourism Activities? *International Journal of Environmental Research and Public Health* 18: 7539. [\[CrossRef\]](#)
- Vidishcheva, Evgeniya, Yuriy Dreizis, Andrey Kopyrin, and Marina Gunare. 2020. Identifying the Risks Impacting on the Sustainable Development of a Tourism Area. Edited by W. Strielkowski, E. Animitsa and E. Dvoryadkina. *E3S Web of Conferences* 208: 5018. [\[CrossRef\]](#)
- Villacé-Molinero, Teresa, Juan José Fernández-Muñoz, Alicia Orea-Giner, and Laura Fuentes-Moraleda. 2021. Understanding the New Post-COVID-19 Risk Scenario: Outlooks and Challenges for a New Era of Tourism. *Tourism Management* 86: 104324. [\[CrossRef\]](#)
- Volodin, Aleksandr, Maxim Ivanov, Mikhail Djaneldize, and Aleksandr Sokolitsyn. 2019. An Analytical Model of Economic Inequality in the Russian Regions and Its Correlation with the Global Trend in the Digital Economy. In *SPBPU IDE '19: Proceedings of the 2019 International SPBPU Scientific Conference on Innovations in Digital Economy*. New York: Association for Computing Machinery, pp. 1–4. [\[CrossRef\]](#)
- Wang, Xin, Ivan Ka Wai Lai, Quan Zhou, and Yu He Pang. 2021. Regional Travel as an Alternative Form of Tourism During the COVID-19 Pandemic: Impacts of a Low-Risk Perception and Perceived Benefits. *International Journal of Environmental Research and Public Health* 18: 9422. [\[CrossRef\]](#)
- Woosnam, Kyle Maurice, Zachary Russell, Manuel Alector Ribeiro, Tara J. Denley, Camila Rojas, Erin Hadjidakis, Joseph Barr, and Jackson Mower. 2021. 'Residents' Pro-Tourism Behaviour in a Time of COVID-19. *Journal of Sustainable Tourism* 30: 1858–77. [\[CrossRef\]](#)
- Wu, Chien-Hung. 2021. A Study on the Current Impact on Island Tourism Development under COVID-19 Epidemic Environment and Infection Risk: A Case Study of Penghu. *Sustainability* 13: 10711. [\[CrossRef\]](#)
- Xu, Linlin, Li Cong, Geoffrey Wall, and Hu Yu. 2021. Risk Perceptions and Behavioral Intentions of Wildlife Tourists During the COVID-19 Pandemic in China. *Journal of Ecotourism*, 1–20. [\[CrossRef\]](#)
- Zhu, Hui, and Fumin Deng. 2020. How to Influence Rural Tourism Intention by Risk Knowledge During COVID-19 Containment in China: Mediating Role of Risk Perception and Attitude. *International Journal of Environmental Research and Public Health* 17: 3514. [\[CrossRef\]](#) [\[PubMed\]](#)

## Article

# Uncertainty Analysis of Business Interruption Losses in the Philippines Due to the COVID-19 Pandemic

Joost R. Santos <sup>1,\*</sup>, John Frederick D. Tapia <sup>2</sup>, Albert Lamberte <sup>3</sup>, Christine Alyssa Solis <sup>3</sup>, Raymond R. Tan <sup>2</sup>, Kathleen B. Aviso <sup>2</sup> and Krista Danielle S. Yu <sup>3</sup>

<sup>1</sup> Department of Engineering Management and Systems Engineering, George Washington University, Washington, DC 20052, USA

<sup>2</sup> Department of Chemical Engineering, De La Salle University, Manila 0922, Philippines

<sup>3</sup> School of Economics, De La Salle University, Manila 0922, Philippines

\* Correspondence: joost@gwu.edu

**Abstract:** In this study, we utilize an input–output (I–O) model to perform an ex-post analysis of the COVID-19 pandemic workforce disruptions in the Philippines. Unlike most disasters that debilitate physical infrastructure systems, the impact of disease pandemics like COVID-19 is mostly concentrated on the workforce. Workforce availability was adversely affected by lockdowns as well as by actual illness. The approach in this paper is to use Philippine I–O data for multiple years and generate Dirichlet probability distributions for the Leontief requirements matrix (i.e., the normalized sectoral transactions matrix) to address uncertainties in the parameters. Then, we estimated the workforce dependency ratio based on a literature survey and then computed the resilience index in each economic sector. For example, sectors that depend heavily on the physical presence of their workforce (e.g., construction, agriculture, manufacturing) incur more opportunity losses compared to sectors where workforce can telework (e.g., online retail, education, business process outsourcing). Our study estimated the 50th percentile economic losses in the range of PhP 3.3 trillion (with telework) to PhP 4.8 trillion (without telework), which is consistent with independently published reports. The study provides insights into the direct and indirect economic impacts of workforce disruptions in emerging economies and will contribute to the general domain of disaster risk management.

**Keywords:** Leontief model; Dirichlet distribution; uncertainty analysis; workforce; disaster; pandemic

**Citation:** Santos, Joost R., John Frederick D. Tapia, Albert Lamberte, Christine Alyssa Solis, Raymond R. Tan, Kathleen B. Aviso, and Krista Danielle S. Yu. 2022. Uncertainty Analysis of Business Interruption Losses in the Philippines Due to the COVID-19 Pandemic. *Economics* 10: 202. <https://doi.org/10.3390/economics10080202>

Academic Editor: Edward C. Hoang

Received: 27 July 2022

Accepted: 15 August 2022

Published: 19 August 2022

**Publisher's Note:** MDPI stays neutral with regard to jurisdictional claims in published maps and institutional affiliations.



**Copyright:** © 2022 by the authors. Licensee MDPI, Basel, Switzerland. This article is an open access article distributed under the terms and conditions of the Creative Commons Attribution (CC BY) license (<https://creativecommons.org/licenses/by/4.0/>).

## 1. Introduction

Outbreaks of endemic diseases occur seasonally. Nonetheless, albeit relatively rare, severe epidemics that encompass large geographic areas and with high transmission rates—known as pandemics—have been well documented in the past. Early in the 20th century, the 1918 H1N1 pandemic nicknamed as the “Spanish Flu” became one of the deadliest disasters in modern times, killing more than 50 million people worldwide (Taubenberger and Morens 2006). Furthermore, mild to moderate pandemics occurred thereafter such as the 1952 H2N2, 1968 H3N2, and the more recent 2009 H1N1pdm2009 (Centers for Disease Control and Prevention 2018).

In 2007, the World Health Organization (WHO) issued a statement that emphasized the urgency of a coordinated effort amongst the global scientific community to prepare for and combat the risks associated with new infections (WHO 2007). Prior to the COVID-19 pandemic<sup>1</sup>, the current generation had not experienced a disaster of similar magnitude as the 1918 Spanish Flu. Indeed, we became firsthand witnesses to the complex consequences of COVID-19 such as mortalities, exceedance of healthcare capacity, and economic collapse, which punctuated the clear and present threat of pandemics. This has resulted in port closures and lockdowns, which have caused major supply chain disruptions whose impacts cross geographical boundaries (Yu and Aviso 2020). Furthermore, the transmission rate and severity of viral outbreaks are fraught with uncertainties. Increased burden on the

healthcare sector arises as frontliners have heightened exposure that can worsen the sector's inoperability (El Haimar and Santos 2015). Coupled with their ability to mutate and evade vaccination efforts, the recovery from a pandemic can be a complex and daunting effort (Orsi and Santos 2010).

For novel diseases, non-pharmaceutical intervention (NPI) measures are implemented in the absence of vaccines. The three major categories of NPI measures are containment, suppression, and mitigation. Containment is the ability to detect the infected individuals and separate them from the general population. Suppression, on the other hand, refers to measures that can reduce the reproduction number<sup>2</sup> to a value lower than 1, which may be achieved via business and school closures, travel restrictions, and lockdowns, among others. Finally, mitigation measures are the ones directly associated with the "flatten the curve" concept (Centers for Disease Control and Prevention 2007, 2017), which are also referred to as the 3Ws of mitigation—wash your hand, watch your distance, wear your personal protective equipment (PPE). Many studies have assessed both the efficacy of various NPI measures in reducing and delaying the impact of infections, as well as the unwanted adverse effects associated with mental health and infringement of personal liberties (Ferguson et al. 2020; Huzar 2020; James et al. 2020; Pueyo 2020).

Unlike most disasters where the direct damage is on physical infrastructure and the natural environment, the impact of pandemics is concentrated on people. The workforce is the lifeblood of any society, and massive disruptions to the workforce will immediately translate to the inoperability of critical infrastructure systems (Santos et al. 2014a). Hence, although pandemics do not render direct damage to physical systems, the consequences can be as debilitating as manmade disasters (Santos 2020a). In this paper, the focus of the analysis is on workforce disruptions attributable to NPI measures like lockdowns, business closures, and travel bans. Indeed, disasters like pandemics can lead to "forced" absenteeism because physical access to places of work is curtailed, or worse, completely restricted. In addition, workforce absenteeism can also be caused by workers getting sick themselves or providing care to sick family members, thus, requiring them to quarantine. Because of the significant impact triggered by workforce disruptions, government agencies such as the US Department of Labor (2020) have proposed policy recommendations to help reduce the subsequent economic losses. For example, teleworking (or "working from home") has provided an opportunity for sectors to continue their operations amid the pandemic. The availability of infrastructure and the nature of jobs allows for teleworking. Furthermore, some sectors have creatively leveraged information technology to maintain their capability to deliver goods and services virtually to lessen the impact of workforce disruptions. The pandemic has fast-tracked the adoption of teleworking across different jobs and sectors. Prior to the pandemic, the percentage of employees who were able to telework ranged from only 2 to 20 percent varying across countries, occupations, and sectors (Messenger 2019). However, the onset of the pandemic has led to a surge in teleworking. In the EU, 39.6% of paid work was conducted from the employees' homes and 46% had never teleworked prior to the pandemic (Eurofound 2020).

The primary contribution of this article is to model and evaluate the positive impact of teleworking and their associated economic benefits. In particular, the focus of this paper is to evaluate the benefits of teleworking on the continuity of operations across various sectors. The subsequent sections of this article are organized as follows. In Section 2, the methodology for modeling of workforce disruptions using input–output (I–O) modeling is discussed, as well as the use of Dirichlet distributions to model the uncertainty of the I–O parameters. The relevant data sources are also discussed in Section 2. In Section 3, we perform simulations of various telework scenarios and evaluate the resulting distribution of economic losses. The results are further discussed in Section 4. Finally, the conclusions of the paper and other reflections for future consideration are presented in Section 5.

## 2. Materials and Methods

### 2.1. Overview of Pandemic Impact Modeling

Pandemic and disaster risk management encompass a wide range of spatial and temporal dimensions (Okuyama and Santos 2014). However, identifying the optimal model for disaster risk analysis tends to be constrained by the availability of quality data, limitations of quantitative techniques, and interpretation of the results (Albala-Bertrand 1993). Santos et al. (2014a) introduced the WEIGHT framework (Workforce, Economy, Infrastructure, Geography, Hierarchy, and Time) to examine critical factors affecting disaster risk assessment and management. As the nature of international trade entails an interconnected economy, countries have become more vulnerable to foreign shocks.

COVID-19 has brought about global economic contraction due to a decline in consumption, disrupted global supply chain and production, business closures, and loss of work, causing an increase in the number of people living in extreme poverty with 3.3 billion workers worldwide at risk of losing their jobs (WHO 2020). Haleem et al. (2020) categorized the impact of the pandemic into three areas: healthcare, economic, and social. Other than the direct effect of the morbidity and mortality of the disease, the medical system is overstretched and highly burdened due to the overwhelming number of cases within a short period of time. Non-COVID patients have become neglected as healthcare professionals become understaffed due to exposure or quarantine measures. The medical supply chain was also disrupted due to stringent lockdown measures implemented both domestically and globally. The impact on the economy manifests in the reduced consumption of goods and disrupted global supply chain network. Lastly, the disruption to the social aspect includes the imposed social distancing measures, leading to the closure of social spaces such as restaurants, malls, entertainment areas, travel restrictions, and stalled service sector.

Previous studies have examined the impact of pandemics, and provided optimal intervention strategies that minimize economic losses, yet save thousands of lives. Ginsberg et al. (2009) emphasized the need for early detection and response to mitigate the impact of both season and pandemic influenza. Eichenbaum et al. (2021) identified a trade-off between negative short-run economic outlook and the health of the population, where ending containment early (before 44 weeks) can create a surge in infection rates while starting containment too late (after 33 weeks) can cause the death of up to 0.4% of the initial population. Ferguson et al. (2006) determined that intervention measures such as rapid case isolation can reduce cumulative attack rates by 7% (if 90% of cases are isolated), while the implementation of border controls can only delay the spread by three to six weeks if imported infections were reduced by over 99%. Lastly, a combination of personal behavioral change and government intervention would be the optimal strategy to mitigate the spread of the pandemic, emphasizing the role of the individual to conduct self-isolation, social distancing, and to seek remote medical assistance (Anderson et al. 2020). Governments may also impose travel restrictions and conduct rigorous contact tracing to ensure spread containment.

Dingel and Neiman (2020) argued that low-income economies tend to have fewer jobs that can be conducted remotely or at home. Governments implemented NPI measures to mitigate the spread of infection before the use of vaccines became widespread. NPI measures are done through the combination of containment, suppression, and mitigation measures (Santos 2020a). However, such measures may result in forced absenteeism because of mobility restrictions such as lockdowns or lack of transportation (Santos 2020b). Sectors reliant on migrant workers were hit particularly hard (Foong et al. 2022).

Several studies on post-disaster workforce unavailability exposed the adverse economic impact of disruptions. Orsi and Santos (2010) translated the effect of workforce unavailability as a measure of sector productivity disruption in the state of Virginia. Using three potential attack rates (15%, 25%, and 35%), the expected value of economic losses would be USD 4.6 billion, USD 7.7 billion, and USD 10.8 billion, respectively. Chen et al. (2021) examined the trade-off between economic losses due to inoperability, lockdown duration, and averted infections and deaths. In an unmitigated scenario (no lockdown or

NPI measures), economic losses were highly reduced but resulted in 100 million infections and a hundred thousand mortalities. On the other hand, a lockdown scenario of 45 days with 90% compliance rate will result in an economic loss of about USD 3.4 trillion but will save over 110,000 lives and mitigate the infection of 115 million individuals.

The unpredictable nature of the pandemic has led to governments implementing varying levels of mobility restrictions over an extended period of time that resulted in persistent inoperability in the economy (Yu et al. 2020b). The COVID-19 pandemic has forced an increased adoption of alternative working arrangements globally to reduce the spread of the virus. In the United States, 35.2% of the workforce were working from home by May 2020 in contrast to 8.2% in February (Bick et al. 2020). There was also an increase in work from home arrangements in the EU. Eurofound (2020) launched a survey and found that more than 48% of its respondents who were categorized as employees were now partially working from home, while 34% worked exclusively from home. In the Philippines, work-from-home (WFH), or telework arrangements were adapted by businesses if their line of work allows their employees to do so. Gaduena et al. (2022) estimated that only 25.7% of occupations in the Philippines are teleworkable. Although there was a swift adoption of such measure to those that have the capability to do so, some jobs cannot be performed remotely (Gaduena et al. 2022). Further, Gaduena et al. (2022) identified that most of the occupations that can support teleworkable jobs are typically found in sectors that have a low share of the country's total employment (i.e., sectors that require at least undergraduate degrees). The Organization for Economic Co-operation and Development (OECD) (OECD 2020) also states that most teleworkable jobs require highly skilled workers. Generalao (2021) also made a similar argument, such that industries that employ more educated individuals can experience the benefits of technological advances. On the other hand, those occupations that require lower levels of education, such as low- and medium-skilled laborers, are considered non-teleworkable (Gaduena et al. 2022; OECD 2020). Telework arrangements brought about an unprecedented demand surge for electronics. A prolonged shortage in essential technology metals will affect production of equipment necessary for telework (Yu et al. 2020a). Thus, persistent supply chain disruptions can affect teleworkability in the long run.

## 2.2. Economic Input–Output Model

The input–output (I–O) model provides a mathematical framework to model the interdependencies among economic sectors that comprise an economy (Leontief 1936). It has been used for numerous applications involving analysis and forecasting and is considered as a standard economic tool in most countries (Miller and Blair 2009). I–O models use systems of linear equations to capture the network-like structure of interlinked economic structures. This feature makes this approach particularly useful for studying the changes in production and consumption of interdependent economic sectors as a result of network ripple effects. The basic I–O model can also serve as the basis for more sophisticated models. Examples include mathematical programming extensions as well as computable general equilibrium (CGE) models that relax the strict assumption of the Leontief production function (Miller and Blair 2009).

The basic I–O model may be written as follows:

$$x = Ax + y \quad (1)$$

where  $A$  is the matrix of technical coefficients,  $x$  is the vector of total sector outputs, and  $y$  is the vector of sector final demands. Equation (1) shows that the total output must meet the combined intermediate and final demands. In conventional I–O applications, these flows are given in terms of monetary value. The coefficients of  $A$  reflect the average state of production technology used in the system's sectors. Their proportions are assumed to be fixed to reflect a Leontief production function that does not allow for substitution among inputs. This restrictive assumption is generally considered as acceptable for typical

applications of I–O models, which are understood to provide snapshots of the state of the economies that they represent. Rearranging Equation (1) gives:

$$x = (I - A)^{-1}y \quad (2)$$

where  $(I - A)^{-1}$  is the Leontief inverse. In this form, the I–O model can be readily used to compute production levels associated with any given final demand scenario.

The basic I–O model has also been extended to account for the flow of inoperability through economic or infrastructure networks (Haimes and Jiang 2001). Inoperability is a dimensionless metric of the degree of system failure, with a value ranging from 0 for a system at normal state to a value of 1 for a system in a state of total failure. The original physical definition of inoperability was modified by Santos and Haimes (2004) to allow inoperability I–O models (IIM) to be calibrated using published economic data. In such applications, inoperability quantifies the relative or fractional drop in economic activity (Santos 2006). The IIM formulation based on demand disruption is shown in Equation (3):

$$q = A^*q + c^* \quad (3)$$

where  $A^*$  is the interdependency matrix,  $c^*$  is the sector demand disruption vector, and  $q$  is the sector inoperability vector. Matrix  $A^*$  can be determined from the baseline state of the economy being analyzed (Santos and Haimes 2004). Note that this model is structurally analogous to the basic I–O model, and can also be rearranged as follows:

$$q = (I - A^*)^{-1}c^* \quad (4)$$

where  $(I - A^*)^{-1}$  is analogous to the Leontief inverse, and acts as a multiplier that quantifies the amplification effect of an economic system on an initial input disruption ( $c^*$ ) to yield the sectoral interoperability ( $q$ ). This demand-reduction form of the IIM model was first used to analyze the economic ripple effects of the September 11 terrorist attacks in the United States (Santos and Haimes 2004). A two-part review on IIM was subsequently published, focusing on fundamentals (Haimes et al. 2005a) and applications (Haimes et al. 2005b), respectively. In addition to these early uses of IIM, more recent examples of disruptive events modelled with IIM in the previous decade include earthquakes and tsunamis (MacKenzie et al. 2012), cyberterrorist attacks (Ali and Santos 2015), droughts (Santos et al. 2014b), crop failure due to infestation (Aviso et al. 2015), and influenza epidemics (Santos et al. 2013).

The basic I–O model and IIM can be used in parallel to analyze the effects of disasters and other disruptive events, since they reflect different aspects of the system. These two metrics thus generally lead to different priority rankings of economic sectors (Santos et al. 2013). For example, large economic sectors can experience high levels of economic loss even at relatively low inoperability. Conversely, small sectors may experience seemingly small economic losses even at high levels of inoperability. This distinction has important uses for supporting policy decisions. Economic loss estimates from the basic I–O model can be interpreted directly in terms of social welfare implications. On the other hand, inoperability reflects the actual extent of loss suffered by a given sector relative to its normal state. Since economic sectors are the aggregation of multiple private businesses, inoperability can more accurately reflect the collective damage done to these entities (e.g., a wave of bankruptcies in a given sector may hamper its ability to recover from a transient crisis). The inoperability metric can also be linked to shifts in economic structure leading to improved resilience (Okuyama and Yu 2019).

### 2.3. Uncertainty Analysis

In the field of probabilistic risk analysis (PRA), it is commonplace to estimate a consequence metric from a disaster as a range or as a point estimate with an associated confidence interval. Indeed, Kaplan and Garrick (1981) formulated the triplet of questions



in PRA that explicitly contains the element of uncertainty. These questions are: (i) “What can go wrong?”, (ii) “What is the likelihood?”, and (iii) “What are the consequences?”.

Uncertainty analysis is a broad subject area, encompassing the two general categories of uncertainty—aleatory (statistical variability or randomness) and epistemic (lack of knowledge). In this paper, the emphasis is on the uncertainty of the model parameters of the I–O model, which was discussed in the previous section. In particular, we will model the effects of the I–O technical coefficient matrix (denoted by  $A$  in Equation (1)).

In the domain of I–O modeling and analysis, several papers have emphasized the importance of conducting uncertainty analysis. Rose (2004) argues that the use of a deterministic point estimate to discuss the result of an analysis reflects the exaggeration of certainty and will most likely be erroneous. Furthermore, quoting from Gerking (1976): “It is commonplace in I–O analysis to interpret [the static I–O equation] as a deterministic or exact forecast. However, to contend that this forecast will come true with certainty is optimism to a fault”. As a corollary to such arguments, deterministic modeling estimates may lead to faulty policies due to the illusion of certainty that they create.

This paper proposes the use of Dirichlet distribution to model the uncertainties associated with the elements of the I–O matrix. The Dirichlet distribution can be thought of as an extension of the Beta distribution. When modeling a set of variable proportions that add up to 1, the appropriate distribution to use is the Dirichlet distribution. As a matter of fact, several papers have explicitly used the Beta and Dirichlet distributions to model uncertainty of the I–O coefficients (see, for examples, Jansen 1994; Ten Raa and Rueda-Cantuche 2007; Dietzenbacher 2006).

The probability density function of the Beta distribution is as follows, where  $x$  is the random variable, and the Greek letters are the standard notation for the Beta distribution parameters:

$$f(x; \alpha, \beta) = \frac{\Gamma(\alpha + \beta)}{\Gamma(\alpha)\Gamma(\beta)} x^{\alpha-1} (1-x)^{\beta-1} \quad (5)$$

$$0 \leq x \leq 1 \text{ and } \alpha, \beta > 0$$

The Beta distribution is commonly used to model a proportion. For example, if we look at the proportion of the manufacturing sector with respect to the total gross domestic product (GDP), such proportion can change from year to year and hence can be modeled as a Beta distribution. The Beta distribution can only handle one proportion at a time as a random variable. There are cases where it is desirable to model multiple proportions that add up to one. For example, consider the Philippine I–O table where each column comprises of 16 sectors + value added (see Supplementary Materials). Each column can be normalized with respect to the total production output (i.e., production requirements of the 16 sectors + value added). The resulting normalized column comprising of 17 elements will necessarily add up to 1. Hence, the elements of a column of the I–O matrix can be simultaneously modeled as a Dirichlet distribution, whose formulations are shown below.

The probability density function of the Dirichlet distribution is as follows, where  $x_i$  are the Dirichlet random variables,  $\alpha_i$  are the associated Dirichlet parameters, and  $\Gamma(\cdot)$  is the Gamma function:

$$f(x; \alpha) = \frac{\Gamma(\sum_{i=1}^k \alpha_i)}{\Gamma(\prod_{i=1}^k \alpha_i)} \prod_{i=1}^{k-1} (x_i)^{\alpha_i-1} \left(1 - \sum_{i=1}^{k-1} x_i\right)^{\alpha_k-1} \quad (6)$$

$$0 \leq x_i \leq 1 \text{ and } \alpha_i > 0 \text{ for } i = 1, 2, \dots, k$$

The general formulation in the previous equation can be rewritten by letting  $\alpha_0 = \sum_{i=1}^k \alpha_i$ .

$$f(x; \alpha) = \frac{\Gamma(\alpha_0)}{\Gamma(\prod_{i=1}^k \alpha_i)} \prod_{i=1}^{k-1} (x_i)^{\alpha_i-1} \left(1 - \sum_{i=1}^{k-1} x_i\right)^{\alpha_k-1} \quad (7)$$

Each proportion  $x_i$  in the above Dirichlet distribution can be modeled separately as a marginal distribution of a Gamma distribution variable  $y_i$ , which follows the following formula.

$$f(y_i; \alpha_i, \alpha_0 - \alpha_i) = \frac{\Gamma(\alpha_0)}{\Gamma(\alpha_i)\Gamma(\alpha_0 - \alpha_i)} y_i^{\alpha_i - 1} (1 - y_i)^{\alpha_0 - \alpha_i - 1} \tag{8}$$

To derive the values of the Dirichlet variable  $x_i$  from the Gamma variable  $y_i$ , the following algorithm is used.

**Step 1:** For  $i = 1, 2, \dots, k$ , draw a random number,  $y_i$ , from a Gamma distribution with parameters  $\Gamma(\alpha_i, 1)$ , where:

$$\Gamma(\alpha_i, 1) = \frac{y_i^{\alpha_i - 1} e^{-y_i}}{\Gamma(\alpha_i)} \tag{9}$$

**Step 2:** Normalize the realizations from Step 1 to produce the Dirichlet realizations.

$$x_i = \frac{y_i}{\sum_{i=1}^k y_i} \tag{10}$$

Figure 1 shows the multiple columns of an I–O matrix, where each column adds up to 1. Each column can be modeled as a Dirichlet distribution using the previous formulations and the foregoing simulation algorithm.

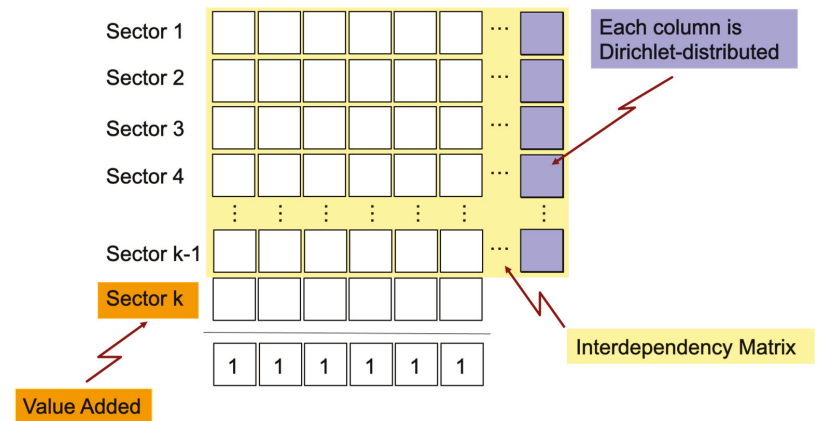


Figure 1. Depiction of an I–O matrix where each column is modeled as a Dirichlet distribution.

2.4. Data Sources

2.4.1. Input–Output Data (2000, 2006, 2012, 2018)

This study will use the case of the Philippines to illustrate the use of 2000 (National Statistical Coordination Board 2006a), 2006 (National Statistical Coordination Board 2006b), 2012 (Philippine Statistics Authority 2017) and 2018 (Philippine Statistics Authority 2018) Philippine Input–Output Tables. The I–O tables for the different years were re-specified into 16-sector tables that account for one agriculture sector, four industrial sectors and eleven services sectors. Table 1 provides details on the sector disaggregation of the input–output tables that is adapted in the study.

**Table 1.** Sector classification.

Sector Code	Sector
S1	Agriculture, forestry, and fishing
S2	Mining and quarrying
S3	Manufacturing
S4	Electricity, steam, water and waste management
S5	Construction
S6	Wholesale and retail trade; repair of motor vehicles and motorcycles
S7	Transportation and storage
S8	Accommodation and food service activities
S9	Information and communication
S10	Financial and insurance activities
S11	Real estate and ownership of dwellings
S12	Professional and business services
S13	Public Administration and Defense; Compulsory social security
S14	Education
S15	Human health and social work activities
S16	Other services

#### 2.4.2. Workforce Disruption Scenarios

The COVID-19 pandemic has resulted in significant workforce disruptions across practically every sector of the economy. In this paper, we performed a literature search to determine the workforce disruption percentage in the Philippines. While the disruption fluctuated during the pandemic as influenced by the varying levels of lockdown scenarios and the associated business closures (see Yu et al. 2020a), we will assume an average annualized workforce disruption for simplicity. There were various estimates of workforce disruptions in the Philippines, but the data that have been specifically used in this paper were based on the detailed report of the International Labor Organization (ILO). In its report, it states that: “One quarter of total employment in the Philippines is likely to be disrupted by the impact of COVID-19 on the economy and labour market, either through decreased earnings and working hours or complete job loss” (ILO 2020).

Using the ILO data, given a 25% general workforce disruption, the next step is to determine the workforce dependence of each sector. A labor-intensive sector that is heavily reliant on its workforce is likely to be more severely affected than a sector that is relatively more automated. In the Philippine I–O tables, the sector-specific workforce dependence can be established from the “value added” portion of the data, notably the “compensation of employees”. If the total workforce compensation expenditure of a sector is denoted by  $w_i$ , and its total production output is denoted by  $x_i$ , then the ratio  $w_i/x_i$  gives an estimate of the labor dependence of that sector. Table 2 gives the sector-specific workforce dependence ratios based on 2018 Philippine I–O data.

Hence, the 25% workforce disruption percentage obtained from the ILO is further adjusted to account for the above sector-specific workforce dependence. Furthermore, the baseline scenario assumed in this paper is that the sectors are not able to telework. This baseline is simulated in this paper to determine the savings realized in contrast to the scenario where each sector’s workforce disruption rate is further reduced depending on the ability of each sector to telework. The description of such an approach as well as the actual telework multipliers used in the study is described in the next section.

**Table 2.** Ratio of Compensation of Employees with Production Output (both in million PhP<sup>3</sup>).

Sector Code	Sector	$w_i$	$x_i$	$w_i/x_i$
S1	Agriculture, forestry, and fishing	580,692	3,460,982	17%
S2	Mining and quarrying	23,593	245,169	10%
S3	Manufacturing	959,037	10,938,541	9%
S4	Electricity, steam, water and waste management	92,438	897,255	10%
S5	Construction	576,094	3,008,314	19%
S6	Wholesale and retail trade; repair of motor vehicles and motorcycles	975,807	4,667,591	21%
S7	Transportation and storage	241,220	1,737,302	14%
S8	Accommodation and food service activities	127,419	1,074,371	12%
S9	Information and communication	156,760	1,051,165	15%
S10	Financial and insurance activities	427,069	2,743,564	16%
S11	Real estate and ownership of dwellings	56,837	1,530,595	4%
S12	Professional and business services	725,200	2,008,912	36%
S13	Public Administration and Defense; Compulsory social security	612,367	1,265,078	48%
S14	Education	559,598	857,562	65%
S15	Human health and social work activities	84,287	460,131	18%
S16	Other services	98,666	592,942	17%

#### 2.4.3. Telework Data

This study adapts the weighted average teleworkability of occupations by major industry groups in the Philippines based on Generalalao (2021). The major industry group were then aggregated based on the sector classification specified in Table 1. Since this study considered the proportion of the occupations that are not teleworkable (a dimensionless measure), Table 3 presents the information on non-teleworkable jobs,  $(1 - T_i)$ , where  $T_i$  is the proportion of teleworkable jobs for sector  $i$  as adapted from Generalalao (2021).

**Table 3.** Proportion of non-teleworkable occupations by major industry group.

Sector Code	Sector	$(1 - T_i)$
S1	Agriculture, forestry, and fishing	0.9191
S2	Mining and quarrying	0.8744
S3	Manufacturing	0.8257
S4	Electricity, steam, water and waste management	0.7252
S5	Construction	0.9616
S6	Wholesale and retail trade; repair of motor vehicles and motorcycles	0.6058
S7	Transportation and storage	0.8038
S8	Accommodation and food service activities	0.8332
S9	Information and communication	0.3571
S10	Financial and insurance activities	0.2264
S11	Real estate and ownership of dwellings	0.4763
S12	Professional and business services	0.4987
S13	Public Administration and Defense; Compulsory social security	0.6366
S14	Education	0.4327
S15	Human health and social work activities	0.7009
S16	Other services	0.7096

### 3. Results

#### 3.1. Processing the I–O Data for Uncertainty Analysis

To be able to estimate the Dirichlet parameters, the values in the I–O matrix were normalized to compute for the shares for each sector. To get the shares for each sector, we first calculated the total input of each sector,  $S_{it}$  for each sector  $i$  for each year  $t$  and it includes the value added,  $VA_{it}$  (see Equation (11)). We let  $I_{it}$  be the intermediate input of sector  $i$  and at year  $t$ . The value added,  $VA_{it}$ , includes: (1) Compensation of Employees;

(2) Consumption of Fixed Capital; (3) Indirect Taxes less subsidies; and (4) Operating Surplus<sup>4</sup>. There are 16 sectors in the Philippine I–O table and the study uses the I–O tables for the years 2000, 2006, 2012, and 2018.

$$S_{it} = \sum_{i=1}^{16} I_{it} + \sum VA_{it} \tag{11}$$

To get the share of each intermediate input for each sector  $i$  at year  $t$ , we take the value of the sector’s intermediate input and divide it by the total input of each sector,  $S_{it}$  (see Equation (12)). The share of the value added is also calculated similarly as shown in Equation (13). The estimated shares are then used as the dataset for the uncertainty analysis and the Dirichlet parameters.

$$\text{Share of intermediate input of sector } i \text{ at year } t = \frac{I_{it}}{S_{it}} \tag{12}$$

$$\text{Share of value added of sector } i \text{ at year } t = \frac{\sum VA_{it}}{S_{it}} \tag{13}$$

### 3.2. Dirichlet Parameters

The statistical distribution of the values in the I–O matrix can be generated with beta or gamma distribution using the Dirichlet parameter  $\hat{\alpha}_{ij}$  and  $\hat{\beta}_{ij}$  using the following equations:

$$\alpha_{ij} = \mu_{ij} \left( \frac{\mu_{ij} - \mu_{ij}^2}{\sigma_{ij}^2} - 1 \right) \tag{14}$$

$$\beta_{ij} = (1 - \mu_{ij}) \left( \frac{\mu_{ij} - \mu_{ij}^2}{\sigma_{ij}^2} - 1 \right) \tag{15}$$

$$\hat{\alpha}_{ij} = \mu_{ij} (\alpha_{kj} + \beta_{kj}) \tag{16}$$

$$\hat{\beta}_{ij} = \sum_{i=1}^k \hat{\alpha}_{ij} - \hat{\alpha}_{ij} \tag{17}$$

where  $\mu_{ij}$  and  $\sigma_{ij}$  are the mean and standard deviation of the entry in the I–O matrix and  $\alpha_{kj}$  is generated using the following equation:

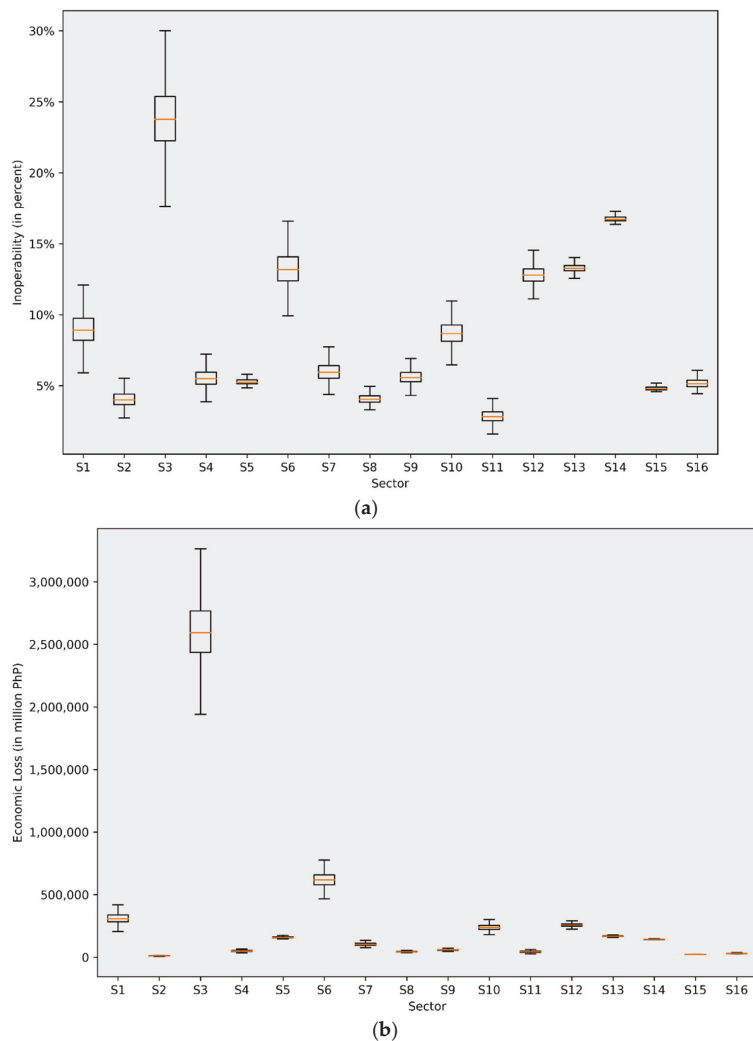
$$\alpha_{kj} = 1 - \sum_{i=1}^{k-1} \alpha_{ij} \tag{18}$$

Different realizations with the I–O matrix can be generated with beta distribution using the parameters  $\hat{\alpha}_{ij}$  and  $\hat{\beta}_{ij}$  or with Gamma distribution using  $\hat{\alpha}_{ij}$  with a scale of 1 and then normalization to be consistent with the property of the I–O matrix (see Supplementary Materials). Both distributions provide the same expected value and probability distribution. The generation of these parameters is implemented using Numpy’s gamma and beta sampling functions (random.gamma and random.beta) (Harris et al. 2020).

### 3.3. Description of Scenarios and Visualization of Results

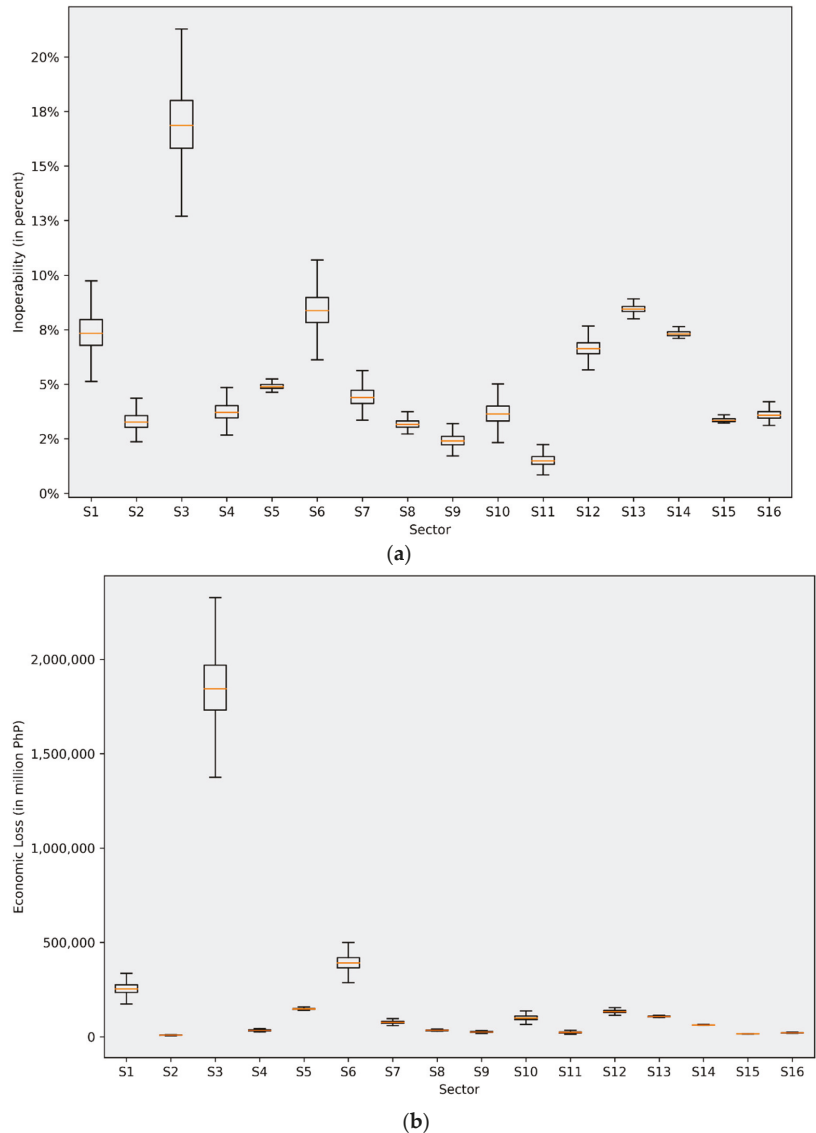
This study considers two scenarios: (1) no telework, and (2) with telework. Scenario 1 does not allow for telework in any sector. This means that the full impact of the initial disruption ( $c^*$ ) will ripple through the different sectors in the economy. Scenario 2 accounts for teleworkability of jobs in the Philippines based on Generalao (2021). With telework, the initial disruption ( $c^*$ ) is reduced by the proportion of jobs that are teleworkable, such that the initial disruption in Scenario 2 for each sector  $i$  is defined as  $c_i^* * (1 - T_i)$ , where  $T_i$  is the teleworkability index of sector  $i$ . On the other hand,  $c_i^*$  is the sector-specific workforce disruption, which is computed as the ILO’s 25% general workforce disruption multiplied with the sector-specific  $w_i / x_i$  ratio found on Table 2.

The losses from different simulation runs are computed based on different realizations of the I–O matrix; a boxplot can then be generated showing the uncertainty of these losses. Figure 2 shows the boxplots for the percent losses and output losses for 25% disruption to the general workforce. The plot shows that the largest loss is incurred in the manufacturing sector with around PhP 1.9 trillion to PhP 3.4 trillion followed by the wholesale and trade sector with PhP 500 billion to PhP 700 billion in losses. The plots also show that these two sectors show the highest variability in terms of economic losses. Both sectors maintain their ranks except if the highest loss of agricultural sector is compared with the lowest loss of the wholesale and trade sector. It shows that if the agricultural sector is affected by the workforce disruption worse than expected, it can incur losses comparable to other sectors. It is also evident in Figure 2 when the percentage loss in agricultural sector is higher than in wholesale and trade. The education sector has the second highest percentage loss to manufacturing and is one with the least variability among sectors.



**Figure 2.** Losses incurred to different sector due to 25% disruption in general workforce in terms of (a) percent losses and (b) actual economic loss assuming absence of telework performance.

Figure 3 shows the boxplots for the percent losses and output losses for 25% disruption considering the telework data. The actual losses are generally lower than that when the telework data are not considered, providing concrete evidence that teleworking as a resilience strategy is effective in curbing the economic losses relative to the baseline case (i.e., no telework scenario). The same trend is observed except for certain sectors such as the transportation sector, and education sector wherein the losses in the education sector are lower than the transportation sector if the telework performance is considered. The rank reverses when the telework data are not considered in the computation.



**Figure 3.** Losses incurred to different sectors due to 25% disruption in the general workforce in terms of (a) percent losses, and (b) actual economic loss considering the sector-specific telework data.

## 4. Discussion

### 4.1. Specific Findings on Philippine I–O Sectors

The results of the uncertainty analysis show how allowing telework in the 16 sectors presented has significantly decreased the estimated economic losses due to the COVID-19 pandemic in the Philippines. If the telework arrangements were not adopted, the estimates show that the country will have a substantial economic loss which is equivalent to PhP 4.89 trillion, or approximately USD 86.9 billion due to the lockdowns. All 16 sectors benefited from allowing the telework arrangement as the losses with telework was significantly decreased from PhP 4.89 trillion to PhP 3.3 trillion, or approximately USD 58.7 billion.

Three sectors benefitted the most from reducing the economic losses by allowing telework during the COVID-19 pandemic. The first sector, which is the manufacturing sector (S3), had the biggest difference between with and without telework, with the difference amounting to PhP 750 billion (USD 13.5 billion). It is expected, however, that out of all the sectors, the manufacturing sector will have the most losses since most of its economic activities require the physical presence of laborers. The second sector that also benefitted from allowing telework was the wholesale and retail trade (S6)<sup>5</sup>. The difference in economic loss between with and without telework is estimated at PhP 226 billion (USD 4 billion). The third sector that had significantly lower losses with the introduction of telework was the financial and insurance activities (S10). The estimated difference in the economic losses with and without telework is PhP 139 billion (USD 2.463 billion). Looking at the rest of the sectors, the trend is the same in which having telework has decreased the estimated economic losses due to the pandemic.

An interesting insight from the results is that there are non-teleworkable sectors, as classified by [Gadueno et al. \(2022\)](#) and [Generalao \(2021\)](#), that still benefitted indirectly from teleworking. These industries include agriculture, forestry, and fishing (S1), manufacturing (S3), wholesale and retail trade and repair of motor vehicles and motorcycles (S6), transportation and storage (S7), and public administration and defense and compulsory social security (S13). Although these sectors mostly require a physical presence, the estimates suggest that introducing telework can mitigate the economic losses due to the pandemic. This effect can be attributed to the use of teleworking arrangements both within these sectors, and in other sectors with which they have strong supply chain linkages.

### 4.2. Uncertainty Analysis

Tables 4–6 shows the comparison between economic losses in million PhP considering the 25th, 50th and 75th percentiles in the Dirichlet distribution for each sector. Policy makers can use these percentile estimates in accordance with their risk appetite. In all percentile points, most sectors such as the manufacturing, wholesale and trade, and agriculture sectors maintain their ranks whether the telework data are considered or not. Changes in the ranking can be observed at certain sectors when the percentile is changed. For instance, the larger variability in financial and insurance activities sector allows it to outrank the public administration and social security sectors when the losses are changed from the 50th to the 75th percentile. This change shows that variability should be considered in prioritizing certain sectors when workforce disruptions are experienced.

The results generated by the simulations are consistent and in the same order of magnitude as the estimates published by the National Economic and Development Authority. In particular, the agency has estimated the total economic losses associated with COVID-19 business interruptions and quarantines for the year 2020 to be at PhP 4.3 trillion (National Economic and Development Authority 2021). A case in point, our 25th percentile estimates (see Table 4) range from PhP 3.1 trillion (with telework) to PhP 4.6 trillion (without telework). Furthermore, our median estimates (see Table 5) range from PhP 3.3 trillion (with telework) to PhP 4.8 trillion (without telework). Finally, the 7th percentile estimates of economic losses in Table 6 range from PhP 3.5 trillion (with telework) to PhP 5.2 trillion (without telework). The total economic losses shown at the bottom of Tables 4–6 consistently capture the PhP 4.3 trillion estimate published by the National Economic and



Development Authority (2021), hence providing a validation of the model results generated in our simulations.

**Table 4.** Economic losses for different sectors based on the 25th percentile in the Dirichlet distribution.

Sector Code	Sector	No Telework	With Telework	Difference
S1	Agriculture, forestry, and fishing	282,719	234,678	48,041
S2	Mining and quarrying	8963	7389	1574
S3	Manufacturing	2,437,518	1,728,333	709,185
S4	Electricity, steam, water, and waste management	45,959	30,971	14,988
S5	Construction	154,412	144,782	9630
S6	Wholesale and retail trade; repair of motor vehicles and motorcycles	577,483	365,226	212,257
S7	Transportation and storage	96,076	71,497	24,579
S8	Accommodation and food service activities	41,300	32,588	8712
S9	Information and communication	55,598	23,287	32,311
S10	Financial and insurance activities	223,999	90,589	133,410
S11	Real estate and ownership of dwellings	38,782	20,281	18,501
S12	Professional and business services	248,541	128,356	120,185
S13	Public Administration and Defense; Compulsory social security	165,688	105,437	60,251
S14	Education	142,433	62,043	80,390
S15	Human health and social work activities	21,650	15,134	6516
S16	Other services	29,239	20,423	8816
Total		4,570,360	3,081,014	1,489,346

**Table 5.** Economic losses for different sectors based on the 50th percentile (median) in the Dirichlet distribution.

Sector Code	Sector	No Telework	With Telework	Difference
S1	Agriculture, forestry, and fishing	307,765	253,668	54,097
S2	Mining and quarrying	9804	7981	1823
S3	Manufacturing	2,599,304	1,847,460	751,844
S4	Electricity, steam, water, and waste management	49,449	33,269	16,180
S5	Construction	157,967	146,988	10,979
S6	Wholesale and retail trade; repair of motor vehicles and motorcycles	614,992	390,473	224,519
S7	Transportation and storage	102,952	76,081	26,871
S8	Accommodation and food service activities	43,406	33,846	9560
S9	Information and communication	58,663	25,070	33,593
S10	Financial and insurance activities	238,084	99,343	138,741
S11	Real estate and ownership of dwellings	43,137	22,751	20,386
S12	Professional and business services	256,613	133,108	123,505
S13	Public Administration and Defense; Compulsory social security	167,897	106,825	61,072
S14	Education	143,404	62,630	80,774
S15	Human health and social work activities	21,996	15,361	6635
S16	Other services	30,441	21,186	9255
Total		4,845,874	3,276,040	1,569,834

**Table 6.** Economic losses for different sectors based on the 75th percentile in the Dirichlet distribution.

Sector Code	Sector	No Telework	With Telework	Difference
S1	Agriculture, forestry, and fishing	337,089	276,171	60,918
S2	Mining and quarrying	10,799	8674	2125
S3	Manufacturing	2,780,086	1,972,136	807,950
S4	Electricity, steam, water, and waste management	53,585	35,977	17,608
S5	Construction	162,628	149,988	12,640
S6	Wholesale and retail trade; repair of motor vehicles and motorcycles	656,070	419,259	236,811
S7	Transportation and storage	111,320	81,573	29,747
S8	Accommodation and food service activities	46,200	35,549	10,651
S9	Information and communication	62,338	27,358	34,980
S10	Financial and insurance activities	254,440	109,449	144,991
S11	Real estate and ownership of dwellings	48,309	25,830	22,479
S12	Professional and business services	265,813	138,767	127,046
S13	Public Administration and Defense; Compulsory social security	170,319	108,397	61,922
S14	Education	144,715	63,465	81,250
S15	Human health and social work activities	22,499	15,700	6799
S16	Other services	31,966	22,234	9732
	Total	5,158,176	3,490,527	1,667,649

## 5. Conclusions

The COVID-19 pandemic has brought an unprecedented cascade of economic losses across the globe. The largest contributor to economic loss is attributable to workforce disruptions resulting from quarantines and business closures. Workforce disruptions subsequently led to significant direct and indirect ripple effects on the operation of the economic sectors. Several studies, even prior to the COVID-19 pandemic, already indicated that business interruptions during disasters were a top factor leading to economic losses. In this paper, we perform an ex-post analysis of the COVID-19 workforce disruptions in the Philippines. The aim is to estimate the workforce-induced economic losses for year 2020. Using a series of Philippine I–O data, we estimated the probability distributions of the model parameters to allow for uncertainty analysis in the estimates of economic losses. The simulation results are consistent with the official deterministic figure of 4.3 trillion PhP. Furthermore, a novel feature of this paper is the use of Dirichlet distributions to generate a range of economic losses (e.g., 25th, 50th, and 75th percentiles) for two scenarios: (i) an extreme case assuming no telework, and (ii) sector-specific telework analysis using estimates from previous studies. The advantage of uncertainty analysis is that it allows the presentation of results as a distribution, consistent with the argument that a fixed-point estimate often creates an illusion of precision, which can restrict the flexibility in resource allocation decisions. A range of estimates allows for the implementation of “what if” scenarios, which leads to a more holistic and robust policymaking.

Some of the highlights of the results in this paper are as follows: Intuitively, the magnitude of losses depends on the size of the sector (GDP), as well as the labor-dependence of the sectors. To wit, sectors that contribute highly to GDP were among the most affected sectors such as manufacturing, trade, agriculture, and construction, which happen to be among the highest contributors to the Philippine GDP. It has also been found that labor-dependent sectors with less telework index can be observed in the fractional loss (inoperability) rankings albeit their moderate contribution to the GDP, such as public administration, education, professional and business Services.

To conclude, current disaster management policies need to be enhanced to minimize the impact of pandemics and future disasters. The COVID-19 pandemic in particular has exposed challenges and constraints in socioeconomic and infrastructure systems. Nonpharmaceutical intervention measures could reduce the impact on the workforce, healthcare systems, and continuity of government. Measures like teleworking can have a significant

impact on the extent to which the pandemic curve can be flattened. The benefits of such arrangements were shown to also indirectly accrue to sectors that are not inherently suited to teleworking. Results from this paper can be used to determine the key sectors that are most impacted by the disaster and can be used to formulate policies to target sectors that contribute the most to the direct and ripple effects of indirect losses. These results can be generalized to other countries in preparation for future pandemics. Finally, the methodology for this paper can be adopted and extended for other disaster risk management studies, particularly those that affect the workforce more than the infrastructure.

**Supplementary Materials:** The 16-sector Philippine Input–Output Tables used in this study can be accessed through [10.6084/m9.figshare.20374587](https://doi.org/10.6084/m9.figshare.20374587). The Python code used for this study can be accessed in <https://github.com/fredtapia/IO-Dirichlet> (accessed on 17 August 2022).

**Author Contributions:** Conceptualization, J.R.S.; methodology, J.R.S., A.L. and J.F.D.T.; software, J.F.D.T.; validation, J.R.S. and K.D.S.Y.; formal analysis, J.R.S., A.L. and J.F.D.T.; investigation, J.R.S., J.F.D.T. and K.B.A.; resources, K.D.S.Y.; data curation, K.D.S.Y.; writing—original draft preparation, J.R.S. and C.A.S. writing—review and editing, C.A.S., R.R.T. and K.B.A.; visualization, J.F.D.T.; investigation, K.D.S.Y.; supervision, J.R.S. and K.D.S.Y.; project administration, J.R.S.; funding acquisition, J.R.S. and R.R.T. All authors have read and agreed to the published version of the manuscript.

**Funding:** This research was funded by the National Science Foundation (NSF) grant number 1832635.

**Acknowledgments:** We acknowledge the support from the National Science Foundation (Award #1832635), Fulbright US Scholar Program, and Philippine-American Educational Foundation (PAEF).

**Conflicts of Interest:** The authors declare no conflict of interest.

## Notes

- <sup>1</sup> COVID-19, or coronavirus disease 2019, a contagious disease caused by a virus, the severe acute respiratory syndrome coronavirus 2 (SARS-CoV-2).
- <sup>2</sup> In the field of epidemiology, the basic reproduction number ( $R_0$ ) is a parameter used to describe the expected number of people that can be infected by a sick individual. It is used extensively in the mathematical formulations for the “Susceptible Infected Removed” (SIR) model and extensions (Anderson and May 1992).
- <sup>3</sup> For reference, USD 1 is equivalent to approximately PhP 50 in year 2020.
- <sup>4</sup> It should be noted that for the 2018 IO, the Operating Surplus is not included. The Operating Surplus is removed from the IO matrices.
- <sup>5</sup> In the grouping of the industries in the Philippine IO, wholesale and retail trade is combined with repair of motor vehicles and motorcycles.

## References

- Albala-Bertrand, Jose M. 1993. *The Political Economy of Large Natural Disasters: With Special Reference to Developing Countries*. Oxford: Clarendon Press.
- Ali, Jalal, and Joost R. Santos. 2015. Modeling the ripple effects of IT-based incidents on interdependent economic systems. *Systems Engineering* 18: 146–61. [CrossRef]
- Anderson, Roy M., and Robert May. 1992. *Infectious Diseases of Humans: Dynamics and Control*. Oxford: Oxford University Press.
- Anderson, Roy M., Hans Heesterbeek, Don Klinkenberg, and T. Déirdre Hollingsworth. 2020. How will country-based mitigation measures influence the course of the COVID-19 epidemic? *The Lancet* 394: 931–34. [CrossRef]
- Aviso, Kathleen B., Divina Amalin, Michael Angelo B. Promentilla, Joost R. Santos, Krista Danielle S. Yu, and Raymond R. Tan. 2015. Risk assessment of the economic impacts of climate change on the implementation of mandatory biodiesel blending programs: A fuzzy inoperability input–output modeling (IIM) approach. *Biomass and Bioenergy* 83: 436–47. [CrossRef]
- Bick, Alexander, Adam Blandin, and Karel Mertens. 2020. Work from Home after the COVID-19 Outbreak. Available online: <https://www.dallasfed.org/-/media/documents/research/papers/2020/wp2017r1.pdf> (accessed on 26 July 2022).
- Centers for Disease Control and Prevention. 2007. Interim Pre-Pandemic Planning Guidance: Community Strategy for Pandemic Influenza Mitigation in the United States: Early, Targeted, Layered Use of Nonpharmaceutical Interventions. Available online: <https://stacks.cdc.gov/view/cdc/11425> (accessed on 24 July 2022).
- Centers for Disease Control and Prevention. 2017. Community Mitigation Guidelines to Prevent Pandemic Influenza—United States, 2017. Available online: <https://stacks.cdc.gov/view/cdc/45220> (accessed on 24 July 2022).
- Centers for Disease Control and Prevention. 2018. Past Pandemics. Available online: <https://www.cdc.gov/flu/pandemic-resources/basics/past-pandemics.html> (accessed on 24 July 2022).

- Chen, Jiangzhuo, Anil Vullikanti, Joost Santos, Srinivasan Venkatramanan, Stefan Hoops, Henning Mortveit, Bryan Lewis, Wen You, Stephen Eubank, Madhav Marathe, and et al. 2021. Epidemiological and economic impact of COVID-19 in the US. *Scientific Reports* 11: 20451. [CrossRef] [PubMed]
- Dietzenbacher, Erik. 2006. Multiplier estimates: To bias or not to bias? *Journal of Regional Science* 46: 773–86. [CrossRef]
- Dingel, Jonathan, and Brent Neiman. 2020. How many jobs can be done at home? *Journal of Public Economics* 189: 104235. [CrossRef]
- Eichenbaum, Martin S., Sergio Rebelo, and Mathias Trabandt. 2021. The Macroeconomics of Epidemics. *The Review of Financial Studies* 34: 5159–87. [CrossRef]
- El Haimar, Amine, and Joost R. Santos. 2015. A stochastic recovery model of influenza pandemic effects on interdependent workforce systems. *Natural Hazards* 77: 987–1011. [CrossRef]
- European Foundation for the Improvement of Living and Working Conditions. 2020. *Living, Working and COVID-19*. Luxembourg: Publications Office of the European Union.
- Ferguson, Neil M., Derek A. T. Cummings, Christopher Fraser, James C. Cajka, Philip C. Cooley, and Donald S. Burke. 2006. Strategies for Mitigating an Influenza Pandemic. *Nature* 442: 448–52. [CrossRef]
- Ferguson, Neil M., Daniel Laydon, Gemma Nedjati-Gilani, Natsuko Imai, Kylie Ainslie, Marc Baguelin, Sangeeta Bhatia, Adhiratha Boonyasiri, Zulma Cucunubá, Gina Cuomo-Dannenburg, and et al. 2020. Impact of Non-Pharmaceutical Interventions (NPIs) to Reduce COVID-19 Mortality and Healthcare Demand. Available online: <https://www.imperial.ac.uk/media/imperial-college/medicine/sph/ide/gida-fellowships/Imperial-College-COVID19-NPI-modelling-16-03-2020.pdf> (accessed on 24 July 2022).
- Foong, Steve Z. Y., Viknesh Andiappan, Kathleen B. Aviso, Nishanth G. Chemmangattuvalappil, Raymond R. Tan, Krista Danielle S. Yu, and Denny K. S. Ng. 2022. A criticality index for prioritizing economic sectors for post-crisis recovery in oleo-chemical industry. *Journal of the Taiwan Institute of Chemical Engineers* 130: 103957. [CrossRef]
- Gaduada, Ammielou, Christopher Ed Caboverde, and John Paul Flaminiano. 2022. Telework potential in the Philippines. *The Economic and Labour Relations Review* 33: 434–54. [CrossRef]
- Generalao, Ian Nicole. 2021. Measuring the telework potential of jobs: Evidence from the international standard classification of occupations. *The Philippine Review of Economics* 58: 92–127. [CrossRef]
- Gerking, Shelby D. 1976. *Estimation of Stochastic Input–Output Models: Some Statistical Problems*. New York: Springer New York.
- Ginsberg, Jeremy, Matthew H. Mohebbi, Rajan S. Patel, Lynnette Brammer, Mark S. Smolinski, and Larry Brilliant. 2009. Detecting influenza epidemics using search engine query data. *Nature* 457: 1012–14. [CrossRef]
- Haimes, Yacov Y., and Pu Jiang. 2001. Leontief-based model of risk in complex interconnected infrastructures. *Journal of Infrastructure Systems* 7: 1–12. [CrossRef]
- Haimes, Yacov Y., Barry M. Horowitz, James H. Lambert, Joost R. Santos, Chenyang Lian, and Kenneth G. Crowther. 2005a. Inoperability input-output model for interdependent infrastructure sectors. I: Theory and methodology. *Journal of Infrastructure Systems* 11: 67–79. [CrossRef]
- Haimes, Yacov Y., Barry M. Horowitz, James H. Lambert, Joost R. Santos, Kenneth G. Crowther, and Chenyang Lian. 2005b. Inoperability input-output model for interdependent infrastructure sectors. II: Case studies. *Journal of Infrastructure Systems* 11: 80–92. [CrossRef]
- Haleem, Abid, Mohd Javaid, and Raju Vaishya. 2020. Effects of COVID-19 pandemic in daily life. *Current Medicine Research and Practice* 10: 78–79. [CrossRef]
- Harris, Charles R., Jarrod Millman, Stefan J. van der Walt, Ralf Gommers, Pauli Virtanen, David Cournapeau, Eric Wieser, Julian Taylor, Sebastian Berg, Nathaniel J. Smith, and et al. 2020. Array programming with NumPy. *Nature* 585: 357–62. [CrossRef]
- Huzar, Timothy. 2020. COVID-19 Suppression Only Viable Strategy at the Current Time. Available online: <https://www.medicalnewstoday.com/articles/covid-19-suppression-only-viable-strategy-at-the-current-time#COVID-19> (accessed on 24 July 2022).
- ILO (International Labour Organization). 2020. COVID-19 Labour Market Impact in the Philippines: Assessment and National Policy Responses. Available online: [https://www.ilo.org/wcmsp5/groups/public/---asia/---ro-bangkok/---ilo-manila/documents/publication/wcms\\_762209.pdf](https://www.ilo.org/wcmsp5/groups/public/---asia/---ro-bangkok/---ilo-manila/documents/publication/wcms_762209.pdf) (accessed on 24 July 2022).
- James, Alex, Shaun C. Hendy, Michael J. Plan, and Nicholas Steyn. 2020. Suppression and Mitigation Strategies for Control of COVID-19 in New Zealand. Available online: <https://cpb-ap-se2.wpmucdn.com/blogs.auckland.ac.nz/dist/d/75/files/2017/01/Suppression-and-Mitigation-Strategies-New-Zealand-TPM-1.pdf> (accessed on 24 July 2022).
- Jansen, Pieter S. M. Kop. 1994. Analysis of multipliers in stochastic input-output models. *Regional Science and Urban Economics* 24: 55–74. [CrossRef]
- Kaplan, Stanley, and B. John Garrick. 1981. On the quantitative definition of risk. *Risk Analysis* 1: 11–27. [CrossRef]
- Leontief, W. 1936. Quantitative input and output relations in the economic system of the United States. *Review of Economics and Statistics* 18: 105–25. [CrossRef]
- MacKenzie, Cameron A., Joost R. Santos, and Kash Barker. 2012. Measuring changes in international production from a disruption: Case study of the Japanese earthquake and tsunami. *International Journal of Production Economics* 138: 293–302. [CrossRef]
- Messenger, Jon C. 2019. Conclusions and recommendations for policy and practice. In *Telework in the 21st Century*. Edited by Jon C. Messenger. Cheltenham: Edward Elgar Publishing, pp. 286–16.
- Miller, Ronald E., and Peter D. Blair. 2009. *Input-Output Analysis: Foundations and Extensions*, 2nd ed. Cambridge: Cambridge University Press.

- National Statistical Coordination Board. 2006a. *Input-Output Accounts of the Philippines, 2000*; Makati City: National Statistical Coordination Board. Available online: [https://psa.gov.ph/sites/default/files/IO2000\\_Publication\\_0.pdf](https://psa.gov.ph/sites/default/files/IO2000_Publication_0.pdf) (accessed on 30 June 2022).
- National Statistical Coordination Board. 2006b. *Input-Output Accounts of the Philippines, 2014*; Makati City: National Statistical Coordination Board. Available online: [https://psa.gov.ph/sites/default/files/NSCB%202006\\_IO%20%281%29\\_0.pdf](https://psa.gov.ph/sites/default/files/NSCB%202006_IO%20%281%29_0.pdf) (accessed on 30 June 2022).
- OECD. 2020. Productivity Gains from Teleworking in the Post COVID-19 Era: How Can Public Policies Make It Happen? Tackling Coronavirus (COVID-19): Contributing to a Global Effort. Available online: [https://read.oecd-ilibrary.org/view/?ref=135\\_135250-u15liwps4jd&title=Productivity-gains-from-teleworking-in-the-post-COVID-19-era](https://read.oecd-ilibrary.org/view/?ref=135_135250-u15liwps4jd&title=Productivity-gains-from-teleworking-in-the-post-COVID-19-era) (accessed on 30 June 2022).
- Okuyama, Yasuhide, and Joost R. Santos. 2014. Disaster Impact and Input-Output Analysis. *Economic Systems Research* 26: 1–12. [CrossRef]
- Okuyama, Yasuhide, and Krista Danielle Yu. 2019. Return of the inoperability. *Economic Systems Research* 31: 467–80. [CrossRef]
- Orsi, Mark J., and Joost R. Santos. 2010. Probabilistic Modeling of workforce-based disruptions and input-output analysis of interdependent ripple effects. *Economic Systems Research* 22: 3–18. [CrossRef]
- Philippine Statistics Authority. 2017. PSA Releases the 65 × 65 2012 Input-Output Tables. Available online: <https://psa.gov.ph/statistics/input-output/node/128892> (accessed on 18 July 2022).
- Philippine Statistics Authority. 2018. Input-Output Accounts of the Philippines. Available online: <https://psa.gov.ph/sites/default/files/2018%20Input-Output%20Accounts%20Publication.pdf> (accessed on 18 July 2022).
- Pueyo, Tomas. 2020. Coronavirus: The Hammer and the Dance, What the Next 18 Months Can Look Like, If Leaders Buy Us Time. Available online: <https://medium.com/@tomaspueyo/coronavirus-the-hammer-and-the-dance-be9337092b56> (accessed on 24 July 2022).
- Rose, A. 2004. *Economic Principles, Issues, and Research Priorities in Hazard Loss Estimation*. Edited by Yasuhide Okuyama and Stephanie E. Chang. Modeling Spatial and Economic Impacts of Disasters. New York: Springer, pp. 13–36.
- Santos, Joost. 2006. Inoperability input-output modeling of disruptions to interdependent economic systems. *Systems Engineering* 9: 20–34. [CrossRef]
- Santos, Joost. 2020a. Reflections on the impact of “flatten the curve” on interdependent workforce sectors. *Environment Systems and Decisions* 40: 185–88. [CrossRef]
- Santos, Joost. 2020b. Using input-output analysis to model the impact of pandemic mitigation and suppression measures on the workforce. *Sustainable Production and Consumption* 23: 249–55. [CrossRef]
- Santos, Joost, and Yacov Y. Haimes. 2004. Modeling the demand reduction input-output inoperability due to terrorism of interconnected infrastructures. *Risk Analysis* 24: 1437–51. [CrossRef]
- Santos, Joost R., Larissa May, and Amine El Haimar. 2013. Risk-based input-output analysis of influenza epidemic consequences on interdependent workforce sectors. *Risk Analysis* 33: 1620–35. [CrossRef]
- Santos, Joost R., Lucia Castro Herrera, Krista Danielle S. Yu, Sheree Ann T. Pagsuyoin, and Raymond R. Tan. 2014a. State of the art in risk analysis of workforce criticality influencing disaster preparedness for interdependent systems. *Risk Analysis* 34: 1056–69. [CrossRef] [PubMed]
- Santos, Joost R., Sheree T. Pagsuyoin, Lucia C. Herrera, Raymond R. Tan, and Krista Danielle Yu. 2014b. Analysis of drought risk management strategies using dynamic inoperability input–output modeling and event tree analysis. *Environment Systems and Decisions* 34: 492–506. [CrossRef]
- Taubenberger, Jeffrey K., and David M. Morens. 2006. 1918 Influenza: The mother of all pandemics. *Emerging Infectious Diseases* 12: 15–22. [CrossRef]
- Ten Raa, Thijs, and Jose Manuel Rueda-Cantuche. 2007. Stochastic analysis of input–output multipliers on the basis of use and make tables. *Review of Income and Wealth* 53: 318–34.
- US Department of Labor. 2020. Guidance on Preparing Workplaces for COVID-19. Available online: <https://www.osha.gov/Publications/OSHA3990.pdf> (accessed on 25 May 2020).
- WHO (World Health Organization). 2007. WHO Activities in Avian Influenza and Pandemic Influenza Preparedness (January–December 2006). Available online: [https://apps.who.int/iris/bitstream/handle/10665/70696/WHO\\_CDS\\_EPR\\_GIP\\_2007.3\\_eng.pdf?sequence=1](https://apps.who.int/iris/bitstream/handle/10665/70696/WHO_CDS_EPR_GIP_2007.3_eng.pdf?sequence=1) (accessed on 25 July 2022).
- WHO (World Health Organization). 2020. Impact of COVID-19 on People’s Livelihoods, Their Health and Our Food Systems. Available online: [https://www.who.int/news/item/13-10-2020-impact-of-covid-19-on-people%20%281%29\\_0.pdf](https://www.who.int/news/item/13-10-2020-impact-of-covid-19-on-people%20%281%29_0.pdf) (accessed on 11 July 2022).
- Yu, Derrick Ethelbhart C., Krista Danielle S. Yu, and Raymond R. Tan. 2020a. Implications of the pandemic-induced electronic equipment demand surge on essential technology metals. *Cleaner and Responsible Consumption* 1: 100005. [CrossRef]
- Yu, Krista Danielle S., and Kathleen B. Aviso. 2020. Modelling the Economic Impact and Ripple Effects of Disease Outbreak. *Process Integration and Optimization for Sustainability* 4: 183–86. [CrossRef]
- Yu, Krista Danielle S., Kathleen B. Aviso, Joost R. Santos, and Raymond R. Tan. 2020b. The Economic Impact of Lockdowns: A Persistent Inoperability Input-Output Approach. *Economics* 8: 109. [CrossRef]

## Article

# Impact of the COVID-19 Pandemic on the Business Environment in Slovakia

Lucia Svabova <sup>1,\*</sup>, Katarina Kramarova <sup>1</sup> and Dominika Chabadova <sup>2</sup>

<sup>1</sup> Department of Economics, Faculty of Operation and Economics of Transport and Communications, University of Zilina, 01026 Zilina, Slovakia

<sup>2</sup> Graduate, Faculty of Operation and Economics of Transport and Communications, University of Zilina, 01026 Zilina, Slovakia

\* Correspondence: lucia.svabova@uniza.sk

**Abstract:** The COVID-19 pandemic has significantly affected economic development in countries around the world. It has deepened existing problems and increased the need for economic transformation, modernisation, and qualitative development, and launched new technological reforms that have led to the emergence of new economic forms of business models, consumption, as well as policies at the level of the state or local governments. The impacts of the pandemic are still visible in many aspects of life, including economic activity and the individual decisions of economic subjects at the level of households, enterprises, and governments. In this article, we present the results of the impact analysis of the COVID-19 pandemic with an emphasis mainly on the SMEs segment focusing on the tourist, hotel, and gastro industry (generally as one of the most affected by the pandemic). We also analyse the impact of the pandemic on the automotive industry because it is the most important manufacturing industry in Slovakia. Regardless of which industries of the national economy they are operating in, SMEs are assumed to be a driving force of structural changes, increasing employment, and economic growth. SMEs in Slovakia represent approx. 99% of all active enterprises and significantly participate in the success of the national economy. They are also an important factor in cooperation with large enterprises; in the case of Slovakia, the automotive industry should be highlighted (it is an important part of the secondary sector). The analysis and evaluation of the impacts of the COVID-19 pandemic are carried out as a temporal and comparative analysis of the selected economic and industrial indicators relevant to the assessment of the impact of the pandemic on the Slovak business environment. It is an overview study of development; the impact of the pandemic is expressed mostly through the ratio indicators. The basis for time analysis and comparison is data representing the economic status quo before the pandemic (2019), and the ordinary period is represented by data distinctive of the pandemic period (2020, 2021). The results of the analysis indicate that the pandemic had a strong impact on employment and the sales of enterprises operating in the accommodation and catering industries; on the other hand, it did not reflect in the number of defunct enterprises, which points to the potential effectiveness of anti-pandemic measures in terms of state aid for the business sector. The results of this study may serve as a basis for the evaluation of introduced support programs (the evaluation of optimal combination and the impact of fiscal policies during a national/global economic crisis between assisting households, companies, state, and local governments) immediately mitigating the consequences of anti-pandemic measures, but also programs to eliminate the long-term consequences of the pandemic in the business environment in Slovakia. Assessing the situation is also a prerequisite for evaluating the impact of current crises (problems such as the global failure of logistics chains due to the pandemic, inflation, the environmental and energy crisis, and migration due to war conflict and applied sanction measures). In general, it is possible to claim that the pandemic was a huge burden for Slovakia; on the other hand, it was a lesson learned.

**Keywords:** COVID-19 pandemic; business environment; pandemic impact

**Citation:** Svabova, Lucia, Katarina Kramarova, and Dominika Chabadova. 2022. Impact of the COVID-19 Pandemic on the Business Environment in Slovakia. *Economics* 10: 244. <https://doi.org/10.3390/economics10100244>

Academic Editor: Robert Czudaj

Received: 13 August 2022

Accepted: 26 September 2022

Published: 7 October 2022

**Publisher's Note:** MDPI stays neutral with regard to jurisdictional claims in published maps and institutional affiliations.



**Copyright:** © 2022 by the authors. Licensee MDPI, Basel, Switzerland. This article is an open access article distributed under the terms and conditions of the Creative Commons Attribution (CC BY) license (<https://creativecommons.org/licenses/by/4.0/>).

## 1. Introduction

Small and medium enterprises (SMEs) play a key role in the economic acceleration of any country. Their contribution (from the national economic perspective) is based mainly on their considerable number, adaptability, flexibility in decision making, and resulting synergistic effect. Even if a small enterprise alone does not show a huge benefit to the economy, given that there are many small enterprises, their overall benefit, the synergistic effect, is quite substantial and increases significantly (Carvalho and Costa 2014; Gregova and Novikov 2017; Haviernikova and Mynarzova 2018, etc.). For the Slovak economy (like other centrally planned Eastern Bloc economies), their creation was irreplaceable for the process of transforming a centrally planned economy into a market one after 1989.

The growth and development of SMEs depend mostly on a favourable business environment determined by both micro and macro facts (Civelek et al. 2016; Meyer and Meyer 2016), since the business environment has a significant impact on the progress, competitiveness, and opportunities for business growth (Khan et al. 2021; Kolkova 2020). Following this, SMEs are the most important catalysts of economic growth (Henderson and Weiler 2010). In Slovakia, according to the data provided by the Slovak Business Agency (2022), SMEs represent more than 99% of all active business entities in a long-term period, including all three years under analysis (2019–2021). For example, for 2021, SMEs provided job opportunities in the corporate economy to almost 3/4 of the active workforce (74%) and participated in more than half of the added value creation (55%).

The business of SMEs worldwide was recently affected, mainly by the COVID-19 pandemic. The effects of the pandemic manifested primarily in the economic, social, health, and technological areas at the national and global level and affected the behaviour and decision making of all economic entities in the meaning of their general classification—households, enterprises, state. The pandemic is seen as a systemic shock with profound implications, both in the short- and medium- to long-term (Engidaw 2022). Many enterprises were pushed to the brink of collapse due to anti-pandemic measures, and national economies suffered significantly in almost all aspects (Song and Zhou 2020). The pandemic is still affecting behaviour and decision making in some areas to varying degrees. Although it is assumed that the global threat from the COVID-19 pandemic has passed (the severity of the disease is gradually reaching the level of “common” flu), the consequences of the pandemic on the activity and economy of selected entities still persist, e.g., the functionality of global supply chains has not yet been ensured (the situation that occurred during the pandemic is currently escalated by the war conflict and the adopted sanction measures).

During the COVID-19 pandemic, which officially began in Slovakia in March 2020, the adopted anti-pandemic (epidemiological) measures were able to flatten the epidemiological curve; however, they contributed to a sudden and sharp economic decline, unemployment, and an increase in public spending. The COVID-19 pandemic has significantly affected major economic variables such as economic growth, world trade, public spending, unemployment and underemployment, foreign direct investment, production and sales, household consumption, the investment of enterprises, etc. (Khan et al. 2021). The depression in the business environment during the pandemic period was mainly caused by government regulations, the stoppage of production, a decrease in demand, or by changes in consumer preferences (Kramarova et al. 2022; Martin and Roman 2021; Ugurlu and Jindrichovska 2022). It had a negative impact on the economies of all countries, notwithstanding the strictness of the measures they adopted. This can be explained by the fact that the current economies are interconnected; therefore, developments in their external environment significantly affect the given country (Caplanova 2021). In general, the strictness, length, and nature of the COVID-19 anti-pandemic measures around the world were (and still are) relatively heterogeneous.

The national anti-pandemic measures and regulations had different impacts on businesses, as sectors are not homogeneous (Phan et al. 2015), and therefore, responded differently to market shocks due to the pandemic. The relationship between supply and demand during the pandemic (considering the market for goods and services as well as

the market for capital and labour) varied depending on the characteristics of the industry (depending on the market, the business acted on the supply side or on the demand side) (Belas et al. 2021).

In Slovakia, the anti-pandemic measures were mainly aimed at reducing the mobility of people and preventing social contact. As a result of the enforcement of curfews and voluntary social distancing, enterprises mainly operating in tourism, travel, dining, and leisure were critically affected. The closing of borders and the suspension of air transport were felt most by the service sector, restaurants, bars, theatres, cinemas, swimming pools, ski resorts, and tourism in general. Closures of cities and industries, travel restrictions, and border closures by other countries led to large declines in service sectors such as retail, tourism, and hospitality. The COVID-19 pandemic also drastically reduced hotel occupancy rates. In terms of the size of enterprises, it was mainly a limitation of the activities of SMEs. Wu et al. (2022) found that a decrease in production due to the COVID-19 crisis in European enterprises depended on capacity utilisation and the size of employment.

As for Slovakia, according to the Slovak Business Agency (2022), up to 94% of SMEs experienced a drop in sales during the first and second waves of the pandemic. If we wish to point out the problems of large enterprises due to the crisis in Slovakia, the automotive industry in Slovakia was affected significantly, especially during the first wave of the pandemic. The automotive industry is generally a typical representative of the globalised sectors and, together with other representative sectors, is still struggling to meet demand due to the COVID-19 crisis. All four car producers operating in Slovakia (Volkswagen, Peugeot, Kia, Jaguar Land Rover) shut down production in March 2020, which subsequently caused most car suppliers in Slovakia to significantly reduce production volume or close operations due to the lack of car components. Breaks in production due to a lack of components are still present today.

In the case of the automotive industry, there is also the high dependence of the whole world on China, the largest automotive market in the world and, at the same time, the largest producer of components. The impact of the pandemic restrictions in China—such as production suspension—was, therefore, also significant for global automakers (the anti-pandemic measures adopted in China are considered the strictest), as most of them have joint ventures in China and remain exposed to the risk of disrupted supply chains.

The next significantly affected sector was the electronic industry, to which the same could be applied—the closure of Chinese assembly companies caused a freeze in orders for the producers of semiconductors and other electronic components that are needed in modern consumer electronics devices.

On the other hand, the response of enterprises and governments to the challenges associated with the COVID-19 pandemic has led to the development of the digital economy around the world. In addition to enterprises that were bankrupted because of the adopted measures, many took advantage of the opportunities in the given situation and adapted or differentiated their business activities. During the pandemic, state effort was necessary to help enterprises overcome the adopted anti-pandemic measures.

In this article, we focus on the automotive industry due to its significant importance to the Slovak economy (the Slovak industry is clearly automobile-oriented), as well as the tourism–hotel industry, and restaurant services, as some of the areas most affected by the COVID-19 pandemic due to adopted anti-pandemic measures. The results of the analysis provide scope for understanding the impact of the unexpected fact on the activity and economy of the mentioned sectors, as well as the Slovak economy. It also offers the possibility of carrying out further research studies which, based on the results of this analysis, can subsequently contribute to an objective assessment of the state aid provided to economic entities because of the COVID-19 crisis in Slovakia.

The contribution itself is an overview analytical study consisting of three main parts—a literature overview that maps the COVID-19 crisis from the perspective of the functionality of business entities (including SMEs); the methodology and data selection, where we present the methodology of analysis, including the data we worked with; and the results



and discussion section, where we present our findings and discuss them in close connection with their usefulness for other studies.

## 2. Literature Review

In recent decades, the attention of academics and policymakers towards the entrepreneurship of SMEs has increased (Acs et al. 2008; Audretsch and Keilbach 2007). This interest has been stimulated by various studies showing the significant contribution of SMEs to economic growth, job creation, and innovation (Carree et al. 2007; Storey 2016). According to the study of the World Bank (2022), SMEs account for most businesses globally and are important contributors to job creation and global economic development. From a quantitative perspective, SMEs represent about 90% of businesses and more than 50% of employment worldwide. It is estimated that their contribution to the GDP in emerging countries is up to 40%.

A prerequisite for the development of SMEs is a stable and quality level of the business environment (Haviernikova and Mynarzova 2018). The quality of the business environment plays an important role in the national economic sector—in the economic system of any country (Olah et al. 2019; Dvorsky et al. 2018) and different economic and non-economic indicators related to it. An adequate business environment with regulatory procedures that are transparent, easy to comply with, and accessible to all despite their connections may foster a greater contribution of the sector of SMEs to the growth of the national economy (Rocha 2012). In connection with the COVID-19 pandemic, e.g., studies presented by Belas et al. (2021), OECD (2020), Vaskovic and Siranova (2022), Versic et al. (2022) etc., indicate that, even with different types of state aid (e.g., temporary social-economic measures protecting companies and their employees affected by national lockdowns, such as provisional and exceptional indemnities; deferring the payment of contributions payable by employers in the statutory social security scheme; “kurzarbeit” schemes; financial compensation due to a decrease in sales, etc.), the pandemic (in terms of the adopted anti-pandemic measures) had a negative impact on the quality of the business environment. However, the impact of the pandemic in individual countries may also differ based on the different level of social experience of any country, which will already have been exposed to epidemics and other catastrophic events in the past (Belas et al. 2015; Gavurova et al. 2020).

Regarding the economic and other impacts of the COVID-19 pandemic on the national economies and the global economy, many studies evaluate these impacts using different statistical and non-statistical assessing methods/models. Their common denominator is, for instance, the fact that they see the duration of the pandemic as an unexpected fact and place its effects (mainly economic ones) in a mutual confrontation, primarily with the effects of the global financial crisis, which began to take shape in 2008, e.g., Almeida et al. (2021), de Crescenzo and Lepers (2021), Gehrke and Weber (2020), Gunay (2020), Gunay and Can (2022), Li et al. (2022), Wilkins et al. (2021), etc. In connection with the pandemic, another significant part of the studies is represented by the evaluation of support systems and schemes in individual countries, which were aimed at supporting (financially, socially) the most affected entities, e.g., Brulhart et al. (2020), Burdenko et al. (2021), Dell’Ariccia et al. (2022), Juergensen et al. (2020), Roziqin et al. (2021), Xia et al. (2021), Zamani et al. (2022), etc. In connection with this, other studies focus on evaluating the impact of the COVID-19 crisis and the impact of provided financing support systems and schemes from the perspective of the burden on public and government budgets. OECD (2021) states that the COVID-19 pandemic caused a significant deterioration in public finances, adding to pre-existing strains from long-term structural challenges, including population ageing, climate change, rising inequality, digitalisation, and automation. As for Slovakia, the preparation of the budget for 2021 already also included expenses intended for dealing with the pandemic (state aid to the business sector and households, financing the costs of testing and vaccinating the population). However, the expenses in the final sum exceeded the planned value by 1.9% of the GDP for 2021 (Council for Budget Responsibility SR 2022). Next, the empirical studies and analysis of empirical data also demonstrate various im-

pacts of the crisis on individual economic sectors. Valaskova et al. (2021) investigated changes in the shopping behaviour of consumers in Slovakia during the pandemic and identified the most important factors impacting consumers' financial situations, as well as the effects on the maintenance of new shopping habits established during the pandemic period. The studies show that uncertainty related to the COVID-19 pandemic had a heterogeneous effect on the performance of individual enterprises, industries, and financial markets in general. Some industries benefited from the COVID-19 crisis, while others were negatively affected, considering different assessment variables (Abbas et al. 2021; Anayi et al. 2021; Das 2022; Juergensen et al. 2020; Klein and Smith 2021; Kramarova et al. 2022; Szczygielski et al. 2022b; Szczygielski et al. 2022a, etc.). Among the areas most affected by the COVID-19 pandemic are offline areas focused on personal communication: tourism, transportation, accommodation and food provision, healthcare, and entertainment (Abbas et al. 2021; Li et al. 2021; Kramarova et al. 2022), all in connection with the issue of the SMEs, e.g., Belas et al. (2021) compared SMEs in Czechia and Slovakia and investigated the impact of the pandemic on various areas of business management and different economic segments where the SMEs under analysis operated. The conclusions confirm that the pandemic had a negative impact on the financial performance of SMEs, while this burden was not homogeneous in terms of the industry orientation of the examined enterprises. Disproportionality was also noted regarding the sectoral classification of SMEs and its effects on unemployment and the creation of new job positions (Kramarova et al. 2022). Juergensen et al. (2020), in response to the first wave of the pandemic, argue that in the short run, most SMEs mainly faced logistical challenges in addition to demand disruptions, although the severity differed across enterprises and industries.

### 3. Materials and Methods

The analysis and evaluation of the impacts of the COVID-19 pandemic were carried out as a temporal and comparative analysis of selected economic and industrial indicators (aggregates) relevant (and generally accepted) to the assessment of the pandemic impact on the Slovak enterprises, hence, mainly SMEs, since they represent 99.9% of all active enterprises in Slovakia. They participate considerably in the creation of the Slovak GDP and employment as the basic economic macro-aggregates.

The indicators are clustered into general indicators (number of SMEs, number of established and defunct SMEs, number of allowed SMEs restructurings) and economic/financial indicators (gross production, added value, rate of employment, sales, amount of funds drawn for SMEs, amount of funds drawn for SMEs to support jobs).

The contribution is an overview study of development; the impact of the pandemic is expressed through the ratio indicators. The basis for time analysis and comparison is data representing the economic and social status quo before the pandemic (2019), and the ordinary period is represented by data distinctive of the pandemic (2020, 2021). All the data we work with are secondary quantitative data originating mostly from the reports presented by the Slovak Business Agency and official statistics from the Slovak Statistical Office. These are not aggregated data; data aggregation and summarisation were necessary for the analysis. The length of the time series, or the period the data covers, always depends on its availability; therefore, this period might differ for the selected indicators (we mainly focus on the pandemic period—years 2020 and 2021 if it is available). However, the previous period mainly serves to estimate the development trend of the indicators.

We firstly pay attention to the analysis of the overall situation in the Slovak economy and the business environment. After that, we deal with a more detailed analysis of the selected sectors according to the official classification of economic activities (SK NACE classification), namely with the automotive industry as the most important industry in Slovakia (the Slovak economy is oriented toward the automotive industry; in Slovakia, there operate four car producers). The share of the automotive industry in the total industrial production of Slovakia reached 49.5%, and the share of exports was 46.6% for 2019. In 2019, this industry directly employed more than 177,000 people and directly and indirectly

generated up to 275,000 jobs. The designation according to the SK NACE classification is as follows:

- Automotive industry: manufacturing (NACE C), thereof, the manufacture of vehicles:
  - NACE C29—Manufacture of motor vehicles, trailers, and semi-trailers;
  - NACE C30—Manufacture of other transport equipment.

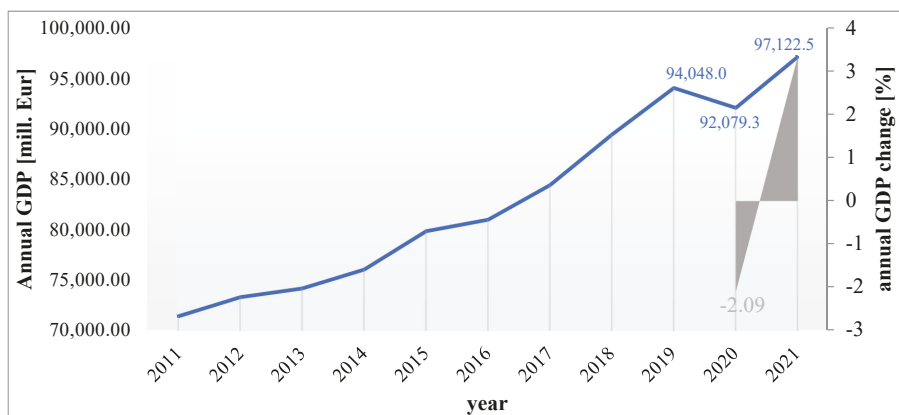
The second sector we examine is the sector of services (tertiary economic sector) related to the tourism–hotel industry, and restaurant services, as some of the areas most affected by the COVID-19 pandemic and the anti-pandemic measures adopted. The designation according to the SK NACE classification is as follows:

- Restaurants, catering establishments, hotels, and guesthouses: accommodation and food service activities (NACE I) thereof:
  - NACE I55—Accommodation;
  - NACE I56—Food and beverage service activities.

#### 4. Results and Discussion

##### 4.1. Analysis of the Impact of the COVID-19 Pandemic on the Business Environment in Slovakia

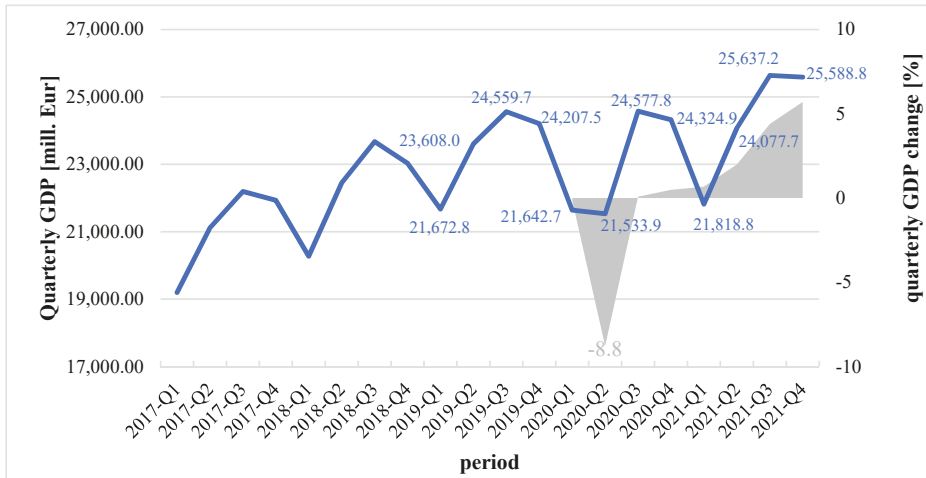
The development of the Slovak GDP (the most used measure of the size of the national economy in general; in this case, expressed in constant prices calculated by chaining volumes to the reference year 2015), as it can be seen in Figure 1, dramatically dropped mainly in 2020 (in comparison to the pre-pandemic year 2019), which corresponds with the first and second wave of the COVID-19 pandemic in Slovakia when the government adopted the strictest anti-pandemic measures during the whole duration of the pandemic and its presence in Slovakia. While before the spread of the pandemic the medium-term forecast of the National Bank of Slovakia spoke of a 2.2% growth of the national economy for 2020 (National Bank of Slovakia 2019), the GDP was by more than six perceptual points lower compared to 2019. According to the Statistical Office of the Slovak Republic (2021), the drop in the GDP was caused by declines in the key industries, especially in the automotive industry, and by declines in several parts of the service sector.



**Figure 1.** Annual GDP development in Slovakia. Source: own elaboration based on the data from the Statistical Office of the Slovak Republic.

In 2021, the development of the Slovak GDP recovered and reached a higher value than before the pandemic outbreak. Therefore, it can be concluded that the impact of the pandemic on the Slovak GDP was not as fatal as it seemed. Instead, it mainly had an impact on slowing down the economic development of the Slovak economy. On the other hand, however, it is necessary to point out that the GDP was primarily formed thanks to the growing consumption of households.

A more detailed overview of the quarterly GDP development is presented in Figure 2. The blue line represents the GDP development, and the grey area shows the percentage change in the pandemic period for the corresponding quarter compared to the pre-pandemic year 2019.



**Figure 2.** Quarterly GDP development of the Slovak Republic. Source: own elaboration based on the data from Statistical office SR.

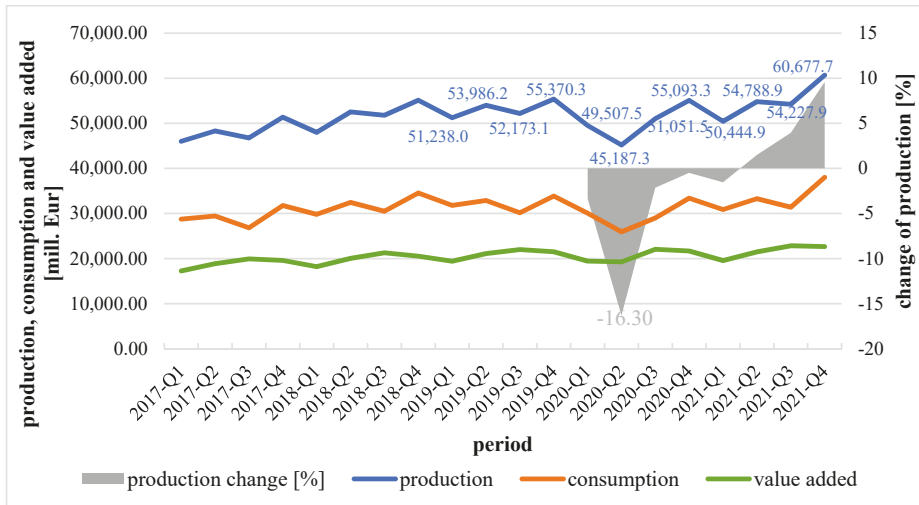
The quarterly GDP development had a seasonal character. It is visible, among other things, that the pandemic had the greatest impact on the Slovak GDP in the second quarter of 2020 (GDP = EUR 21.5B), which corresponds, for example, with the state in the second quarter of 2017. On the other hand, in the third quarter of both pandemic years the GDP increased—in the third quarter of 2020 by 11.4% compared to the second quarter of 2020, and by 1.5% in the case of a year-on-year comparison (to the third quarter of 2019) and the third quarter of 2021, by 4.4% in the case of a year-on-year comparison to the pre-pandemic period (to the third quarter of 2019). For instance, compared to the state during the global financial crisis of 2008, the difference in GDP changes was also that, after a significant decrease in the first and second quarters, the increase in the third quarter was jumpy, which was related to the specific shock that caused it. We assume that this significant difference was mainly caused by the relaxation of anti-pandemic measures at the end of May 2020 and 2021. The waves of the COVID-19 disease had a seasonal character; in the late spring and summer of 2020 and 2021 the situation improved, and strict anti-pandemic measures were not required.

Comparing the quarter data on the Slovak GDP during the pandemic, the pandemic had a milder impact on its development in 2021 than in 2020, as the fluctuations were not as significant as during 2020. In the third and fourth quarters of 2021, the GDP reached the values seen before the pandemic. The reason for this was primarily the health measures adopted (the mass vaccination of the population), which did not require such a strict closure of economic activities as in 2020. Further, effective aid from the state focused primarily on supporting the employment of enterprises threatened by the crisis, as well as the loss of sales due to the restriction of their business activities in response to the anti-pandemic measures adopted in Slovakia. The state aid was provided within the support scheme “First Aid”, and the structure of this support varied depending on the character of the recipients and the severity of the impact of anti-pandemic measures on their business activities. The aid contributions consisted of a contribution from the state budget of the Slovak Republic, or a contribution from the state budget of the Slovak Republic and, at the same time, a

contribution from the European Social Fund (in a ratio of 85:15 and 50:50, respectively, depending on the territorial region of the aid recipient).

In reality (based on the quick estimate compiled according to the ESA methodology), the GDP of Slovakia in the second quarter of 2022 increased year-on-year by 1.7% (Statistical Office of the Slovak Republic 2022a); however, the situation still lags behind the pre-pandemic estimates.

Closely related indicators to the GDP are production, intermediate consumption, and added value (other macro-aggregates expressed in constant prices). Their development is shown in Figure 3.

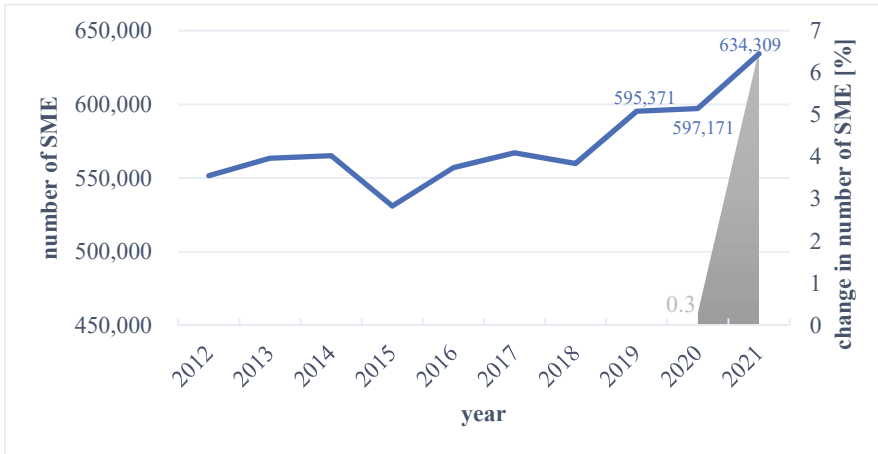


**Figure 3.** Development of production, intermediate consumption, and value added. Source: own elaboration based on the data from the Statistical Office of the Slovak Republic.

In Figure 3, in addition to seasonal fluctuations, we can see that before the pandemic, the development of all three indicators had a slightly increasing trend. In the second quarter of 2020, the value of production fell by more than 16%, a drop of EUR 8.8B compared to the same period of 2019. The decrease was mainly caused by intermediate consumption, which decreased in that period due to the lower consumption of services and less production. At that time, the first anti-pandemic measures were adopted, and a state of emergency was introduced. In addition to the suspension of air traffic, industrial production was also limited, which was reflected in this significant drop. In the same quarter, intermediate consumption decreased by more than 21% compared to 2019, representing a loss of almost EUR 7B. However, this decrease was followed by an increase in the next quarter due to more relaxed anti-pandemic measures and the re-opening of production and operations, as well as due to the provision of support schemes “First Aid” from the state. However, these are still lower values than in the base year 2019. The change acquired positive values only from the second quarter of 2021. When compared to the base year 2019, it increased by 1.5%. Then, the situation in the country improved, measures were eased, testing was expanded, and vaccination began. This helped to restore the activity of enterprises and their consumption.

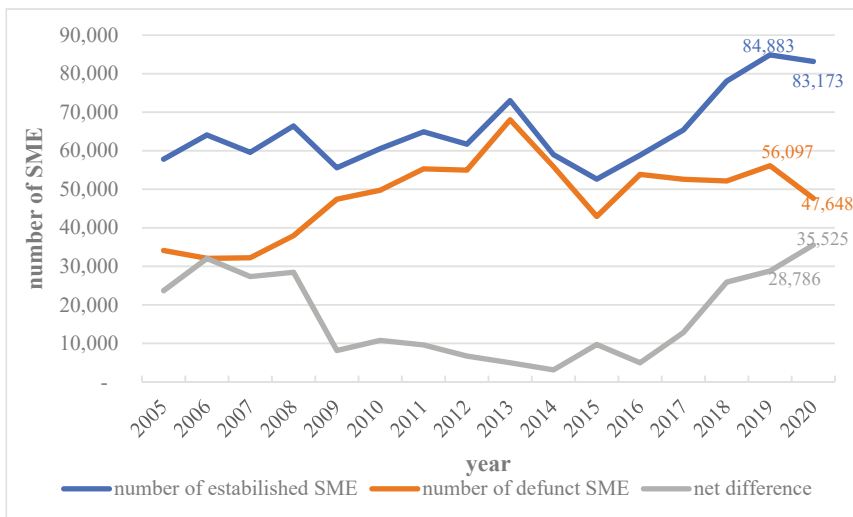
To examine the impact of the COVID-19 pandemic on the Slovak economy and business environment, we also used the number of active business entities operating in Slovakia, one of the indicators of the general nature. This indicator generally points to the business activity and interest in doing business in Slovakia. Figure 4 namely shows the development of the number of SMEs in Slovakia (blue line) and its changes during the pandemic

compared to 2019 (a grey area). The focus on SMEs is purposeful, since from the beginning of the statistics on the number and size of enterprises in Slovakia, SMEs (including micro-enterprises) comprise 99.9% of all enterprises actively operating in the country.



**Figure 4.** Development of the number of SMEs. Source: own elaboration based on the data from the Slovak Business Agency.

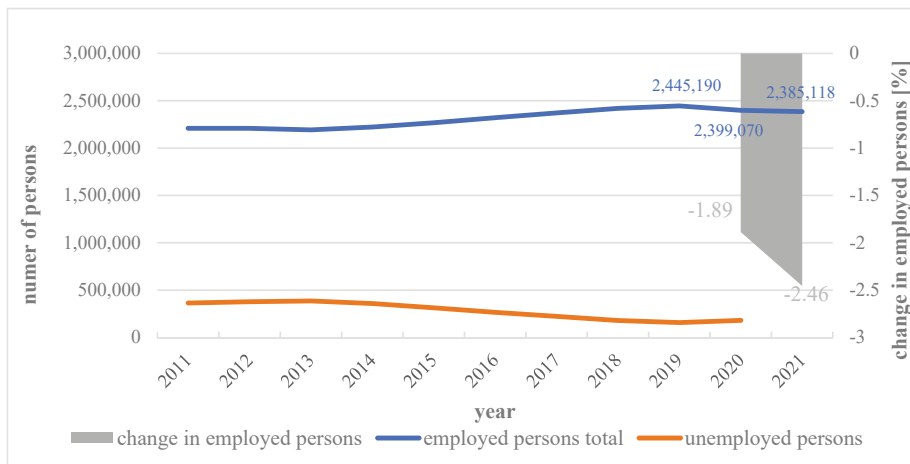
The total number of enterprises has been increasing since 2018, even after the pandemic outbreak. However, the reason for this cannot be found in the growing number of newly established enterprises, but in the decreasing number of enterprises that ceased their business activities. By comparing both indicators, the net increase is another general indicator that characterises the business environment in Slovakia, focusing on the segment of SMEs (regardless of the economic sector they operate in). The development of these indicators is presented in Figure 5.



**Figure 5.** Development of the number of established and defunct SMEs and their net difference. Source: own elaboration based on the data from the Slovak Business Agency.

In 2020 the number of newly established enterprises decreased year-on-year by 2%, which indicates that the business environment, which in that year was influenced by anti-pandemic measures, was evaluated by potential starting entrepreneurs as rather unfavourable for starting a business. On the other hand, the number of defunct entrepreneurs also decreased, namely by 15.1%, which may indicate that, despite the worsening business conditions due to the anti-pandemic measures adopted, the financial support from the state was so effective that it limited the number of enterprises that would otherwise terminate their activity. Most of them represented self-employed entrepreneurs. Therefore, the change in the total net increase in 2020 is positive; it increased by 23.4%.

We also assessed the state of the business environment in the country through the analysis of employment, which reflects the state of the labour market in Slovakia. As for employment, overcoming the economic and social crisis caused by the pandemic and raising real wages and the standard of living of citizens is important. In this regard, the Government of the Slovak Republic is committed to promoting measures aimed at maintaining employment, creating new jobs, and improving the quality of the business environment in Slovakia by reducing bureaucracy in employment, administrative complexity, and tax burden. The development of the number of employed (blue line) and unemployed persons (orange line) and the percentage change of employed compared to the base year (a grey area) are shown in Figure 6.



**Figure 6.** Number of employed and unemployed persons. Source: own elaboration based on the data from the Statistical Office of the Slovak Republic.

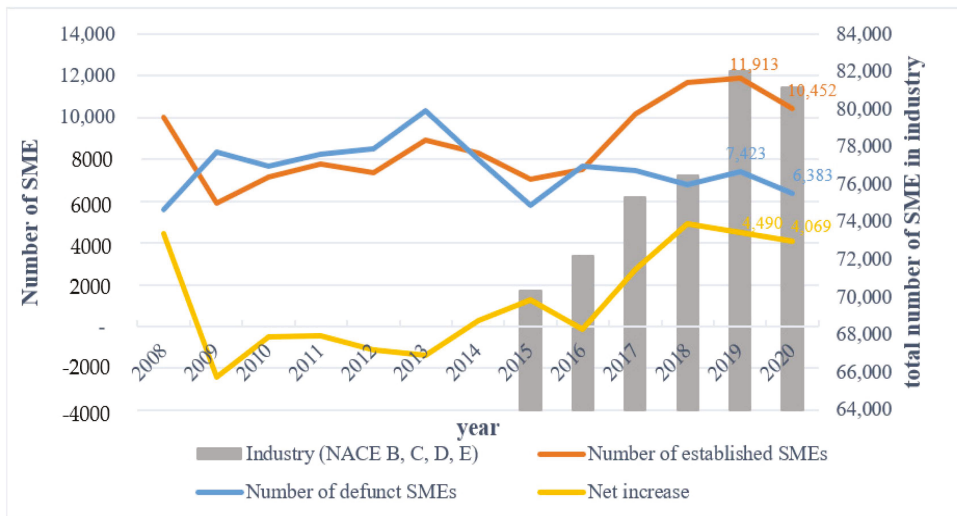
Based on the data from the Slovak Statistical Office, overall, the number of employed persons had an increasing trend (the state from 2013 to 2019). On the contrary, the number of people actively looking for work was continuously decreasing. In 2019, in the case of both indicators, the Slovak economy reported the best values ever (considering the whole existence of the Slovak Republic since 1993)—the registered unemployment rate was only 4.92%. Subsequently, in 2020 and 2021, the registered unemployment rate increased by 2.65 per cent in 2020 compared to 2019, and 1.84 per cent in 2021 compared to 2019. In absolute terms, the number of employed persons in 2020 reduced close to the level of 2017 (1.9% less than employment in 2019), and in 2021 the situation was even worse (decreased by 2.5% in comparison to 2019). Therefore, it is obvious that the pandemic negatively affected the labour market situation (a result of reduced production, closed establishments, reduced mobility, or the impossibility of working from home). The increase in unemployment and the decrease in employment occurred even though the number of active enterprises in the Slovak economy increased during the pandemic years. The

structural analysis of the unemployed indicates that layoffs occurred mainly among so-called agency employees and employees who had reduced working hours. Likewise, the number of persons unemployed before reaching retirement age increased.

4.2. Analysis of the Impact of the Pandemic on the Business Environment in the Selected Sectors

4.2.1. Industry (Secondary Sector)

According to the [Statistical Office of the Slovak Republic \(2022b\)](#), the industry includes activities related to mining and quarrying; manufacturing, the supply of electricity, gas, steam and cold air, and the supply of water; the cleaning and drainage of waste water, and waste and waste removal services. Figure 7 shows the number of SMEs in the industry sector from 2015 to 2020. The data are for all enterprises with a main industrial activity, including self-employed persons.



**Figure 7.** Development of the total number of active SMEs, newly established SMEs, defunct SMEs, and the net increase in SMEs in the industry. Source: own elaboration based on the data from the Statistical Office of the Slovak Republic.

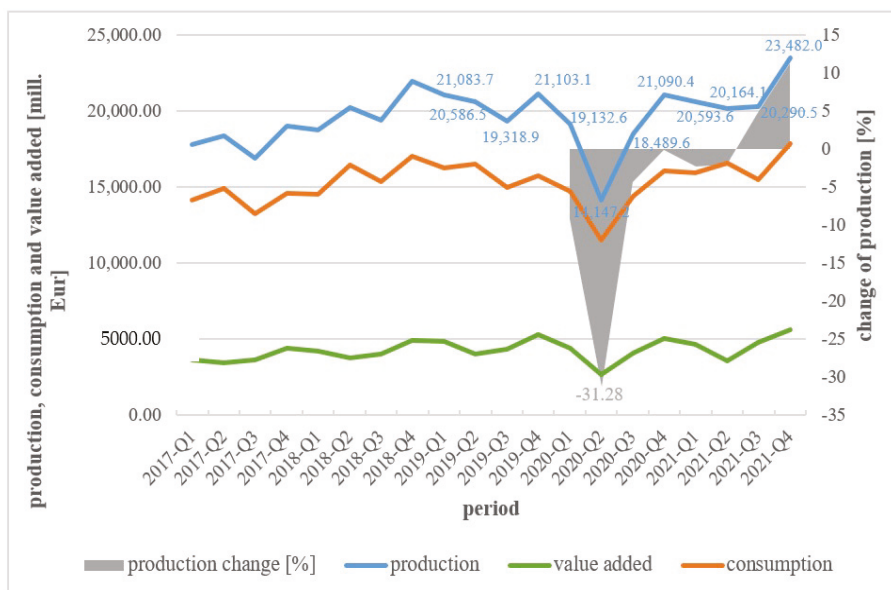
The development of the number of SMEs in the industry sector (grey bar graph) demonstrated a growing trend in the monitored period with a maximum in 2019, when the number of SMEs reached over 82,030 enterprises. However, the pandemic visibly disrupted this development trend, since the number of SMEs fell to approx. eighty-one thousand in 2020.

In addition to the total number, we can also monitor the development of the number of established and defunct SMEs in the industry, as well as their net increase. The data indicate that the number of newly established SMEs in the industry (orange line) fluctuated during this period. After the financial crisis in 2008–2009, the number of newly established SMEs increased slightly; the highest value in this general indicator was revealed in 2019 when 11,913 SMEs were established, representing 14.5% of the total number of active SMEs. In 2020, the value of the indicator decreased by 12.9% to 10,452 (absolute difference of 1461 entities), which is a 12.9% share in the total number of active SMEs operated in the industry sector in Slovakia (a decrease of 2.2 percentage points). The number of defunct SMEs (blue line) in the pandemic year 2020 also decreased compared to 2019 by 14% (by 1040 entities in absolute terms). From the perspective of the quality of the business environment, however, it is acceptable that the total number of newly established



SMEs exceeded the number of defunct ones, which is mirrored in a positive value of the net increase.

Figure 8 shows depicted data, except for other data on gross production reported for the industrial production (NACE C). According to the [Statistical Office of the Slovak Republic \(2021\)](#), this quantitative economic aggregate expresses the value of own products and services which are the result of the economic activity of business entities in the monitored period (in our case, in constant prices). As follows from its time series analysis, the impact of the pandemic is mainly seen in the second quarter of 2020, when the production fell year-on-year by 31.28%, which is a drop of almost EUR 6.5B. At the same time, the decrease is already visible in the first quarter of 2020, when the value of the production fell by more than 9% compared to the same period of 2019 (by approx. EUR 1.95B). Until the third quarter of 2021, the output of industrial production was lower than in the reference period of 2019. However, after this period, the indicator recovered and reached values exceeding the pre-pandemic values (approx. EUR 23.5B in constant prices).

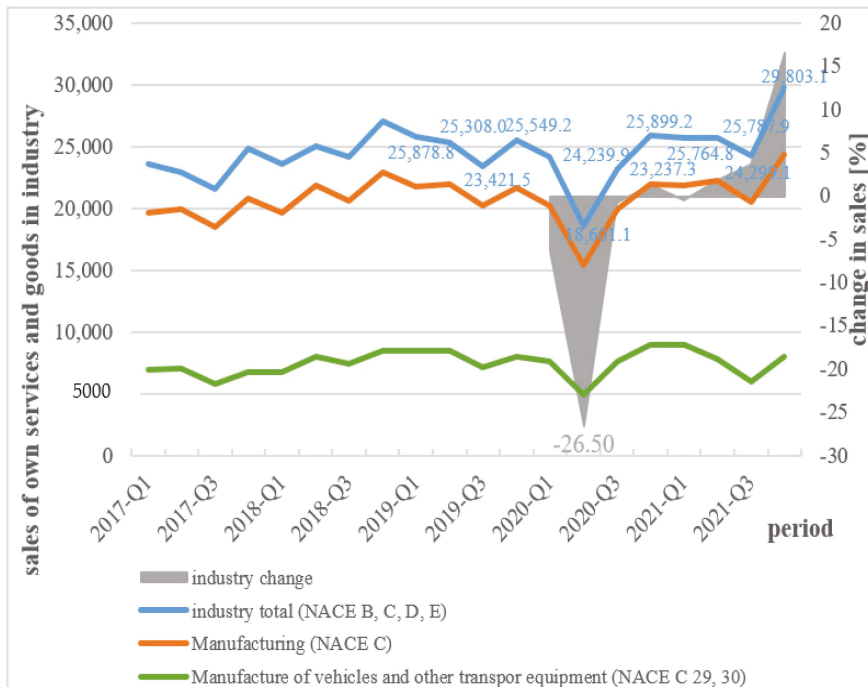


**Figure 8.** Development of gross production, gross value added and intermediate consumption in NACE C: Manufacturing. Source: own elaboration based on the data from Statistical Office SR.

Following the structural analysis of this economic aggregate, the decrease in its values was mainly caused by reducing the intermediate consumption (the estimated impact of the change in the consumption on the change in the aggregate indicator of the gross production is approx. 61.4%; *ceteris paribus* condition was applied), which, due to the suspension of production in Slovakia during the first wave of the pandemic, fell by almost 30.5% to approx. EUR 11.5B in the second quarter of 2020 compared to the same quarter of 2019. In general, its development copied the development of gross production—the recovery phase mainly started in the fourth quarter of 2021 when the values exceeded the pre-pandemic values. According to another economic indicator, the value added, the pre-pandemic state was also reached in the fourth quarter of 2021 when the indicator reached EUR 5.6B. This is based on the year-on-year comparison with the pre-pandemic state of 2019, an increase of 5.1%. Overall, the worst situation was in the second quarter of 2020, as in the case of the previous indicators when the value added of the Slovak industry was only EUR 2.65B. The negative change in the development of this indicator (based on a year-on-year comparison

of the second quarter of 2020 and 2019) affected the value of the production indicator (and thereby its decrease) by 38% (ceteris paribus condition was applied).

The impact of the pandemic on sales in the industry is depicted in Figure 9. According to the [Statistical Office of the Slovak Republic \(2022a\)](#), sales for own services and goods include the value of sales from the sale of own products, services, trade goods, revenues from orders, and revenues from the sale of real estate, realised in the monitored period and intended for domestic and foreign customers.

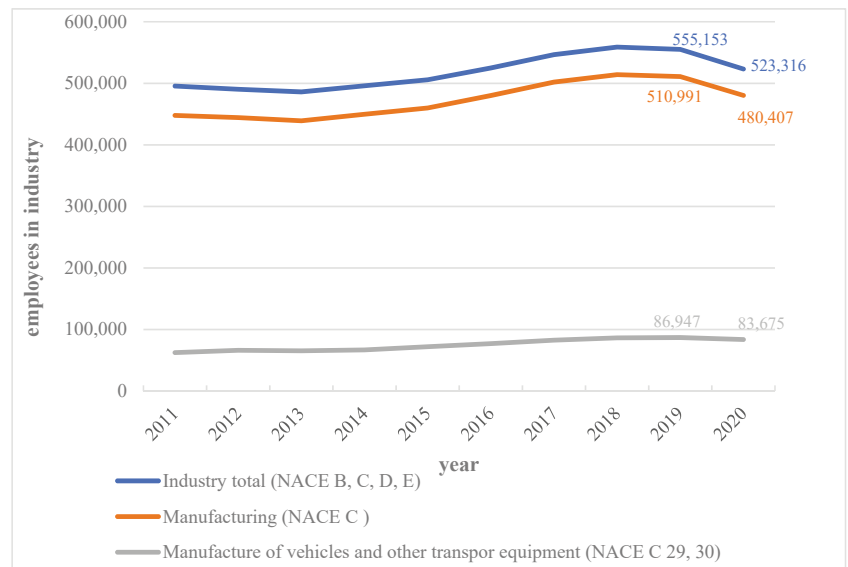


**Figure 9.** Development of sales of own services and goods in the industry. Source: own elaboration based on the data from the Statistical Office of the Slovak Republic.

The development of sales in the monitored period fluctuated slightly. The largest decrease in sales in the industry sector occurred in the second quarter of 2020 when it fell by 26.5% to EUR 18.6B, compared to the same quarter of 2019. However, as in the case of previous economic indicators, an obvious recovery occurred in the fourth quarter of 2021—the reported sales were 16.6% higher (in constant prices). Therefore, although the results indicate that the pandemic was mainly reflected in sales for 2020, the values of the indicator for 2021 lag behind the pre-pandemic values of 2019 by 11.1%.

The largest share in the sales of industrial production covers the production of means of transport (SK NACE C—29, 30; in 2019—33.7%, in 2020—37.8%, in 2021—29.3%). In the first wave of the pandemic, which took place in the second quarter of 2020 in Slovakia, the production of vehicles by some car companies was limited or stopped, which caused this high drop in sales. In fact, sales for own services and goods in the vehicle manufacturing sector had already fallen by 9.6% in the first quarter of 2020, but the most significant drop occurred in the second quarter of 2020, when they fell by more than 41% year-on-year, which represented a loss compared to 2019 in the amount of EUR 3.5B. In the next period, sales increased, which was helped by the relaxation of anti-pandemic measures and the start of car production towards the end of 2020. However, an obvious recovery occurred again in the fourth quarter of 2021.

Figure 10 presents the data that are distinctive of the employment in the industry sector and its selected subsectors. According to the [Statistical Office of the Slovak Republic \(2022b\)](#), the average number of employed persons includes, in addition to the average number of employees, self-employed persons.



**Figure 10.** Development of employment in the industry. Source: own elaboration based on the data from the Statistical Office of the Slovak Republic.

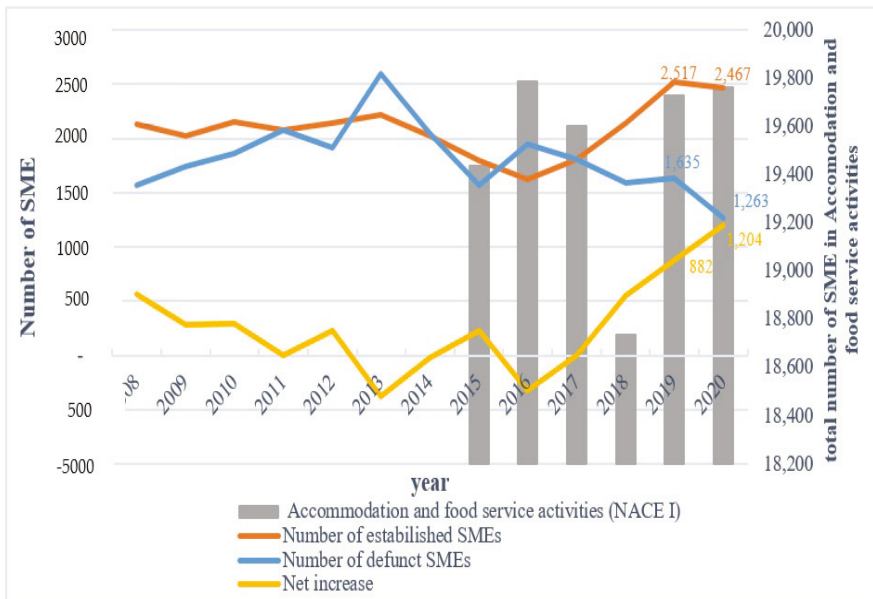
The number of employees in the industry and the sector of the manufacture of vehicles and other transport equipment (SK NACE C 29, 30) also had a growing character before the pandemic until 2019. In 2020, the number of persons employed in the industry decreased by 5.7% (in absolute terms by 31,837 people) due to layoffs caused by the COVID-19 pandemic and adopted anti-pandemic measures. In the case of a closer look at the enterprises operating in the sector of the manufacture of vehicles and other transport equipment, the results indicate that the employment in these industry subsectors had a 15.7% share in the employment for the whole industry in 2019, and 16% in 2020, respectively. Year-on-year, the employment in these subsectors decreased by 3272 people, i.e., 3.4%. The given subsectors participated in the overall decrease in employment in the industry sector by 10.7% (ceteris paribus condition was applied), and most dismissed employees had the character of agency workers.

#### 4.2.2. Sectoral Analysis of Services (Tertiary Sector)

The tertiary sector represents the service sector, which includes several subsectors/categories. In connection with the COVID-19 pandemic and its impacts, our attention is paid mainly to the analysis of enterprises operating in catering services (restaurants, hospitality) and accommodation services (hotels, tourism). According to the [Slovak Business Agency \(2022\)](#), 99.9% of the companies operating there are categorised as SMEs. The subsectors of these services are generally considered the most at risk due to the pandemic and adopted anti-pandemic measures.

Figure 11 graphically shows the development of the number of business entities operating in the accommodation and food service sectors. Obviously, there was a growing trend in the number of established SMEs in Slovakia until 2019. Compared to this trend, however, in the pandemic year 2020, the number of newly established companies decreased

by approx. 2%. The number of defunct SMEs also decreased, and the net increase was positive and growing over the last few years, which continued even in 2020. Thus, the impact of the pandemic on the number of SMEs is only visible in the case of the number of newly established companies.



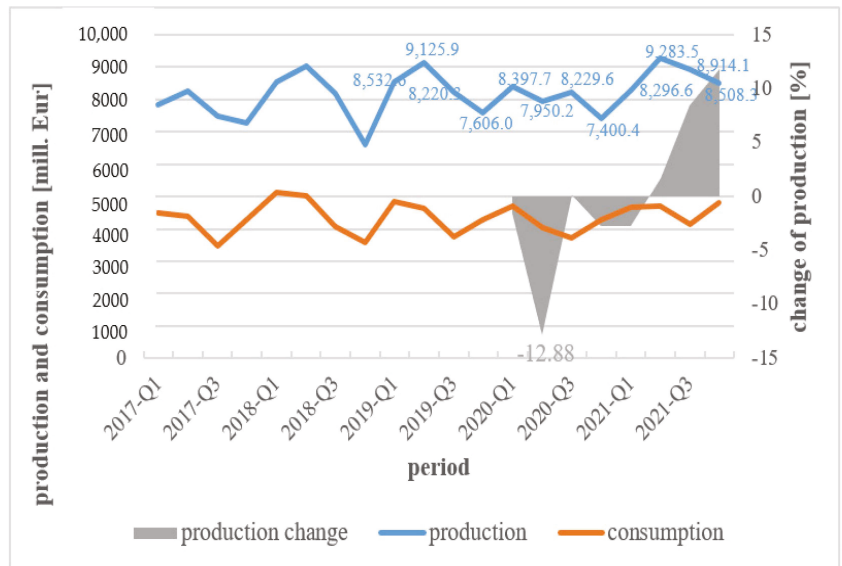
**Figure 11.** Development of total number, established, defunct number and a net increase in SME in NACE I: Accommodation and food service activities. Source: own elaboration based on the data from the Statistical Office of the Slovak Republic.

The impact of the pandemic on the gross production (in constant prices) of this NACE category was most pronounced in the second quarter of 2020, when production fell by almost 13% compared to 2019, representing a loss of EUR 1.2B. The situation is described in Figure 12. The situation with gross production improved in the third quarter of 2020; the value of the indicator was slightly above the pre-crisis values in the same period of 2019. From the second quarter of 2021, production began to grow gradually, but with the arrival of the next waves of the COVID-19 pandemic and the adopted anti-pandemic measures, the production of enterprises operating in the accommodation and food services decreased again.

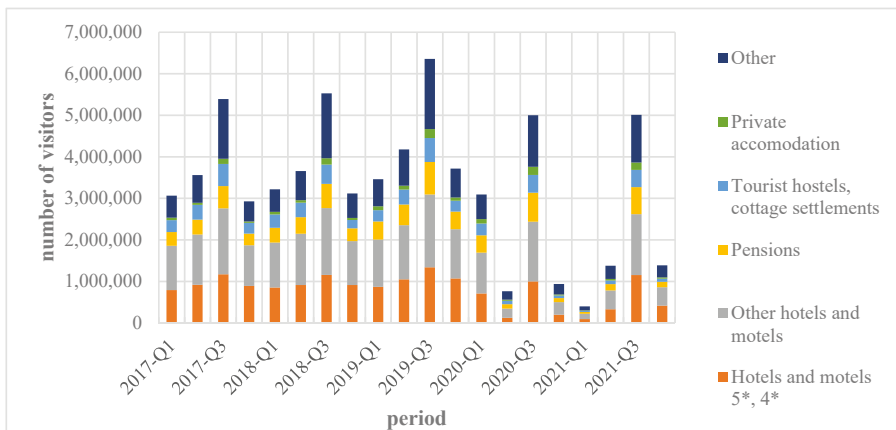
The tourism industry is also characterised by the number of visitors in accommodation facilities, and appropriate data are presented in Figure 13.

In the second quarter of 2020, when the mobility of people was most significantly restricted in Slovakia, the number of visitors in accommodation facilities decreased sharply year-on-year to only 15% of the number in 2019. Since the beginning of the pandemic, the number of visitors decreased significantly throughout the year, most significantly in the fourth quarter of 2020 and the first quarter of 2021, when a state of emergency was declared and no operations, especially ski resorts, could operate. Nevertheless, a partial recovery approaching the state before the pandemic indicates estimates for 2022.

If we monitor the number of overnight stays of visitors in accommodation services, we can say that compared to 2019, the number of overnight stays was lower in both years. However, the most significant reduction occurred in the first quarter of 2021. Compared to 2019, the number of overnight stays was only 11.4%, a drop of almost 89%.



**Figure 12.** Development of the gross production and intermediate consumption in NACE I: Accommodation and food service activities. Source: own elaboration based on the data from the Statistical Office of the Slovak Republic.



**Figure 13.** Development of the number of visitors in accommodation facilities. Source: own elaboration based on the data from Slovak Business Agency.

Figure 14 presents the sales of companies operating in accommodation and food service activities. The sales gradually decreased since 2020; the lowest sales were recorded in the second quarter of 2020. At the same time, it follows from the data analysis that the revival and, thus, the increase in sales always occurred in response to the relaxation of the anti-pandemic measures adopted at that time in Slovakia. As for most European countries, the situation in Slovakia worsened primarily in the autumn and winter months.

Accommodation sales fell by almost EUR 105M compared to 2019, which is a drop of almost 85%. Restaurant sales fell by almost EUR 146M, which is a decrease of almost 47% compared to 2019. At the time, a state of emergency and curfew were in place, so many

companies were forced to close. During the pandemic, sales developed depending on the situation and the adopted anti-pandemic measures and their strictness.

A more detailed look at the structure of tourism sales shows that in 2020 the tourism industry recorded the lowest sales during the last ten years. The biggest impact on tourism sales was for passive tourism sales, which reached only 11.5% of sales in 2019, i.e., they fell by 88.5% (by EUR 620M in absolute terms). The tourists paid almost 90% less for these services (air tickets, hotels, reservations, restaurants, etc.) than in the same period of 2019.

As for the employment in this sector, overall employment as well as the number of employees fluctuated throughout the monitored period. This is partly due to seasonality, but until the end of 2019 it demonstrated a growing trend. However, the employment saw a downward trend since the pandemic outbreak. The development is shown in Figure 15. Due to data availability, we show total employment in the service sector as employment in NACE G, H, and I. Unfortunately, data for the earlier period were not available.

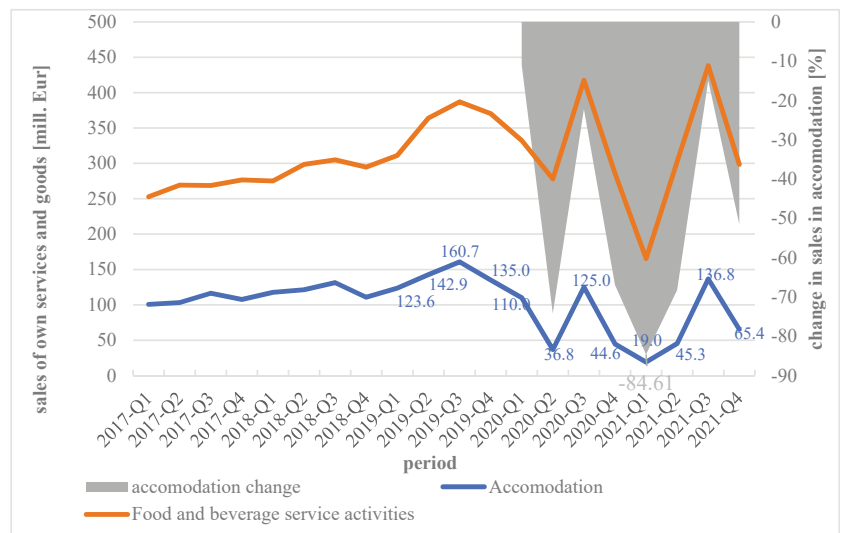


Figure 14. Development of sales of own services and goods in accommodation and food and beverage service activities. Source: own elaboration based on the data from Statistical Office SR.

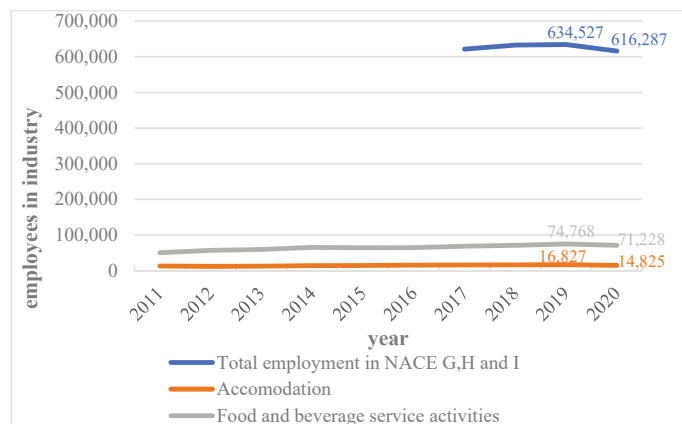


Figure 15. Development of employment in accommodation and food and beverage service activities. Source: own elaboration based on the data from the Statistical Office of the Slovak Republic.

A more detailed look at the number of employees in the service sector during the COVID-19 pandemic shows that employment was lower in both years than in 2019. However, the largest decrease was in the first quarter of 2020 when the number of employees fell by more than 25,000 compared to the same quarter of 2019.

Employment in accommodation services before the pandemic had a 2.7% share in overall employment in the services according to SK NACE classification G, H, I, and in food and beverage service activities this was 14% (all for 2019). In 2020, the number of employees in this sector decreased by almost 12%, which represented 2000 persons who lost their jobs in accommodation services. In the restaurant and food service activities sector, the decrease in employees after the pandemic outbreak was more moderate, but more employees lost their jobs in absolute numbers. Compared to 2019, the number of employees decreased by 3.5%, representing over 3500 people.

#### 4.3. Discussion

The COVID-19 pandemic caused a significant drop in the Slovak GDP due to closed operations, problems with the disruption of supply chains, or restrictions on the mobility of people. While before the spread of the pandemic, the medium-term forecast of the National Bank of Slovakia spoke of a 2.2% growth of the Slovak economy for 2020 (National Bank of Slovakia 2019), the GDP growth was negative (−) 4.4%. A partial recovery of the Slovak economy occurred in 2021 when the GDP recorded an increase of approx. 3%. In the case of Slovakia, the development of the Slovak GDP was like the development of GDP in other EU countries when the economic slump was recorded, especially in the first year of the immediate response to the COVID-19 pandemic. Likewise, there was a negative development in the indicator of the registered number of unemployed persons in Slovakia, and its development was like the development of the Slovak GDP, i.e., a partial recovery occurred in 2021 when the unemployment rate was 6.76%, i.e., by 0.81 percentage higher than in 2020; however, this was by 1.84 lower behind the pre-pandemic year 2019. The impact of the pandemic can be seen mainly in the areas heavily affected by the anti-pandemic restrictions and especially in such job positions where working from home was impossible. We consider the increase in unemployment and the decrease in sales as basic indicators of the possible effects of COVID-19 on selected sectors of the economy. In that case, the sector of services, especially the hotel industry and restaurant services (SK NACE I), belong among the most hit. These industries, or the tourism industry, were declared the riskiest even globally.

Tourism in Slovakia, from the perspective of participation in the value of GDP (the share of the direct GDP of tourism in the GDP of the Slovak economy is long-term at the level of approx. 2.8%), is not so important, but indirectly its share is higher, and it is gaining importance (indirect approx. 6%). Almost 100% of these enterprises simultaneously fall into the segment of SMEs.

The state of tourism significantly worsened just due to the closure of borders, the suspension of air traffic, the ban on passing between districts, and the closure of wellness centres, hotels, swimming pools, and ski resorts. The pandemic and measures to prevent the spread of the coronavirus weakened this part of the service sector most noticeably. A more detailed look at the structure of tourism sales shows that in 2020 the tourism industry in Slovakia recorded the lowest sales during the last ten years, and the biggest impact of the pandemic on tourism sales was in the case of passive tourism sales, which reached only 11.5% in 2019. Due to the forced limitation of their business activities, a decrease in consumer demand and an increase in costs, restaurants, hospitality establishments, and accommodation establishments were exposed to the pressure of reducing costs, for example, by laying off their employees. In terms of this kind of service, the adequacy of the aid provided by the state was constantly debated during the COVID-19 crisis, as enterprises of this type of service represent a significant part of the enterprises that decided to close their operations due to the pandemic. They also point to the threat to their activity in the current era as a direct result of the energy crisis and high inflation, which are both the result

of the gradual recovery of the economy after the end of the most difficult periods of the COVID-19 pandemic, but also of the war conflict. To support tourism in Slovakia, it would also be possible to increase the value of so-called recreational vouchers. These vouchers serve to cover part of the costs of recreation in Slovakia for employees of large companies. If the employees' annual limit allocated for stays in Slovakia increased, tourism would be supported, and thus, the situation in this industry could improve. Here, however, it would be necessary not to transfer the burden for this increase in the limit of recreation vouchers to employers, but the participation of the state would also be necessary.

The study was also focused on the most important industrial sector in Slovakia—the automotive industry (SK NACE C—29, 30). At the same time, this is an industry that is characterised by the close cooperation of large automobile companies and SMEs operating in the given industry with related activities specific to the production of automobiles in the conditions of Slovakia. The COVID-19 crisis limited or stopped the production of vehicles, which caused the car producers a large drop in sales. In fact, sales for own services and goods in the vehicle manufacturing sector had already fallen by 9.6% in the first quarter of 2020, but the most significant drop occurred in the second quarter of 2020, when they fell by more than 41% year-on-year, which represented a loss compared to 2019 in the amount of EUR 3.5B. In the next period, sales in this industry increased; however, an obvious recovery occurred again in the fourth quarter of 2021. The decline in sales in the given industry was not only recorded because of the interruption of production due to the introduction of measures against the spread of the virus in Slovakia, but also due to the introduction of restrictions abroad, which disrupted the logistic chains ensuring the supply of the necessary components, which “fully” manifested the integration of the Slovak economy into the global economy.

## 5. Conclusions

In this study, we focused on the quantification of the impact of the COVID-19 pandemic on the economy of Slovakia. For this purpose, we used public data from the Slovak Statistical Office and Slovak Business Agency. These data are published yearly in separate studies. First, it was necessary to collect all the values of indicators in order to characterise the SME environment in Slovakia. In the analysis, we focused on the general environment in the country. Consequently, we analysed two selected sectors—tourism, including food and accommodation services, one of the most affected sectors by the pandemic, and the automobile industry, one of the most important economic sectors in the Slovak economy. The analysis showed the fields in which the economy as a whole and individual sectors were most affected by the pandemic, or rather, adopted anti-pandemic measures.

The contribution of this article can, therefore, be the identification and quantification of those aspects of the business environment in Slovakia that were affected by the pandemic. This can help to focus the right measures, serving to mitigate the immediate but also the long-term consequences of a pandemic or other emergency in the future.

As a weakness of this study, we consider the fact that some data were measured only on an annual basis. Quarterly or even monthly indicators would capture the development of the situation during the pandemic in more detail and with greater accuracy. In addition, it would also be possible to quantify the impacts more precisely. In this study, we used only a simple percentage change compared to the base pre-pandemic year 2019. In the continuation of this study, we would also like to focus on the statistical modelling of the time series development of the analysed indicators. These models could subsequently be used to predict their development in a situation without a pandemic. This would increase the precision when quantifying the pandemic's impact.

**Author Contributions:** Conceptualisation, L.S. and D.C.; methodology, L.S. and D.C.; software, L.S.; validation, L.S. and D.C.; formal analysis, L.S. and D.C.; investigation, L.S.; resources, D.C.; data curation, D.C.; writing—original draft preparation, L.S.; writing—review and editing, L.S. and K.K.; visualisation, L.S.; supervision, L.S.; project administration, L.S.; funding acquisition, L.S. All authors have read and agreed to the published version of the manuscript.



**Funding:** This publication was created thanks to support under the Operational Program Integrated Infrastructure for the project: Identification and possibilities of implementation of new technological measures in transport to achieve safe mobility during a pandemic caused by COVID-19 (ITMS code: 313011AUX5), co-financed by the European Regional Development Fund.

**Informed Consent Statement:** Not applicable.

**Data Availability Statement:** Publicly available datasets were analysed in this study.

**Conflicts of Interest:** The authors declare no conflict of interest. The funders had no role in the design of the study; in the collection, analyses, or interpretation of data; in the writing of the manuscript, or in the decision to publish the results.

## References

- Abbas, Jaffar, Riaqua Muebeen, Paul Terhembra Iorember, Saqlain Raza, and Gulnara Mamirkulova. 2021. Exploring the impact of COVID-19 on tourism: Transformational potential and implications for a sustainable recovery of the travel and leisure industry. *Current Research in Behavioral Sciences* 2: 100033. [CrossRef]
- Acs, Zoltan J., Sameeksha Desai, and Jolanda Hessels. 2008. Entrepreneurship, economic development and institutions. *Small Business Economics* 31: 219–34. [CrossRef]
- Almeida, Vanda, Salvador Barrios, Michael Christl, Silvia De Poli, Alberto Tumino, and Wouter van der Wielen. 2021. The impact of COVID-19 on households' income in the EU. *The Journal of Economic Inequality* 19: 413–31. [CrossRef] [PubMed]
- Anayi, Lena, Nick Bloom, Philip Bunn, Paul Mizen, Myrto Oikonomou, Pawel Smietanka, and Gregory Thwaites. 2021. Update: Which Firms and Industries Have Been Most Affected by COVID-19? Economics Observatory. Available online: <https://www.economicsobservatory.com/update-which-firms-and-industries-have-been-most-affected-by-covid-19> (accessed on 19 September 2022).
- Audretsch, David, and Max Keilbach. 2007. The Localisation of Entrepreneurship Capital: Evidence from Germany. *Papers in Regional Science* 86: 351–65. [CrossRef]
- Belas, Jaroslav, Valer Demjan, Jozef Habanik, Maria Hudakova, and Juraj Sipko. 2015. The business environment of small and medium-sized enterprises in selected regions of the Czech Republic and Slovakia. *E+M Ekonomie a Management* 18: 95–110. [CrossRef]
- Belas, Jaroslav, Beata Gavurova, Jan Dvorsky, Martin Cepel, and Pavol Durana. 2021. The impact of the COVID-19 pandemic on selected areas of a management system in SMEs. *Economic Research-Ekonomika Istraživanja* 35: 3754–77. [CrossRef]
- Brulhart, Marius, Rafael Lalive, Tobias Lehmann, and Michael Siegenthaler. 2020. COVID-19 financial support to small businesses in Switzerland: Evaluation and outlook. *Swiss Journal of Economics and Statistics* 156: 15. [CrossRef]
- Burdenko, Elena Viktorovna, Elena Vyacheslavovla Bykasova, and Svetlana Vladimirovna. 2021. State Support of Russian Small and Medium-Sized Business in the COVID-19 Pandemic and Development Prospects. In *Handbook of Research on Sustaining SMEs and Entrepreneurial Innovation in the Post-COVID-19 Era*. State-Support-of-Russian-Small-and-Medium-Sized-Business-in-the-COVID-19-Pandemic-and-Development-Prospects. Hershey: IGI Global, pp. 438–64. [CrossRef]
- Caplanova, Anetta. 2021. Economic impacts of COVID 19 pandemic: Country and global perspective. In *Rethinking Media and Socio-Cultural Change: India and the Globe in Times of Pandemic*. London: HP Hamilton Limited, pp. 3–18. Available online: [https://sekarl.euba.sk/ar1-eu/sk/detail-eu\\_un\\_cat-0278413-Economic-Impacts-of-COVID-19-Pandemic/](https://sekarl.euba.sk/ar1-eu/sk/detail-eu_un_cat-0278413-Economic-Impacts-of-COVID-19-Pandemic/) (accessed on 15 July 2022).
- Carree, Martin, Andre Van Stel, Roy Thurik, and Sander Wennekers. 2007. The relationship between economic development and business ownership revisited. *Entrepreneurship & Regional Development* 19: 281–91. [CrossRef]
- Carvalho, Luisa Margarida Gagic, and Teresa Costa. 2014. Small and Medium Enterprises (SMEs) and Competitiveness: An Empirical Study. *Journal of Management Studies* 2: 88–95.
- Civelek, Mehmet, Aleksandr Kljucnikov, Jan Dobrovic, and Maria Hudakova. 2016. A model of measurement of the quality of business environment in SME segment. *Journal of International Studies* 9: 90–102. [CrossRef]
- Council for Budget Responsibility SR. 2022. *The Structural Deficit Has Returned to Pre-Pandemic Levels*. Available online: <https://www.rz.sk/strukturalny-deficit-sa-vratil-na-urovne-spred-pandemie/> (accessed on 19 September 2022).
- Das, Subashish. 2022. Impact of COVID-19 on industries. In *COVID-19 in the Environment*. Edited by Deepak Rawtani, Chaudhery Mustansar Hussain and Nitasha Khatri. Amsterdam: Elsevier, pp. 191–200. [CrossRef]
- de Crescenzo, Annamaria, and Etienne Lepers. 2021. Extreme capital flow episodes from the Global Financial Crisis to COVID-19: An exploration with monthly data. In *OECD Working Papers on International Investment*. No. 2021/05. OECD Working Papers on International Investment. Paris: OECD Publishing. Available online: <https://ideas.repec.org/p/oec/dafaaa/2021-05-en.html> (accessed on 19 September 2022).
- Dell'Ariccia, Giovanni, Paolo Mauro, Antonio Spilimbergo, and Jeronim Zettelmeyer. 2022. *Economic Policies for the COVID-19 War*. IMF Blog. Available online: <https://www.imf.org/en/Blogs/Articles/2020/04/01/blog040120-economic-policies-for-the-covid-19-war> (accessed on 19 September 2022).
- Dvorsky, Jan, Jaroslav Schonfeld, Anna Kotaskova, and Zora Petrakova. 2018. Evaluation of important credit risk factors in the SME segment. *Journal of International Studies* 11: 204–16. [CrossRef]

- Engidaw, Amriham Ebabu. 2022. Small businesses and their challenges during COVID-19 pandemic in developing countries: In the case of Ethiopia. *Journal of Innovation and Entrepreneurship* 11: 1. [CrossRef]
- Gavurova, Beata, Jaroslav Belas, Zdenek Strnad, and Zoltan Rozsa. 2020. Impact of the state on business environment -sectoral analysis. *Journal of International Studies* 12: 244–57. [CrossRef]
- Gehrke, Brita, and Enzo Weber. 2020. Short-time work, layoffs, and new hires in Germany: How the corona crisis differs from the financial crisis of 2009. *IAB-Forum*. December 16. Available online: <https://www.iab-forum.de/en/short-time-work-layoffs-and-new-hires-in-germany-how-the-corona-crisis-differs-from-the-financial-crisis-of-2009/> (accessed on 18 September 2022).
- Gregova, Elena, and Andrey Vladimirovic Novikov. 2017. Business Environment in V4 Countries in the Context of Globalization. Paper presented at 17th International Scientific Conference Globalization and Its Socio-Economic Consequences, Rajecke Teplice, Slovakia, October 4–5; pp. 549–56. Available online: <https://www.elibrary.ru/item.asp?id=30690206> (accessed on 19 September 2022).
- Gunay, Samet. 2020. Comparing COVID-19 with the GFC: A shockwave analysis of currency markets. *Research in International Business and Finance* 56: 101377. [CrossRef]
- Gunay, Samet, and Gokberk Can. 2022. The source of financial contagion and spillovers: An evaluation of the COVID-19 pandemic and the global financial crisis. *PLoS ONE* 17: e0261835. [CrossRef]
- Haviernikova, Katarina, and Monika Mynarzova. 2018. The motivation of small and medium enterprises towards cluster cooperation from the point of view of human resources. *Socialno Ekonomicka Revue* 4: 86–93.
- Henderson, Jason, and Stephan Weiler. 2010. Entrepreneurs and Job Growth: Probing the Boundaries of Time and Space. *Economic Development Quarterly* 24: 23–32. [CrossRef]
- Juergensen, Jill, Jose Guimon, and Rajneesh Narula. 2020. European SMEs amidst the COVID-19 crisis: Assessing impact and policy responses. *Journal of Industrial and Business Economics* 47: 499–510. [CrossRef]
- Khan, Alam, Nadeem Khan, and Muhammad Shafiq. 2021. The economic impact of COVID-19 from a global perspective. *Contemporary Economics* 15: 64–76. [CrossRef]
- Klein, Aaron, and Ember Smith. 2021. Explaining the Economic Impact of COVID-19: Core Industries and the Hispanic Workforce. *Policy Briefs and Reports*, 1–18. Available online: [https://digitalscholarship.unlv.edu/brookings\\_policybriefs\\_reports/2/](https://digitalscholarship.unlv.edu/brookings_policybriefs_reports/2/) (accessed on 19 September 2022).
- Kolkova, Andrea. 2020. The Application of Forecasting Sales of Services to Increase Business Competitiveness. *Journal of Competitiveness* 12: 90–105. [CrossRef]
- Kramarova, Katarina, Lucia Svabova, and Barbora Gabrikova. 2022. Impacts of the COVID-19 crisis on unemployment in Slovakia: A statistically created counterfactual approach using the time series analysis. *Equilibrium-Quarterly Journal of Economics and Economic Policy* 17: 343–89. [CrossRef]
- Li, Zhimeng, Panteha Farmanesh, Dervis Kirikkaleli, and Rania Itani. 2022. A comparative analysis of COVID-19 and global financial crises: Evidence from US economy. *Economic Research-Ekonomika Istraživanja* 35: 2427–41. [CrossRef]
- Li, Zhimeng, Evgenii Lukin, Fangfu Sheng, and Wenkai Zeng. 2021. Assessing the Impact of the COVID-19 Pandemic on the Economies of China and Russia. *Economic and Social Changes: Facts, Trends, Forecast* 14: 277–99. [CrossRef]
- Martin, Juan Carlos, and Concepcion Roman. 2021. The effects of COVID-19 on EU federalism. *Eastern Journal of European Studies* 12: 126–48. [CrossRef]
- Meyer, Natanya, and Danie Meyer. 2016. The relationship between the creation of an enabling environment and economic development: A comparative analysis of management at local government sphere. *Polish Journal of Management Studies* 14: 150–60. [CrossRef]
- National Bank of Slovakia. 2019. *Strednodobá Predikica—4. Štvrt'rok 2019*. Bratislava: Národná Banka Slovenska. Available online: [http://www.nbs.sk/\\_img/Documents/\\_Publikacie/PREDIK/2019/protected/P4Q-2019.pdf](http://www.nbs.sk/_img/Documents/_Publikacie/PREDIK/2019/protected/P4Q-2019.pdf) (accessed on 19 September 2022).
- OECD. 2020. *Coronavirus (COVID-19): SME Policy Responses*. Available online: [https://read.oecd-ilibrary.org/view/?ref=119\\_119680-di6h3qgi4x&title=COVID-19\\_SME\\_Policy\\_Responses](https://read.oecd-ilibrary.org/view/?ref=119_119680-di6h3qgi4x&title=COVID-19_SME_Policy_Responses) (accessed on 18 September 2022).
- OECD. 2021. *Tax and Fiscal Policies after the COVID-19 Crisis*. Available online: [https://read.oecd-ilibrary.org/view/?ref=1112\\_11128\\_99-o25re5oxnb&title=Tax-and-fiscal-policies-after-the-COVID-19-crisis](https://read.oecd-ilibrary.org/view/?ref=1112_11128_99-o25re5oxnb&title=Tax-and-fiscal-policies-after-the-COVID-19-crisis) (accessed on 19 September 2022).
- Olah, Judit, Zuzana Virglerova, Jozsef Popp, Jana Kliestikova, and Sandor Kovacs. 2019. The Assessment of Non-Financial Risk Sources of SMES in the V4 Countries and Serbia. *Sustainability* 11: 4806. [CrossRef]
- Phan, Dinh, Susan Sharma, and Paresh Narayan. 2015. Stock return forecasting: Some new evidence. *International Review of Financial Analysis* 40: 38–51. [CrossRef]
- Rocha, Erick Ariel Gonzales. 2012. The Impact of the Business Environment on the Size of the Micro, Small and Medium Enterprise Sector; Preliminary Findings from a Cross-Country Comparison. *Procedia Economics and Finance* 4: 335–49. [CrossRef]
- Roziqin, Ali, Syasya Y. F. Mas'udi, and Iradhad T. Sihidi. 2021. An analysis of Indonesian government policies against COVID-19. *Public Administration and Policy-an Asia-Pacific Journal* 24: 92–107. [CrossRef]
- Slovak Business Agency. 2022. *Malé a stredné podnikanie v číslach v roku 2021 [Small and Medium-Sized Business in Numbers in 2021]*. Available online: [http://monitoringmsp.sk/wp-content/uploads/2022/07/MSP\\_v\\_cislach\\_2021\\_final.pdf](http://monitoringmsp.sk/wp-content/uploads/2022/07/MSP_v_cislach_2021_final.pdf) (accessed on 14 July 2022).
- Song, Ligang, and Yixiao Zhou. 2020. The COVID-19 Pandemic and Its Impact on the Global Economy: What Does It Take to Turn Crisis into Opportunity? *China & World Economy* 28: 1–25. [CrossRef]
- Statistical Office of the Slovak Republic. 2021. *DATAcube*. Available online: <http://datacube.statistics.sk/> (accessed on 24 May 2022).

- Statistical Office of the Slovak Republic. 2022a. *ESA 2010 GDP and Employment Flash Estimate in Q2 2022*. Available online: [https://slovak.statistics.sk/wps/portal/ext/products/informationmessages/inf\\_sprava\\_detail/64096109-abaa-4a3c-a3ee-d4808f589e13!/ut/p/z1/tVHLbslWEPyWHjhau6kdkhwNokkooAJNlB5UBgYkAScQK5S\\_r1P10gOPHroX70ozoxkPCjiD0LLONtjkhZY7e6ei\\_T72Yr\\_TcThiZ0Ax79PR1H36TFMXj9BvijSQ\\_jV\\_4STvrMQeaCuM5\\_AwFiqU1ptpAWi0puSZWTTK-JzE0L7Vlc99ZnrRWpyqOszy2sK2Vy-7YZBm0HAyIXUHm6ZJIqhrZMR\\_9tesHyqGNfLnMvpDehZ7dytvEwQvD0fLFN6Qb8oh5A0R\\_ELoY8yiZBGNKkdMfwBWN1HrwLnpwPjjVmTpBopuf2cH0jxEjhP6tVmztj8dhdx7ixytjsmz4Kmn8lb6nZx-EguK210EZ9Gpj\\_R6\\_lPtn79Ezy9bBHmVicT\\_zhCyPxxg54!/dz/d5/L2dBISEvZ0FBIS9nQSEh/](https://slovak.statistics.sk/wps/portal/ext/products/informationmessages/inf_sprava_detail/64096109-abaa-4a3c-a3ee-d4808f589e13!/ut/p/z1/tVHLbslWEPyWHjhau6kdkhwNokkooAJNlB5UBgYkAScQK5S_r1P10gOPHroX70ozoxkPCjiD0LLONtjkhZY7e6ei_T72Yr_TcThiZ0Ax79PR1H36TFMXj9BvijSQ_jV_4STvrMQeaCuM5_AwFiqU1ptpAWi0puSZWTTK-JzE0L7Vlc99ZnrRWpyqOszy2sK2Vy-7YZBm0HAyIXUHm6ZJIqhrZMR_9tesHyqGNfLnMvpDehZ7dytvEwQvD0fLFN6Qb8oh5A0R_ELoY8yiZBGNKkdMfwBWN1HrwLnpwPjjVmTpBopuf2cH0jxEjhP6tVmztj8dhdx7ixytjsmz4Kmn8lb6nZx-EguK210EZ9Gpj_R6_lPtn79Ezy9bBHmVicT_zhCyPxxg54!/dz/d5/L2dBISEvZ0FBIS9nQSEh/) (accessed on 19 September 2022).
- Statistical Office of the Slovak Republic. 2022b. *Odvetvové štatistiky: Priemysel [Sectoral Statistics: Industry]*. Available online: [https://slovak.statistics.sk/wps/portal/ext/themes/sectoral/industry/metadata!/ut/p/z1/jdDBDolwDAbgZ-EJVhiwC5woY8mCwBjgLoaTWaLowfj8GsPVQW9Nvr9tSiyZiF3mt7vOL\\_dY5tu3P9v0MqiG53mIIFFgfgqxbQbeUiMZGX-gEFjFTAFwJRKQWJkuaykFpMTuycOfQtix9wDrHz8S61txLJMNUMMKSt1EmMWiOH5nEmRfRfyrNAIIV-B70taZz7sxEzjpMAG-N3SjkA!!/dz/d5/L2djQSEvUUt3Q580TmxFL1o2X1ZMUDhCQjFBMEc3VDEwSU5OU1VWOFezOFYw/](https://slovak.statistics.sk/wps/portal/ext/themes/sectoral/industry/metadata!/ut/p/z1/jdDBDolwDAbgZ-EJVhiwC5woY8mCwBjgLoaTWaLowfj8GsPVQW9Nvr9tSiyZiF3mt7vOL_dY5tu3P9v0MqiG53mIIFFgfgqxbQbeUiMZGX-gEFjFTAFwJRKQWJkuaykFpMTuycOfQtix9wDrHz8S61txLJMNUMMKSt1EmMWiOH5nEmRfRfyrNAIIV-B70taZz7sxEzjpMAG-N3SjkA!!/dz/d5/L2djQSEvUUt3Q580TmxFL1o2X1ZMUDhCQjFBMEc3VDEwSU5OU1VWOFezOFYw/) (accessed on 15 July 2022).
- Storey, David J. 2016. *Understanding The Small Business Sector*. London: Routledge. [CrossRef]
- Szczygielski, Jan Jakub, Ailie Charteris, Princess Rutendo Bwanya, and Janusz Brzeszczyński. 2022a. The impact and role of COVID-19 uncertainty: A global industry analysis. *International Review of Financial Analysis* 80: 101837. [CrossRef]
- Szczygielski, Jan Jaku, Janusz Brzeszczyński, Ailie Charteris, and Princess Rutendo Bwanya. 2022b. The COVID-19 storm and the energy sector: The impact and role of uncertainty. *Energy Economics* 109: 105258. [CrossRef]
- Ugurlu, Erginbay, and Irena Jindrichovska. 2022. Effect of COVID-19 on International Trade among the Visegrad Countries. *Journal of Risk and Financial Management* 15: 41. [CrossRef]
- Vaskovic, Ladislav, and Daniela Siranova. 2022. *Expectations of the Business sphere: Analysis of the results of the SOPK economic survey 2021–2022 [Očakávania podnikateľskej sféry: Rozbor výsledkov ekonomického prieskumu SOPK 2021–2022]*. pp. 1–38. Available online: <https://financnenoviny.com/tag/ocakavania-podnikatelskej-sfery-rozbor-vysledkov-ekonomickeho-prieskumu-sopk-2021-2022/> (accessed on 19 September 2022).
- Valaskova, Katarina, Pavol Durana, and Peter Adamko. 2021. Changes in Consumers' Purchase Patterns as a Consequence of the COVID-19 Pandemic. *Mathematics* 9: 1788. [CrossRef]
- Versic, Sabina, Polona Tominc, and Tjasa Strukelj. 2022. SME Top Management Perception of Environmental Uncertainty and Gender Differences during COVID-19. *Sustainability* 14: 3593. [CrossRef]
- Wilkins, Peter, David Gilchrist, and John Phillimore. 2021. Independent review of emergency economic stimulus measures: Global Financial Crisis and COVID-19. *Australian Journal of Public Administration* 80: 12–28. [CrossRef]
- World Bank. 2022. *World Bank SME Finance: Development News, Research, Data*. Washington, DC: World Bank. Available online: <https://www.worldbank.org/en/topic/sme/finance> (accessed on 19 September 2022).
- Wu, Yao, Satish Nambisan, Jinghua Xiao, and Kang Xie. 2022. Consumer resource integration and service innovation in social commerce: The role of social media influencers. *Journal of the Academy of Marketing Science* 50: 429–59. [CrossRef]
- Xia, Harry, Emil Milevoj, and Marcus Goncalves. 2021. Local Response to Global Crisis—The effect of COVID-19 pandemic on SMEs and government export assistance programs in Central California. *Journal of Transnational Management* 26: 1–28. [CrossRef]
- Zamani, Salma Husna, Rahimi A. Rahman, Muhammad Ashraf Fauzi, and Liyana Mohamed Yusof. 2022. Government pandemic response strategies for AEC enterprises: Lessons from COVID-19. *Journal of Engineering, Design and Technology. ahead-of-print*. [CrossRef]

Article

# Comparative Analysis of Socioeconomic Models in COVID-19 Pandemic

Sergey Mikhailovich Vasin

Department “Economic Theory and International Relations”, Penza State University, 440026 Penza, Russia; pspu-met@mail.ru

**Abstract:** Certain features of socioeconomic models can be distinctly determined in different countries and regions. However, such models are quite flexible under external and internal influences. Their changes can be observed under the impact of unpredictable factors, the COVID-19 pandemic being one. The aim of the work is to identify differences in the structure of socioeconomic models under the influence of the pandemic. The object of the study is the socioeconomic models of various states. The subject of the study is the transformation of socioeconomic models at different stages of the pandemic. Research methods include analysis of statistical data, correlation and comparative analysis, and graphical methods of presenting results. A comparison of data from the most well-known socioeconomic models was carried out for the first time. It is determined that the countries of the Chinese model adopted restrictive measures of high Stringency Index. The countries of the Japanese model used unique crowd management methods, and the countries of the Scandinavian, German and Anglo-Saxon models resorted to unprecedented monetary injections into the social and economic spheres. It was revealed that quarantine measures eventually cost countries less than monetary injections. It was shown that a decrease in the Pandemic Uncertainty Index stabilized the economic behavior of the population and businesses and increased the volume of export-import operations. It was found that the pandemic affected the economy indirectly through the level of uncertainty and rigidity of preventive measures. It is assumed that the intensity and severity of measures could be influenced by global trends leading to certain types of preventive measures rather than by the COVID-19 statistics of a particular country.

**Keywords:** transformation; socioeconomic model; pandemic; COVID-19; Anglo-Saxon model; Rhenish (German) model; Scandinavian (Swedish) model; Japanese model; Chinese model; Stringency Index; World Pandemic Uncertainty Index

**Citation:** Vasin, Sergey Mikhailovich. 2022. Comparative Analysis of Socioeconomic Models in COVID-19 Pandemic. *Economics* 10: 278. <https://doi.org/10.3390/economics10110278>

Academic Editor: Ștefan Cristian Gherghina

Received: 19 September 2022

Accepted: 3 November 2022

Published: 8 November 2022

**Publisher’s Note:** MDPI stays neutral with regard to jurisdictional claims in published maps and institutional affiliations.



**Copyright:** © 2022 by the author. Licensee MDPI, Basel, Switzerland. This article is an open access article distributed under the terms and conditions of the Creative Commons Attribution (CC BY) license (<https://creativecommons.org/licenses/by/4.0/>).

## 1. Introduction

The socioeconomic model of the state reflects the real system of management and social relations. It also acts as an indicator of socioeconomic dynamics. It can be assumed that there are certain patterns in the change of the socioeconomic system under the influence of external or internal factors. If the impact of such factors is hard to predict, the patterns become more difficult to determine and analyze. An example of such a factor is COVID-19, which has had a serious impact on the economy of the entire planet (World Health Organization 2020). Any pandemic, being extremely unpredictable, is one of the essential prerequisites for socioeconomic changes. At the same time, the nature of the changes will depend on the degree of pandemic development.

Currently, comparative research lacks studies considering the impact of pandemics on the socioeconomic indicators of various groups of countries. We carried out a comparative analysis of countries from the most well-known socioeconomic models in the conditions of a pandemic. The phases of the pandemic were identified, which is of particular importance when assessing the impact on socioeconomic processes in society. The specifics of government spending during the pandemic, and the features of COVID-19

development in different socioeconomic models are revealed. The relationship between the COVID-19 pandemic phases and changes in the Stringency Index and World Pandemic Uncertainty Index is calculated. We also determined the correlation of pandemic indicators with export-import operations, including an increase in the turnover of computer and communication services.

The results obtained are of practical importance. The main result is data that can be used to adjust economic, social, and political measures to counteract sudden negative impacts on the society of countries of various socioeconomic models and to prevent significant negative consequences.

In research, the terms “pattern” and “model” are used. We believe that one can use the term “model” to combine similar states into groups and unify different states based on similar characteristics. We understand that states belonging to one model cannot be called identical. If that were the case, we could use the term “pattern”. As an example, we can cite an article about business model patterns, which discusses patterns that can serve as a blueprint for organizing a new business (Curtis 2021).

The remainder of the paper is organized as follows. Section 2 contains a Literature Review. Section 3 outlines the key components of the methodology: approaches, stages, and methods of analysis. Section 4 presents the key results obtained during the analysis of statistical data. Section 5 discusses the results obtained in light of earlier achievements. Section 6 contains practical conclusions, limitations, and prospects of the study.

## 2. Literature Review

Initially, the specifics of a socioeconomic model of the state depend on many factors. The determining prerequisites may be long-term geopolitical traditions, material conditions, national and socio-cultural characteristics, the influence of socio-political forces (Teterina 2015), and institutional specifics (Gubaidullina 2016). Changes in socioeconomic models and even their replacement are natural and justified since no model can constantly guarantee its effectiveness in conditions of instability (Ramazanov 2010).

The main criteria that characterize the socioeconomic model of the state and, at the same time, do not have a clear separation from each other are the following: role of the state in society, type of social policy, level of private entrepreneurship freedom, ratio of different forms of ownership, institutional features, and the openness of the economy, etc.

In turn, indicators of the state of the socioeconomic system characterizing the corresponding model are (Teterina 2015; Gubaidullina 2016): differentiation of income of the population, the share of state production in the economy, export quota (% of GDP), import quota (% of GDP), share in world exports of goods, share in world imports of goods; the ratio of the export of accumulated foreign direct investment (the value of national assets of a given country localized abroad) to GDP, the ratio of the import of accumulated foreign direct investment (the value of foreign assets created by foreign TNCs in a given country) to GDP, the share in the world export of foreign direct investment, and the share in the world import of foreign direct investment, etc.

The description of the generally recognized socioeconomic characteristics (from general to particular) is presented as a division according to specific characteristics of the well-known American, German, Swedish, Japanese, and Chinese models.

1. American (Anglo-Saxon) model is characterized by a liberal economy and high entrepreneurial activity.

Its key features are as follows (Gubaidullina 2016; Ramazanov 2010; Plyuhina 2020):

1.1. The state encourages private entrepreneurial activity as much as possible. It is reflected in

- creating the necessary conditions for business development;
- supporting entrepreneurial activity;
- limiting government intervention in the economy;
- the manifestation of low production activity of the state (low percentage of the state in the production GDP).

1.2. The low role of the state in solving social issues is manifested in the minimal participation of the state in social protection.

1.3. Free and open economic relations, including:

- tough competition in business;
- the key role of the stock market in business financing, which to a certain extent could indirectly help in surviving the pandemic due to some “habituation” to “swings on the waves of the market and the dangers of storms of stock speculation” (Kanársch 2018, p. 39);
- management in the interests of key shareholders in a context of distributed ownership;
- foreign trade openness.

1.4. Individualism in labor relations, such as:

- individual responsibility of employees;
- clear distribution of functions;
- priority of personal interests to the interests of the company;
- flexible labor markets;
- short-term hiring.

2. The Rhenish (German) model is a more socially-oriented market economy.

Its key features are as follows (Gubaidullina 2016; Ramazanov 2010; Plyuhina 2020):

2.1. Private initiative and competition, in that:

- small and medium businesses are the most important components of a market economy;
- the economy is export-oriented.

2.2. Active role of the state in the economy, including:

- support for small and medium businesses;
- high production activity of the state (high share of state-owned enterprises in the economy, a high percentage of the state in the GDP produced, and social expenditures make up a significant part of the state budget).

2.3. Efficient system of social support.

3. The Scandinavian (Swedish) model is characterized by a combination of market relations and state regulation (welfare state).

Its key features are as follows (Aksenov 2006; Tcerkasevich 2019; Gubaidullina 2016; Ramazanov 2010):

3.1. Widespread government intervention in the economy, in that:

- private property is fundamental;
- redistribution of income is a state function;
- full employment is a goal;
- income equalization is a value.

3.2. Widespread nationalization of social services and social spending comprises more than half of GDP.

3.3. Broad participation of the state in the regulation of social issues:

- solidarity policy (income equalization);
- progressive taxation.

4. The Japanese model is socially oriented with a shrinking role of the state.

Its key features are as follows (Kuznetsov 2017; Gubaidullina 2016; Ramazanov 2010; Plyuhina 2020):

4.1. Active participation of the state in social issues; developed social protection systems.

4.2. Relations of multilateral cooperation in the economy, including:

- cooperation between enterprises based on the distribution of functions;
- a key role of banks in financing enterprises;
- the equivalence of interests of shareholders and employees;
- a relative closeness of the economy to other countries;
- a low level of foreign business activity in the country;

- state as one of the largest foreign investors.
- 4.3. Cooperation in labor relations involves:
  - collective responsibility;
  - an unclear distribution of functions;
  - the loyalty of employees to the company;
  - long-term hiring.
- 5. Chinese model: Transformation towards double circulation (Tsedilin 2019; Bardhan 2020; Lukonin and Zakliazminskaia 2020).  
Its key features are as follows:
  - 5.1. Macro regulation, state planning, and control:
    - relatively high (but declining) share of the public sector (about 40%); mainly processing, energy, metallurgy, and alcohol;
    - support for the development of market relations.
  - 5.2. Development of private entrepreneurship, including:
    - strict state control;
    - annual tax audit of all enterprises;
    - free economic zones;
    - low labor costs as a competitive advantage in global markets.
  - 5.3. Export orientation, involving:
    - dependence on the external market;
    - foreign investments (the main investors are ethnic Chinese living abroad).
  - 5.4. Expansion of the domestic sales market.

It should be noted that the socioeconomic models of developed countries operating on the principles of the market economy, regardless of their uniqueness, have similar features (Gubaidullina 2016). For example, almost all of them are characterized by a sectoral structure with a significant share of industries with high added value (Vasin 2022).

In addition, after the creation of the European Union, it was reasonable to expect a convergence of the models of the various countries that formed it. In particular, more similarities began to appear in the socioeconomic systems of Sweden, Germany, France, Italy, etc. (Aksenov 2006).

What element of socioeconomic models assumes the main responsibility for adapting the system to changes? It is worth noting that such adaptation can occur in the form of resistance to change, a flexible reaction to change, or a sharp structural and institutional reshaping. Of course, the main buffer smoothing the impact of unpredictable factors is the state. However, since in traditional conditions, as shown above, the role of the state in various socioeconomic systems is different, the reaction to sudden impacts will also be ambiguous. On the one hand, conceptually, the actions of the state in different countries will be similar, but tactically there may be significant differences.

The pandemic plays the role of a sudden factor affecting the socioeconomic system, which causes changes in its socioeconomic model.

In our study, we will focus on the COVID-19 pandemic as a factor of sudden impact on society. We will not analyze the biological characteristics of the virus and the medical features of its effects on humans: these issues are covered in sufficient detail in the specialized literature (Kurrey and Saha 2022; Gueye et al. 2022; Schlickeiser and Kröger 2022; Murewanhema et al. 2022). We are interested in the specifics of the impact of COVID-19 on the socioeconomic development of society and the issues of stabilizing such an impact due to the increase in the adaptive properties of socioeconomic systems.

The aim of the study is to identify differences in the dynamics of socioeconomic models under the influence of pandemic manifestations in society. There are two bigger segments in our aim. The first is related to the speed, nature, and intensity of the reaction of the decision-making units. The second is the reaction of the system to the actions of management units. As a result of the analysis of these components in a real pandemic,

the reasons for the transformational dynamics of the socioeconomic model or its elements become clear.

The published materials contain considerable evidence of the active reaction of various states to the unpredictability of the COVID-19 pandemic. In particular, South Korea's reaction was to create an extremely detailed information field. It meant collecting the most accessible information about the sick persons or the virus carriers, their movement, purchases, and treatment in order to inform the relevant authorities and the population about the routes of their movement and to use mobile applications to prevent a healthy person from contacting a sick one. In addition, information about the pandemic was brought to everyone in the most detailed version, including the features of the virus, ways of infection, methods of prevention, etc. (Majeed 2021). In turn, Bangladesh has adopted a number of measures typical of most countries: mandatory home quarantine, social distancing, restrictions on local and international flights, closure of educational institutions, including schools, colleges, and universities, as well as the closure of offices. All this has led to national isolation (Faruk and Kar 2021). The reaction of the Nepalese Government to the occurrence of cases of the disease repeated the strict quarantine that had already become standard, which was proactive since there were fewer cases of the disease than in the United States and Europe. The quarantine was soon lifted, but then suddenly, the second wave of the pandemic in the country occurred. The lack of prompt response to its occurrence led to a deterioration in data on morbidity and mortality of the population (Paudel et al. 2021). The actions of the Government of Peru, the most affected country in Latin America, were to close schools, a number of workplaces, and public transport, cancel mass events, restrict gatherings and movement within the country, as well as increase control over international travel. The situation was complicated by the high level of informal employment. This led to internal migration due to job loss and was called "the exodus of hunger", resulting in social conflicts in the places of the arrival of migrants (Salinas et al. 2021).

Governments of states had to choose different actions and sometimes inaction because all decisions led to economic damage.

According to (Keogh-Brown et al. 2020), it was assumed that if the clinical morbidity rate was 48% and the mortality rate was 1.5%, COVID-19 alone would impose a direct health-related economic burden of 39.6 billion pounds (1.73% of GDP) on the UK economy. Mitigation strategies introduced within 12 weeks can reduce mortality by 29%, but the total cost to the economy will amount to 308 billion pounds (13.5% of GDP); 66 billion pounds (2.9% of GDP), which includes the loss of labor of working parents during school closures, and 201 billion pounds sterling (8.8% of GDP) will be accounted for by the closure of enterprises. Suppressing the pandemic for a longer period of time could reduce mortality by 95%, but the total cost to the UK economy will also increase to 668 billion pounds (29.2% of GDP), of which 166 billion pounds (7.3% of GDP) would be for school closures and 502 billion (21.9% of GDP) for enterprise closures. The researchers prove that the key to determining economic costs is the duration of the closure of schools and businesses (Keogh-Brown et al. 2020). In other words, the possible economic consequences of a pandemic will vary with different reactions of society. At the same time, these consequences will most likely depend on the current socioeconomic model of the state, that is, on the readiness of various subsystems to respond promptly. For example, the support programs launched by most European countries in 2020 were continued in 2021. At the same time, the UK already completed its support program for the population and business in October 2020 (Ivanovskiy 2021, pp. 76–77). Let us assume that changes in the current socioeconomic models are likely during the course of the pandemic both because of the high economic costs and the social perception of the course and the pandemic outcomes.

In addition, it is important to understand the development stages of the pandemic, from its appearance to its termination, to perform a detailed analysis. The specificity of pandemic influence at each stage is of particular importance.

Similar approaches to step-by-step analysis are found in research, especially in forecasting. In particular, (Lacey King et al. 2022) call this method "Multi-Level Nowcast",



implying a multi-stage prediction of the consequences of each individual reaction to a particular event. The approach is justified due to the high level of uncertainty in the context of a pandemic. It is obvious that there is no clear boundary between these stages. Nevertheless, they allow structuring the course of the pandemic by socioeconomic consequences and, accordingly, arguing the dynamics of socioeconomic models to a greater extent.

### 3. Materials and Methods

#### 3.1. Methodological Approaches

The empirical analysis in our study is presented in the following sequence.

1. Cross-sectional analysis. These are the initial positions of indicators of the socioeconomic system on a specific date in the interstate (inter-model) comparison.
2. Analysis of COVID-19 statistics and indicators of the activity response of the socioeconomic system during the pandemic life cycle. It reflects the nature and intensity of measures to prevent and combat the pandemic.
3. Analysis of the reaction indicators of a socioeconomic system to the activities of its structures due to the impact of pandemic factors.

#### 3.2. Stages and Methods of Analysis

Statistical data collection and analysis methods will be applied in the context of each stage. The following sequence will be used:

1. Selection of statistical data of countries depending on their socioeconomic model. The sample was limited by the availability of the necessary statistical data in the database of statistical services of various states or unions, in particular, integrated by Knoema® (Knoema 2020): Eurostat, Statistics Japan, U. S. Census Bureau, United Nations Economic Commission for Europe, U.S. Centers for Disease Control and Prevention, etc., statistical data from World Bank and International Monetary Fund.

Anglo-Saxon, Rhenish (German), Scandinavian (Swedish), Japanese and Chinese models were selected for the study. At the same time, data from the following states were used to form each model:

Ireland, United Kingdom, Canada, United States, Australia, and New Zealand—Anglo-Saxon model.

Belgium, Germany, Netherlands, and Switzerland—Rhenish (German) model.

Denmark, Finland, Iceland, Norway, and Sweden—Scandinavian (Swedish) model.

Indonesia, Japan, Malaysia, and South Korea—Japanese model.

China and Vietnam—Chinese model.

The relative indicators used allowed us to take into account the characteristic features of the countries included in a particular socioeconomic model. They do not include such features as territory, population, and other similar absolute indicators that distort the final arithmetic mean values calculated for the characteristics of each model.

2. Choosing the period for the analysis of COVID-19 statistics and the activity response of the socioeconomic to the impact of the COVID-19 pandemic. We considered the period from the first signs of the pandemic to the date of availability of statistical data to be indicative. As a rule, this period is from 2020 (sometimes from 2019 to 2021 and, in some cases, to 2022). In some analyses, in order to compare the period of stability with the crisis period, data from 2017 were used.

3. Collection of COVID-19 statistics and data on the activity response of the socioeconomic system according to relative and absolute, objective and subjective (if necessary) indicators for the COVID-19 pandemic in different socioeconomic systems. The analyzed indicators are as follows:

- number of new cases of SARS-CoV-2 per 1 million people (New Cases of SARS-CoV-2, Per Million People) (COVID-19 and Related Statistics 2022);
- number of new deaths from SARS-CoV-2, per 1 million people (Number of new deaths from SARS-CoV-2, Per Million People) (COVID-19 and Related Statistics 2022);

- Stringency Index—government response severity index: composite indicator based on nine response indicators, including school closures, job closures, and travel bans, scaled in value from 0 to 100, where 100 = the toughest response (Stringency Index) ([Data on COVID-19 \(Coronavirus\) by Our World in Data 2022](#); “Stringency Index” in [the Fight against the Pandemic 2022](#));
  - World Pandemic Uncertainty Index. A higher number means a higher uncertainty ([World Pandemic Uncertainty Index 2022](#));
  - General government total expenditure as a % of GDP ([IMF: World Economic Outlook \(WEO\) Database, April 2022](#)).
4. Choosing a period for analyzing the indicators of the reaction of socioeconomic systems to the impact of pandemic factors. The period from 2020 to 2022 was chosen.
5. Collection of data on the dynamics of the socioeconomic models for the period 2020–2022. The analyzed indicators are as follows:
- dynamics of exports of goods (customs at current prices) in relation to the previous quarter, % ([World Bank Global Economic Monitor 2022](#));
  - dynamics of imports of goods (customs at current prices) in relation to the previous quarter, % ([World Bank Global Economic Monitor 2022](#));
  - Stock market index calculated in US dollars (January 2000 = 100) ([World Bank Global Economic Monitor 2022](#));
  - percentage of total government expenditures in GDP, % compared to the previous year ([IMF: World Economic Outlook \(WEO\) Database, April 2022](#));
  - communications, computers, etc., in % of service exports ([World Development Indicators \(WDI\) 2022](#));
  - communications, computers, etc., in % of service imports ([World Development Indicators \(WDI\) 2022](#)).
6. Analysis of the indicators within the selected periods and conclusions about the specifics of the measures taken within each socioeconomic model. A comparative method of analysis and a graphical method of presenting the results were applied.
7. Determination of the relationship between indicators reflecting measures to combat the pandemic in different socioeconomic systems and the effectiveness of such systems during the pandemic. Application of the correlation analysis method with the calculation of correlation coefficients in the Statistica 10 environment at  $p < 0.05$
8. Conclusions on the transformation of socioeconomic models under the influence of pandemic factors.

#### 4. Results

We systematize the range of actions of national governments as an active response to the impact of pandemic factors. The main groups of measures are as follows (compiled from: [An Overview of Economic Measures Applied by Countries in the Context of the Spread of COVID-19 2020](#)):

1. Quarantine measures. They differ in form, degree of manifestation, etc., ranging from recommendations for the prevention of diseases (Sweden) to the introduction of an emergency regime (Germany). In total, these measures are combined using the Stringency Index.
2. Injection of liquidity into the economies of countries. The differences are in shapes, sizes, duration, target groups, etc. The amounts ranged from \$170 billion (PRC) to \$750 billion (UK).
3. Simplification of tax regimes: reduction of taxes and deferral of taxes and fees.
4. Reduction of reserve requirements for banks.
5. Reduction and cancellation of loan repayments and reduction of interest rates.
6. Free consulting services (opening of information portals; consulting agencies).
7. Stimulating the creation of certain types of businesses (in Japan, companies involved in the fight against the pandemic, in particular, producing protective masks, were subsidized).

8. Issuance of stabilization loans and loans to enterprises, including interest-free ones.
9. Digitalization of services: new technologies, business practices, and business models.
10. Support for export-import operations.
11. Compensation of salaries.
12. Coverage of social benefits and social payments.

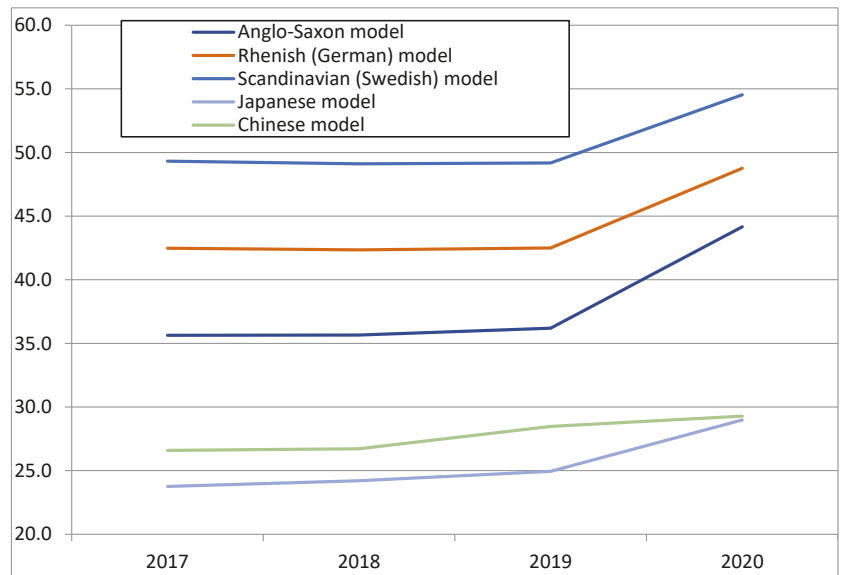
COVID-19 statistics on the most prominent representatives of the considered socio-economic models are shown in Table 1.

**Table 1.** COVID-19 statistics. (Source: [Population of the World: Data for 2022 2022](#); [World Health Organization 2022](#)).

Data	Model	1. Anglo-Saxon Model (UK and US Data)		2. Rhenish (German) Model (Data for Germany)	3. Scandinavian (Swedish) Model (Data for Sweden)	4. Japanese Model (Data for Japan)	5. Chinese Model (Data for China)
Population, people.		68,329,385	333,666,025	83,727,972	10,189,848	126,449,787	1,447,364,028
Total cases of diseases, number/% of population		23,461,939/34.3	92,364,392/27.7	31,868,639/38.1	2,558,943/25.1	17,325,025/13.7	6,163,563/0.43
Mortality, number/% of the number of cases		187,018/0.8	1,029,936/0.31	146,650/0.46	19,682/0.78	37,304/0.22	24,499/0.4

As you can see, the largest total proportion of cases on the date of access to the information resource was observed in Germany (38.1% of the population), and the smallest was in China (0.43%). However, in terms of the number of deaths, the UK and Sweden are both in first place.

The level of government spending relative to GDP is indicative in comparison to the pre-crisis period (Figure 1).



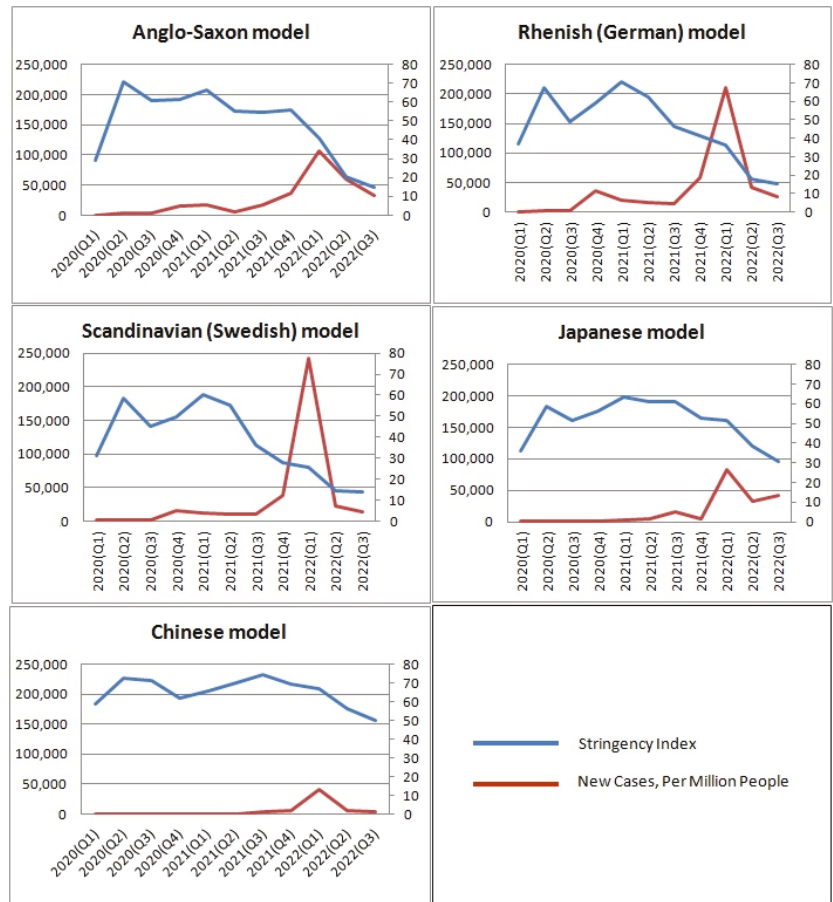
**Figure 1.** General government total expenditure in % of GDP. Source: (IMF: [World Economic Outlook \(WEO\) Database, April 2022](#); Initial data are shown in Appendix A, Table A1).

Figure 1 shows a significant relative increase in total government spending in the first year of the pandemic in the countries of all the models under consideration, except for China. This confirms the version that the state is the main buffer in the way of unpredictable factors. The explanation of the relatively low increase in government spending in the countries with the Chinese model includes: first, the earlier morbidity, before it was recognized as a

pandemic, and second, the rather high role of the state in the period “before the pandemic”, which ensured the prompt adoption of complex decisions on the prevention of morbidity with a high level of performance discipline in the population.

The Stringency Index is closely related to the increase in government spending.

The graphs (Figure 2) show the relationship between the measures taken to contain the spread of the pandemic (Stringency Index) and its quarterly new cases per one million people (New Cases, Per Million People).



**Figure 2.** Graphical relationship between the Stringency Index and the quarterly number of new cases per 1 million people. Source: (Data on COVID-19 (Coronavirus) by Our World in Data 2022; COVID-19 and Related Statistics 2022; Initial data are shown in Appendix B, Tables A2 and A3).

The absolute changes in the Stringency Index and the number of new cases differ in the countries representing the selected socioeconomic models. The ratio of these indicators also varies depending on the model. Thus, the highest Stringency Index observed in the Chinese model corresponds to the lowest incidence and, conversely, in the Scandinavian (Swedish) model, where the frequency of new cases exceeded similar indicators of other models, especially in the period 2021 (Q4)–2022 (Q1) with a relatively low Stringency Index. In general, it should be noted that there is an inverse trend of an increase in the number of new diseases relative to a decrease in compliance with preventive measures.

The degree of similarity of various socioeconomic indicators in different models during the pandemic will be shown below.

Table 2 reflects the correlation of the relative rate of increase or decrease in new cases quarterly. This is important for understanding the similarities and differences between the socioeconomic models under consideration. As you can see, there are no significant differences. Nevertheless, the dynamics in the countries of the Anglo-Saxon model were least similar to the Scandinavian (Swedish) ( $r = 0.886353$ ) and Chinese ( $r = 0.914395$ ) models. All correlation coefficients were significant at the level of  $p < 0.05$ .

**Table 2.** Correlation between the emergence of new COVID-19 cases in countries with different socioeconomic models. (number of new cases per 1 million people, the arithmetic mean of the most characteristic countries representing the model, quarterly from 2020 to 2022).

	Anglo-Saxon Model	Rhenish (German) Model	Scandinavian (Swedish) Model	Japanese Model	Chinese Model
Anglo-Saxon model	1.000000	0.925214 ( $p = 0.000045$ )	0.886353 ( $p = 0.000279$ )	0.920335 ( $p = 0.000059$ )	0.914395 ( $p = 0.000081$ )
Rhenish (German) model	0.925214 ( $p = 0.000045$ )	1.000000	0.986969 ( $p = 0.000000$ )	0.858010 ( $p = 0.000728$ )	0.974330 ( $p = 0.000000$ )
Scandinavian (Swedish) model	0.886353 ( $p = 0.000279$ )	0.986969 ( $p = 0.000000$ )	1.000000	0.854415 ( $p = 0.00081$ )	0.989803 ( $p = 0.000000$ )
Japanese model	0.920335 ( $p = 0.000059$ )	0.858010 ( $p = 0.000728$ )	0.854415 ( $p = 0.00081$ )	1.000000	0.900051 ( $p = 0.000160$ )
Chinese model	0.914395 ( $p = 0.000081$ )	0.974330 ( $p = 0.000000$ )	0.989803 ( $p = 0.000000$ )	0.900051 ( $p = 0.000160$ )	1.000000

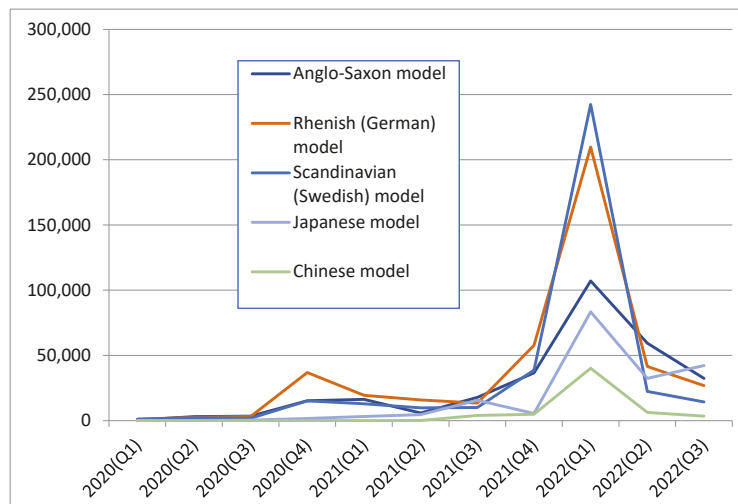
Source: (COVID-19 and Related Statistics 2022; Initial data are shown in Appendix B, Table A3).

The dynamics in the countries of the German model were least correlated with the countries of the Japanese model ( $r = 0.85801$ ).

The Japanese model is the most isolated in its specifics, while the highest correlation is observed with the countries of the Anglo-Saxon model ( $r = 0.920335$ ).

Finally, the countries of the Chinese model were least correlated with the Japanese model ( $r = 0.9$ ).

However, the absolute number of new cases per 1 million people varies significantly in different models (see Figure 3).



**Figure 3.** New Cases, Per Million People. Source: (COVID-19 and Related Statistics 2022; Initial data are shown in Appendix B, Table A3).

The smallest number of new cases in absolute numbers per 1 million people was observed in the countries of the Chinese model throughout the entire period, slightly more in the countries of the Japanese model. In relation to other models, the rating changed periodically: in the first wave of the pandemic, the largest number of cases was observed in the countries of the Rhenish model; in the last wave, it was the Scandinavian one.

Next, we analyze the mortality rate—quarterly new deaths in countries of different models per 1 million people.

Table 3 shows the correlation of the relative rate of increase or decrease in the number of new deaths in countries of different socioeconomic models on a quarterly basis. The differences in the increase or decrease of new cases were insignificant, but then there were significant differences between the models in mortality statistics. Apparently, a number of factors affect these changes. In particular, healthcare approaches are particularly important. The Rhenish ( $r = 0.760472$ ) and Scandinavian ( $r = 0.704784$ ) models correlate with the mortality dynamics in the countries of the Anglo-Saxon model; there is no correlation to the Japanese and Chinese models.

**Table 3.** Correlation between new COVID-19 deaths in countries with different socioeconomic models. (number of new deaths per 1 million people, the arithmetic mean of the most characteristic countries representing the model, quarterly from 2020 to 2022).

	Anglo-Saxon Model	Rhenish (German) Model	Scandinavian (Swedish) Model	Japanese Model	Chinese Model
Anglo-Saxon model	1.000000	0.760472 ( $p = 0.006585$ )	0.704784 ( $p = 0.015440$ )	-0.102443 ( $p = 0.764389$ )	-0.103983 ( $p = 0.760935$ )
Rhenish (German) model	0.760472 ( $p = 0.006585$ )	1.000000	0.402162 ( $p = 0.220144$ )	-0.284801 ( $p = 0.395963$ )	-0.235334 ( $p = 0.486052$ )
Scandinavian (Swedish) model	0.704784 ( $p = 0.015440$ )	0.402162 ( $p = 0.220144$ )	1.000000	-0.027743 ( $p = 0.935467$ )	-0.034043 ( $p = 0.920847$ )
Japanese model	-0.102443 ( $p = 0.764389$ )	-0.284801 ( $p = 0.395963$ )	-0.027743 ( $p = 0.935467$ )	1.000000	0.861479 ( $p = 0.000654$ )
Chinese model	-0.103983 ( $p = 0.760935$ )	-0.235334 ( $p = 0.486052$ )	-0.034043 ( $p = 0.920847$ )	0.861479 ( $p = 0.000654$ )	1.000000

Source: (COVID-19 and Related Statistics 2022; Initial data are shown in Appendix C, Table A4).

The mortality dynamics in the countries of the Rhenish model, as well as the Scandinavian one, correlates only with the countries of the Anglo-Saxon model.

The Japanese and Chinese models showed a mutual correlation ( $r = 0.861479$ ).

As we can see, comparing the data from Tables 2 and 3, there are significant differences in the dynamics of new cases and mortality. It can be concluded that there is a slight relationship between the number of new cases and new deaths per 1 million people. The exception is the Scandinavian model, countries which show a direct correlation between new cases and new deaths ( $r = 0.735013$ ).

It is likely that the level of morbidity and mortality largely depends on the features of a particular socioeconomic model and the level of severity expressed in the Stringency Index—the index of the rigidity of the government's response to threats, including those of a pandemic. Let us compare the dynamics of this indicator in different socioeconomic models (Table 4).

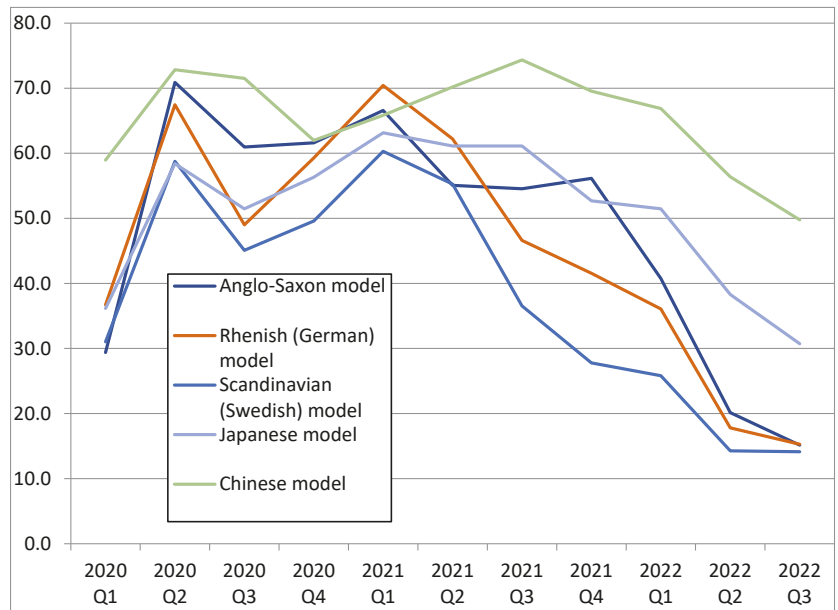
As we can see, the changes in the Stringency Index are the most correlated between the Rhenish (German) and Scandinavian (Swedish) models ( $r = 0.982387$ ), between the Anglo-Saxon and Rhenish (German) ( $r = 0.928787$ ), as well as between the Japanese and Anglo-Saxon models ( $r = 0.906539$ ). The Chinese model has the least similarity to other models, especially Scandinavian ( $r = 0.622197$ ) and Rhenish ( $r = 0.68987$ ).

However, the differences in the absolute level of the Stringency Index can be significant (Figure 4), which indicates wide discrepancies in the response of socioeconomic systems. As we mentioned earlier (see Figure 2), the most stringent measures were taken in the countries of the Chinese model (in some quarters, the figures almost reached 75), and the least stringent measures were in the Scandinavian model (they dropped to almost 14).

**Table 4.** Correlation between the Stringency Index changes in countries with different socioeconomic models (arithmetic mean of the most characteristic countries representing the model, quarterly from 2020 to 2022).

	Anglo-Saxon Model	Rhenish (German) Model	Scandinavian (Swedish) Model	Japanese Model	Chinese Model
Anglo-Saxon model	1.000000	0.928787 ( <i>p</i> = 0.000036)	0.880180 ( <i>p</i> = 0.00035)	0.906539 ( <i>p</i> = 0.000119)	0.824664 ( <i>p</i> = 0.001787)
Rhenish (German) model	0.928787 ( <i>p</i> = 0.000036)	1.000000	0.982387 ( <i>p</i> = 0.000000)	0.875780 ( <i>p</i> = 0.000409)	0.689870 ( <i>p</i> = 0.018816)
Scandinavian (Swedish) model	0.880180 ( <i>p</i> = 0.00035)	0.982387 ( <i>p</i> = 0.000000)	1.000000	0.809203 ( <i>p</i> = 0.002552)	0.622197 ( <i>p</i> = 0.040937)
Japanese model	0.906539 ( <i>p</i> = 0.000119)	0.875780 ( <i>p</i> = 0.000409)	0.809203 ( <i>p</i> = 0.002552)	1.000000	0.840277 ( <i>p</i> = 0.001203)
Chinese model	0.824664 ( <i>p</i> = 0.001787)	0.689870 ( <i>p</i> = 0.018816)	0.622197 ( <i>p</i> = 0.040937)	0.840277 ( <i>p</i> = 0.001203)	1.000000

Source: (Data on COVID-19 (Coronavirus) by Our World in Data 2022; Initial data are shown in Appendix B, Table A2).



**Figure 4.** Stringency Index. Source: (Data on COVID-19 (Coronavirus) by Our World in Data 2022; Initial data are shown in Appendix B, Table A2).

Finally, a comparison of the World Pandemic Uncertainty Index in countries belonging to different socioeconomic models showed significant differences between the models, which is proved by the correlation coefficients (Table 5).

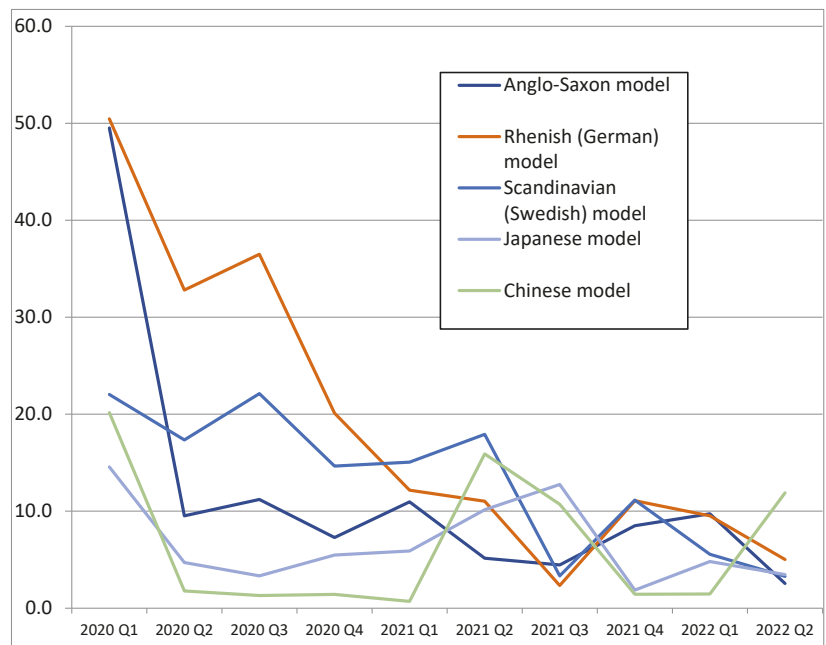
Thus, the index changes are similar, firstly, in the Anglo-Saxon and Rhenish models ( $r = 0.781554$ ) and in the Rhenish and Scandinavian models ( $r = 0.823845$ ); secondly, in the Japanese and Chinese models ( $r = 0.780222$ ). No other correlation was found.

Figure 5 indicates a general downward trend in the World Pandemic Uncertainty Index; however, the detailed differences are still significant.

**Table 5.** Correlation between the dynamics of the World Pandemic Uncertainty Index in countries belonging to different socioeconomic models (arithmetic mean of the most characteristic countries representing the model, (quarterly from 2020 to 2022).

	Anglo-Saxon Model	Rhenish (German) Model	Scandinavian (Swedish) Model	Japanese Model	Chinese Model
Anglo-Saxon model	1.000000	0.781554 ( <i>p</i> = 0.007581)	0.534053 ( <i>p</i> = 0.111809)	0.558595 ( <i>p</i> = 0.093271)	0.494488 ( <i>p</i> = 0.146257)
Rhenish (German) model	0.781554 ( <i>p</i> = 0.007581)	1.000000	0.823845 ( <i>p</i> = 0.003386)	0.227231 ( <i>p</i> = 0.527812)	0.168962 ( <i>p</i> = 0.640767)
Scandinavian (Swedish) model	0.534053 ( <i>p</i> = 0.111809)	0.823845 ( <i>p</i> = 0.003386)	1.000000	0.146814 ( <i>p</i> = 0.685679)	0.073814 ( <i>p</i> = 0.839409)
Japanese model	0.558595 ( <i>p</i> = 0.093271)	0.227231 ( <i>p</i> = 0.527812)	0.146814 ( <i>p</i> = 0.685679)	1.000000	0.780222 ( <i>p</i> = 0.007754)
Chinese model	0.494488 ( <i>p</i> = 0.145257)	0.168962 ( <i>p</i> = 0.640767)	0.073814 ( <i>p</i> = 0.839409)	0.780222 ( <i>p</i> = 0.007754)	1.000000

Source: (World Pandemic Uncertainty Index 2022).



**Figure 5.** World Pandemic Uncertainty Index. Source: (World Pandemic Uncertainty Index 2022).

In general, the lowest uncertainty was observed in the countries of the Japanese and Chinese models. The highest, especially in the first year of the pandemic, is in the countries of the Anglo-Saxon and Rhenish models.

Undoubtedly, different models of socioeconomic systems have differences both in the number of pandemic manifestations and in the nature and intensity of the activity response of various social systems. Now the question arises: how do the indicators of pandemic statistics and the activity response of socioeconomic systems relate to each other, on the one hand, and the economic consequences reflected in the dynamics of socioeconomic systems, on the other hand?

According to a number of sources (Tang et al. 2022; Habibi et al. 2022), the COVID-19 pandemic has had the most serious impact on export-import operations. However, the results of the analysis showed no correlation within each of the models under consideration between the number of new cases and the export (import) of goods, except for the Anglo-Saxon model. Here, a corresponding coefficient was found between the number of



new cases and export merchandise, customs in current prices ( $r = 0.723967$ ), and import merchandise, customs in current prices ( $r = 0.779147$ ). It is a characteristic feature of this model and a slightly later period of increase in the incidence rate than in other models. It should be noted that no reliable correlation between the number of new deaths and the volume of export-import operations (absolute and relative to the previous period) was found in any model. Moreover, the comparison of the incidence and mortality with the Stringency and Uncertainty indices did not show a reliable relationship.

In turn, in some cases, an inverse correlation was revealed between the indices of Stringency and Uncertainty, and some economic factors (Table 6).

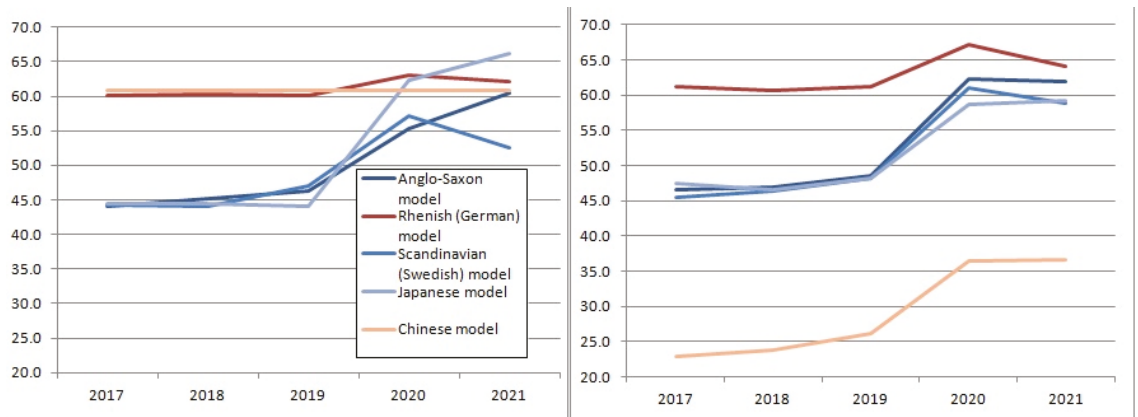
**Table 6.** Correlation between Stringency and Uncertainty indices and some economic indicators of socioeconomic models.

	Anglo-Saxon Model	Rhenish (German) Model	Scandinavian (Swedish) Model	Japanese Model	Chinese Model
Exports merchandise, customs in current prices and Stringency Index	-0.673525 ( $p = 0.032756$ )	-0.508312 ( $p = 0.133570$ )	-0.701661 ( $p = 0.023728$ )	-0.110885 ( $p = 0.760399$ )	-0.001509 ( $p = 0.996699$ )
Exports merchandise, customs in current prices and World Pandemic Uncertainty Index	-0.284511 ( $p = 0.425611$ )	-0.790548 ( $p = 0.006483$ )	-0.814360 ( $p = 0.004126$ )	-0.107848 ( $p = 0.766806$ )	-0.223653 ( $p = 0.534505$ )
Import merchandise, customs in current prices and World Pandemic Uncertainty Index	-0.417379 ( $p = 0.230100$ )	-0.784667 ( $p = 0.007187$ )	-0.765969 ( $p = 0.009786$ )	-0.153315 ( $p = 0.672396$ )	0.021100 ( $p = 0.953865$ )
World Pandemic Uncertainty Index and Stock market index calculated in US dollars (Jan. 2000 = 100)	-0.422843 ( $p = 0.223425$ )	-0.798651 ( $p = 0.005595$ )	-0.661625 ( $p = 0.037191$ )	-0.013367 ( $p = 0.970765$ )	-0.055899 ( $p = 0.878102$ )

Source: (COVID-19 and Related Statistics 2022; World Pandemic Uncertainty Index 2022; World Bank Global Economic Monitor 2022).

The analysis of Table 6 shows that the most noticeable relationship between the indicators of the Stringency Index, as well as the Global Uncertainty Index and some economic indicators presented here (Exports merchandise, Import merchandise, Stock market index), is determined within the Scandinavian (Swedish), as well as the Rhenish (German) models (reliable correlation coefficients are shown in red at  $p < 0.05$ ).

It is noteworthy that since the beginning of the pandemic crisis, there has been a sharp increase in the indicators of Communications, Computers, etc., as a percentage of service exports and Communications, Computer, etc., as a % of service imports for each of the models under consideration (Figure 6).



**Figure 6.** Communications, computer, etc. in % of service exports (left) and Communications, computer, etc., as a percentage of service imports (right). Source: (World Development Indicators (WDI) 2022; Initial data are shown in Appendix D, Tables A5 and A6).

The main prerequisite for such growth was the global and abrupt development of remote technologies, requiring the production of appropriate services. We should note that

in the countries of the Chinese model, there was no growth in exports of these services in total, but imports increased significantly.

## 5. Discussion

First of all, we will identify the signs of the reaction of socioeconomic systems that occur during the period of exposure to unexpected factors and that are characteristic of all countries and regions. The most difficult thing in finding patterns of behavior of the socioeconomic system in response to the large-scale influence of unexpected factors is the choice of the right actions. This choice is most often carried out by current monitoring of the results of the measures taken. In the event that there are no noticeable improvements, the actions are enhanced or replaced by others.

If we take the pandemic as a factor of unexpected impact, then one can expect similar intuitive activity reactions based on the expectation of changes in the models of socioeconomic systems. The most notable changes include the following:

1. Increase in the level of morbidity, mortality, and a decrease in the birth rate.
2. Significant strengthening of the role of the state in all areas is reflected in the socioeconomic model.
3. Development of industries related to remote technologies for the production of goods and services.
4. Increased migration of the population: from a foreign country to the homeland and to other countries from places with the worst demographic indicators.
5. Significant changes in the trade balance of countries (Habibi et al. 2022).

We suggest identifying several phases of the pandemic to have a clearer idea of socioeconomic systems' reactions. At the same time, it should be noted that the main differences between countries belonging to different socioeconomic models will be in the strength of a particular reaction in the designated phases.

Phase 1. The feeling of threat, recording of the first cases of diseases and deaths, the appearance of fear and panic among the population, and primary decisions of the government and the market to prevent diseases.

Phase 2. A sharp increase in morbidity and mortality, the introduction of compulsory measures to prevent the disease, restrictions on the work of enterprises and organizations to a complete stop of activity, the development of tests and vaccines, the introduction of testing and vaccination, and panic among the population.

Phase 3. Reduction of morbidity and mortality with periodic peaks of incidence, free or inexpensive vaccination in order to reach the threshold of collective immunity, isolation, quarantine measures, the emergence of contradictions in society on vaccination, and other preventive measures. Introduction of interregional and interstate export-import restrictions and breaks in value chains in the production of goods. Decrease in population income.

Phase 4. A slight increase in the number of cases and deaths, overstocking of production facilities with intermediate-stage products, shortage of end-use products, inflation, mass closure of enterprises and organizations in the real sector of the economy, and an increase in unemployment.

Phase 5. The reduction in mortality and incidence, continued isolation, the development of alternative production options, and the search for import substitution opportunities.

Phase 6. New cases are episodic, isolated in nature, and mortality is low. There is a shortage of imported intermediate and finished goods, a limited possibility of export operations, activation of national production potential, and stabilization of the updated form of the socioeconomic model.

It should be noted that in some, often unclear conditions, repeated waves of the pandemic occur with a complete or partial repetition of its life cycle.

Now we will discuss the revealed differences in the behavior of groups of states belonging to different socioeconomic models.

As we noted earlier, the incidence ratio to the population of states built according to different socioeconomic principles, as well as the death ratio, vary. It depends on a number

of factors, one of which is the nature of the state's activity response. In most cases, shares of government spending increase, but the type and direction of spending can vary significantly. For example, public spending in the countries of the Anglo-Saxon model, which is normally relatively small compared to countries of other models, was unprecedentedly high during the COVID-19 pandemic, and the types of spending are very diverse: in fact, all more or less common measures were applied. On the other hand, the countries of the Japanese model had an unconventional activity reaction of the state, for example, the so-called crowd control, the purpose of which was to separate the flows of people from each other as much as possible in order to avoid mixing healthy people with sick people. To this end, government spending was directed to the creation of special software tools (Durán-Polanco and Siller 2021), while in England, the analysis of the population mobility based on their smartphones was carried out only for research purposes and after the end of the main phases of the pandemic (Lee et al. 2021).

At the same time, the role of the state implied not only financial injections into the economy and social sphere. Discussing the impact of a set of strict measures integrated into the form of the Stringency Index, it can be noted that the use of such measures is strongly characteristic of the Chinese model. Statistics show that it costs the state less than direct or indirect financial injections. Of course, the stricter the measures, the more the economy declines, but in practice, the economic recovery is quite fast (Li et al. 2022; Teng et al. 2022), and at the same time, human lives and health are preserved, unlike the greater morbidity and mortality of countries of other models. The countries of the Japanese model with a lower Stringency Index (versus the countries of the Chinese model) and a relatively low incidence were the exceptions due to the special measures taken by these states.

The dynamics of incidence were important in cross-model comparison. Evidently, the smallest correlation was found between those models that were unique in preventing the spread of the pandemic. However, despite the fact that models with similar dynamics were identified, their comparison by the absolute number of new cases per 1 million people showed significant differences. On the one hand, these two indicators characterize global trends and, on the other hand, the specifics of the local development of the pandemic. This enables us to pay special attention to the measures taken by the more successful countries in the fight against the pandemic, representing the Chinese and Japanese models.

The findings also confirm the results of the analysis of new deaths: the countries of the Chinese and Japanese models have the most favorable dynamics, which distinguishes them from the Anglo-Saxon, Rhenish, and Scandinavian models. It should be noted that the dynamics of new cases were similar between all models. However, the dynamics of mortality differed significantly in different models. We should also note the absence of a correlation between the number of new cases and deaths (except for the Scandinavian model). The measures taken in a number of cases were justified, which shows the great resilience of the Japanese and especially the Chinese models to sudden external factors.

We also note the importance of increasing the level of certainty as opposed to the Uncertainty Index during the pandemic. Certainty and predictability reduce panic and stabilize the economic behavior of the population.

A controversial and unexpected result was the absence in most cases of a confirmed statistical relationship between the number of new cases and deaths and the export-import operations within the countries of the same model. These facts may indicate that the impact of pandemic factors on the economy is indirect. In other words, the number of cases and deaths can only cause a high level of uncertainty and rigidity of preventive measures, which, in turn, affect the country's economy.

Another unexpected result was the lack of a link between morbidity and mortality rates and the stringency of measures. We believe this may indicate that the stringency of measures could be influenced by global trends provoking total prevention measures rather than by the COVID-19 statistics of a particular state (model). We think that similar results would be obtained when comparing these indicators in individual countries. We assume

that it would hardly be consistent if a reliable correlation between new COVID-19 cases and the severity of measures was revealed within some countries.

Moreover, the stringency of the measures taken by the countries of the Japanese and Chinese models did not show a statistical connection with the export of goods. Apparently, the reason for this was the relatively passive dynamics of the Stringency Index (consistently high), which led to the lack of correlation. This conclusion is supported by a confirmed inverse correlation with the Stringency Index of the Anglo-Saxon and Scandinavian models. The high dynamics of this index can be seen above (Figure 2).

An interesting finding was the feedback between the dynamics of exports and imports of goods and the level of uncertainty within the Rhenish and Scandinavian models, which may indicate the suspension of international trade operations in a situation of unpredictable forecasts. This shows that it is highly important to work on increasing predictability in order to stabilize the entire socioeconomic system, which is confirmed by the revealed relationship with stock market indices in the same models.

At the same time, we should note the spike in export-import operations of computer services and communication services at the peak of the pandemic, which at present and in the future can be recognized as a natural reaction when any pandemic factors appear since remote technologies provide the best opportunity to remain socially active, and at the same time comply with isolation requirements.

Most of the changes outlined above led to the deglobalization of the economy.

## 6. Conclusions

This work partially closes the gap in the comparative analysis of socioeconomic models of states in terms of their reaction to the unforeseen impact of unpredictable factors. We also highlight the course of the pandemic in countries from different socioeconomic models, which allows us to identify the connection between the pandemic and actions taken within a particular model.

The study can be used to adjust the strategy of socioeconomic development in the event of a sudden pandemic. In particular, the most universal measures identified in the study include:

1. Enhanced quarantine measures are used to accelerate the localization of the disease and prevent its spreading. It will have a less negative impact on the economy and will contribute to its accelerated recovery. This also applies to the promptness of measures, implying their adoption in case of tension in foreign countries. In other words, actions should be proactive.
2. Flexible quarantine measures imply using crowd management methods when the main goal is not absolute isolation of a person but reducing the risk of healthy people contacting the sick.
3. Reducing the level of uncertainty and panic, which has a positive impact on the economic behavior of the population, its reasonableness, and prompting citizens to leave the zones of infection. In addition, a low level of uncertainty will cause an increase in entrepreneurial activity, including the development of export-import operations, which will strengthen global business networks.

The study has limitations. First of all, in order to determine the characteristics of each socioeconomic model, the characteristics of the countries included therein were mediated, which inevitably leads to an error in the individual assessment of the development of each country included in a particular model. Second, it cannot be claimed that the COVID-19 pandemic has come to an end, which means that adjustments in the dynamics of socioeconomic models are possible in the future. Third, it would be a mistake to talk about the sharp boundaries of differences between socioeconomic models from one another—all models have common features and uniqueness, which allows for errors in analysis, forecasts, and recommendations.

The study can be developed further. First, we can expand the list of socioeconomic models of the countries in order to find new effective structures that successfully perceive

unpredictable impacts. Second, the analysis should be continued as new statistical data are published, which will allow us to present the dynamics in more complete stages of the pandemic. Finally, each model can be considered in greater detail, analyzing smaller elements, which can reveal the unique properties of the model that contribute to reflecting the impact of sudden factors, such as a pandemic.

**Funding:** This research was funded by the Russian Science Foundation, grant number 22-28-01976. Available online: <https://rscf.ru/project/22-28-01976/> (accessed on 10 January 2022).

**Informed Consent Statement:** Not applicable.

**Data Availability Statement:** Knoema 2020; World Bank Global Economic Monitor 2022; World Development Indicators 2022; World Health Organization 2022; World Pandemic Uncertainty Index 2022.

**Conflicts of Interest:** The author declares no conflict of interest.

## Appendix A

**Table A1.** General government total expenditure as a percentage of GDP.

	2017	2018	2019	2020
<b>Anglo-Saxon model</b>	<b>35.6</b>	<b>35.7</b>	<b>36.2</b>	<b>44.2</b>
Ireland	26.406	25.6	24.53	28.71
United Kingdom	39.26	39.004	38.869	50.273
Canada	40.455	40.866	40.956	52.449
United States	35.352	35.423	35.681	46.179
Australia	36.776	36.869	38.287	44.981
New Zealand	35.605	36.175	38.818	42.423
<b>Rhenish (German) model</b>	<b>42.5</b>	<b>42.3</b>	<b>42.5</b>	<b>48.8</b>
Belgium	52.0	52.2	52.1	60.8
Germany	44.2	44.5	45.2	51.1
Netherlands	41.7	41.5	41.3	46.9
Switzerland	32.0	31.3	31.5	36.3
<b>Scandinavian (Swedish) model</b>	<b>49.3</b>	<b>49.1</b>	<b>49.2</b>	<b>54.5</b>
Denmark	50.6	50.5	49.2	55.1
Finland	53.6	53.3	53.4	56.7
Iceland	44.5	44.0	43.4	49.7
Norway	49.6	48.9	51.6	58.2
Sweden	48.3	48.8	48.3	53.1
<b>Japanese model</b>	<b>23.8</b>	<b>24.2</b>	<b>24.9</b>	<b>29.0</b>
Indonesia	16.6	16.6	16.4	18.2
Japan	36.9	37.0	37.2	46.7
Malaysia	21.9	22.8	23.5	25.4
South Korea	19.6	20.4	22.6	25.6
<b>Chinese model</b>	<b>26.6</b>	<b>26.7</b>	<b>28.5</b>	<b>29.3</b>
China	31.6	32.9	34.1	37.0
Vietnam	21.5	20.5	22.8	21.6

Source: own elaboration based on (IMF: World Economic Outlook (WEO) Database, April 2022).

## Appendix B

Table A2. Stringency Index.

	2020 Q1	2020 Q2	2020 Q3	2020 Q4	2021 Q1	2021 Q2	2021 Q3	2021 Q4	2022 Q1	2022 Q2	2022 Q3
<b>Anglo-Saxon model</b>	<b>29.4</b>	<b>70.9</b>	<b>61.0</b>	<b>61.6</b>	<b>66.6</b>	<b>55.1</b>	<b>54.5</b>	<b>56.1</b>	<b>40.7</b>	<b>20.1</b>	<b>15.1</b>
Ireland	39.18	81.85	53.34	73.1	86.16	65.26	41.4	41.77	20.64	8.85	11.02
United Kingdom	23.69	74.9	66.2	69.54	84.67	59.53	44.8	43.05	31.24	12.86	11.11
Canada	19.47	72.6	66.28	69.25	74.53	74.55	65.3	63.65	58.11	21.44	17.7
United States	22.5	72.04	66.56	68.51	67.76	56.3	51.22	50.86	42.68	27.59	24.32
Australia	27.03	64.52	73.2	65.73	57.87	52.62	70.07	64.53	43.93	29.99	11.36
New Zealand	44.41	59.51	40.22	23.46	28.44	22.22	54.47	72.99	47.88	20.12	15.35
<b>Rhenish (German) model</b>	<b>36.7</b>	<b>67.5</b>	<b>49.0</b>	<b>59.3</b>	<b>70.4</b>	<b>62.2</b>	<b>46.6</b>	<b>41.6</b>	<b>36.1</b>	<b>17.8</b>	<b>15.3</b>
Belgium	31.84	71.75	54.06	58.33	62.41	57.26	47.03	34.1	30.58	20.96	20.96
Germany	28.22	67.3	55.12	64.31	80.97	72.6	61.32	45.5	44.3	22.82	14.81
Netherlands	42.26	71.15	45.1	64.4	78.17	67.59	40.14	45.87	40.92	16.28	15.65
Switzerland	44.44	59.66	41.76	50.06	60.19	51.36	37.94	40.75	28.51	11.11	9.7
<b>Scandinavian (Swedish) model</b>	<b>31.0</b>	<b>58.8</b>	<b>45.1</b>	<b>49.6</b>	<b>60.3</b>	<b>55.3</b>	<b>36.5</b>	<b>27.8</b>	<b>25.8</b>	<b>14.3</b>	<b>14.1</b>
Denmark	28.22	64.82	52.82	46.57	65.87	58.48	37.35	28.42	20.03	11.11	11.11
Finland	29.4	57.89	34.22	42.9	52.31	51.02	38.45	29.49	30.34	26.85	26.24
Iceland	34.54	47.2	42.01	49.51	45.08	43.89	28.54	33.9	26.61	11.11	11.11
Norway	42.05	60.2	38.9	48.07	68.93	61.72	42.06	28.84	26.1	11.11	11.11
Sweden	20.91	63.71	57.45	60.85	69.35	61.18	36.31	18.25	25.96	11.11	11.11
<b>Japanese model</b>	<b>36.1</b>	<b>58.4</b>	<b>51.5</b>	<b>56.3</b>	<b>63.2</b>	<b>61.1</b>	<b>61.1</b>	<b>52.7</b>	<b>51.5</b>	<b>38.3</b>	<b>30.7</b>
Indonesia	42.25	70.37	62.99	59.77	69.09	71.76	71.18	62.31	63.44	42.86	28.11
Japan	27.66	38.54	31.66	38.29	47.64	49.23	51.27	47.22	46.99	43.14	37.53
Malaysia	31.76	70.23	58.6	69.77	73.69	70.48	74.44	56.41	52.33	48.53	43.39
South Korea	42.9	54.5	52.62	57.47	62.21	53.02	47.58	44.85	43.11	18.68	13.89
<b>Chinese model</b>	<b>59.0</b>	<b>72.8</b>	<b>71.5</b>	<b>62.0</b>	<b>65.8</b>	<b>70.2</b>	<b>74.4</b>	<b>69.5</b>	<b>66.9</b>	<b>56.4</b>	<b>49.8</b>
China	75.45	71.17	72.32	70.47	68.25	71.47	73.13	71.83	67.74	78.66	73.61
Vietnam	42.46	74.51	70.7	53.49	63.41	68.89	75.58	67.25	65.99	34.09	25.93

Source: own elaboration based on (Data on COVID-19 (Coronavirus) by Our World in Data 2022).

Table A3. New Cases of COVID-19, Per Million People.

	2020(Q1)	2020(Q2)	2020(Q3)	2020(Q4)	2021(Q1)	2021(Q2)	2021(Q3)	2021(Q4)	2022(Q1)	2022(Q2)	2022(Q3)
<b>Anglo-Saxon model</b>	<b>395.6</b>	<b>3026.2</b>	<b>3438.3</b>	<b>15,204.8</b>	<b>16,305.6</b>	<b>5825.9</b>	<b>17,770.7</b>	<b>36,619.6</b>	<b>10,7157.9</b>	<b>59,370.7</b>	<b>32,373.5</b>
Ireland	648.7	4459.6	2142.2	11,154.9	28,892.9	7234.9	24,246.7	79,940.8	135,645.1	28,314.1	10,974.4
United Kingdom	572.0	3644.8	2520.1	30,253.9	27,600.8	6871.8	44,680.2	76,260.0	109,424.1	23,436.8	11,482.1
Canada	280.7	2460.9	1518.9	11,209.2	10,494.4	11,245.9	5484.9	15,586.7	33,185.0	12,592.6	6118.9
United States	570.0	7290.3	13,646.4	38,498.6	30,744.5	9504.5	28,957.5	33,734.2	75,162.6	22,109.0	19,262.4
Australia	175.9	129.7	739.8	51.3	34.6	51.0	2952.7	12,280.2	161,142.9	138,559.3	70,695.1
New Zealand	126.1	172.1	62.4	61.2	66.5	47.2	302.0	1915.7	128,387.7	131,212.4	75,707.9
<b>Rhenish (German) model</b>	<b>1132.8</b>	<b>2404.3</b>	<b>3194.9</b>	<b>36,873.9</b>	<b>19,424.5</b>	<b>15,846.9</b>	<b>13,468.4</b>	<b>57,792.6</b>	<b>209,796.0</b>	<b>41,491.9</b>	<b>26,799.5</b>
Belgium	1100.2	4190.0	4911.1	45,476.3	20,321.1	17,455.1	13,764.3	74,098.5	150,343.8	34,020.8	19,953.8
Germany	742.3	1586.7	1138.5	17,150.7	13,057.8	11,021.3	5986.9	35,043.4	170,326.3	83,168.0	44,928.1
Netherlands	778.2	2102.2	4248.3	38,959.4	27,195.6	23,189.3	18,318.4	65,391.7	269,430.4	18,607.4	11,259.2
Switzerland	1910.5	1738.4	2481.5	45,909.0	17,123.6	11,721.9	15,804.0	56,636.6	249,083.3	30,171.3	31,056.8
<b>Scandinavian (Swedish) model</b>	<b>1035.2</b>	<b>2274.8</b>	<b>1783.3</b>	<b>15,107.0</b>	<b>12,853.1</b>	<b>9795.6</b>	<b>10,025.5</b>	<b>38,720.7</b>	<b>242,436.7</b>	<b>22,401.2</b>	<b>14,298.9</b>
Denmark	488.5	1692.4	2601.5	23,142.4	11,807.7	10,774.1	11,123.4	75,774.3	385,425.9	19,301.1	16,665.2
Finland	302.0	1009.2	538.3	4729.6	7518.3	3245.3	8327.5	23,251.3	110,702.3	47,314.7	20,445.8
Iceland	3064.8	1860.5	2441.0	8171.0	1220.5	1198.9	13911.7	41,200.5	416,736.2	34,749.6	27,761.4
Norway	859.0	784.4	952.8	6577.8	8608.5	6521.7	10,756.0	37,909.9	187,247.3	7645.7	2301.3
Sweden	461.8	6027.5	2382.6	32,914.2	35,110.7	27,238.1	6008.9	15,467.3	112,072.0	2994.8	4320.6
<b>Japanese model</b>	<b>73.7</b>	<b>141.4</b>	<b>413.5</b>	<b>1662.5</b>	<b>3115.1</b>	<b>4547.4</b>	<b>15,552.0</b>	<b>5464.1</b>	<b>83,479.4</b>	<b>32,404.1</b>	<b>42,211.9</b>
Indonesia	5.6	200.4	842.5	1666.4	2807.3	2434.9	7440.4	173.9	6393.0	276.3	930.1
Japan	18.1	131.2	521.4	1221.1	1920.7	2604.0	7266.4	218.5	38,706.3	22,159.6	72,683.5
Malaysia	82.4	174.9	77.0	3031.7	6924.7	12,107.0	44,490.4	15,261.6	43,004.7	10,845.8	6193.7
South Korea	188.8	59.1	213.0	730.9	807.8	1043.5	3010.8	6202.6	245,813.8	96,334.7	89,040.1
<b>Chinese model</b>	<b>30.0</b>	<b>2.1</b>	<b>5.0</b>	<b>3.1</b>	<b>7.6</b>	<b>75.2</b>	<b>3971.1</b>	<b>4827.4</b>	<b>40,223.8</b>	<b>6294.5</b>	<b>3381.4</b>
China	57.9	2.8	2.3	2.3	3.4	2.1	4.1	5.4	79.1	463.3	41.3
Vietnam	2.2	1.5	7.6	3.8	11.7	148.2	7938.0	9649.3	80,368.4	12,125.6	6721.5

Source: own elaboration based on (COVID-19 and Related Statistics 2022).

## Appendix C

Table A4. New Deaths, Per Million People.

	2020 Q1	2020 Q2	2020 Q3	2020 Q4	2021 Q1	2021 Q2	2021 Q3	2021 Q4	2022 Q1	2022 Q2	2022 Q3
<b>Anglo-Saxon model</b>	<b>18.6</b>	<b>281.3</b>	<b>55.5</b>	<b>204.0</b>	<b>354.2</b>	<b>56.0</b>	<b>89.0</b>	<b>135.6</b>	<b>210.3</b>	<b>129.3</b>	<b>93.1</b>
Ireland	14.2	334.7	14.7	88.2	491.3	63.0	50.3	133.0	168.7	149.6	64.4
United Kingdom	76.4	758.9	38.4	538.2	857.2	29.8	141.4	194.5	218.1	123.6	64.6
Canada	4.0	224.6	16.3	167.6	189.3	87.4	41.1	64.4	200.1	114.1	55.2
United States	15.9	362.2	233.0	429.1	587.1	155.5	285.3	381.8	468.0	102.9	78.3
Australia	0.7	3.4	30.2	0.8	0.0	0.0	15.6	36.3	144.9	137.8	147.3
New Zealand	0.2	4.3	0.6	0.0	0.4	0.0	0.2	3.7	61.8	147.8	148.7
<b>Rhenish (German) model</b>	<b>45.7</b>	<b>330.6</b>	<b>17.3</b>	<b>518.9</b>	<b>350.0</b>	<b>121.1</b>	<b>33.2</b>	<b>185.9</b>	<b>162.4</b>	<b>71.3</b>	<b>37.2</b>
Belgium	60.7	778.7	33.2	819.2	300.4	185.8	36.9	235.0	214.9	94.0	49.8
Germany	7.0	100.6	6.3	282.7	518.8	174.2	33.1	219.2	213.2	137.8	70.9
Netherlands	59.4	290.8	18.4	287.5	291.7	69.3	26.2	157.9	61.4	22.4	12.4
Switzerland	55.8	152.3	11.4	686.3	288.9	55.0	36.6	131.6	160.0	30.8	15.5
<b>Scandinavian (Swedish) model</b>	<b>14.8</b>	<b>138.2</b>	<b>14.1</b>	<b>102.2</b>	<b>148.1</b>	<b>34.9</b>	<b>17.7</b>	<b>67.5</b>	<b>253.7</b>	<b>144.0</b>	<b>89.8</b>
Denmark	15.4	89.0	7.7	110.7	191.5	19.7	20.8	94.1	415.2	131.7	72.4
Finland	9.2	46.6	3.6	47.5	52.4	18.4	24.2	107.7	225.1	312.7	126.8
Iceland	5.4	21.6	0.0	51.3	0.0	2.7	8.1	10.8	175.5	51.3	70.2
Norway	7.2	39.0	4.4	30.0	43.9	22.6	12.4	82.4	161.0	151.6	114.0
Sweden	36.8	494.9	54.6	271.6	452.7	111.2	22.8	42.6	291.9	72.5	65.5
<b>Japanese model</b>	<b>1.4</b>	<b>5.4</b>	<b>9.1</b>	<b>19.2</b>	<b>38.4</b>	<b>57.8</b>	<b>241.8</b>	<b>56.9</b>	<b>108.5</b>	<b>52.1</b>	<b>28.8</b>
Indonesia	0.499	10.009	28.729	41.634	68.383	64.411	304.827	7.872	40.163	6.021	2.763
Japan	0.536	7.265	4.808	15.372	45.614	44.996	22.992	5.933	78.09	25.334	60.576
Malaysia	1.431	2.184	0.45	9.979	23.856	116.098	630.399	153.45	104.127	23.293	12.835
South Korea	3.126	2.313	2.561	9.684	15.78	5.518	9.181	60.352	211.554	153.678	38.862
<b>Chinese model</b>	<b>2.3</b>	<b>0.0</b>	<b>0.2</b>	<b>0.0</b>	<b>0.0</b>	<b>0.2</b>	<b>98.6</b>	<b>67.2</b>	<b>51.8</b>	<b>3.3</b>	<b>0.1</b>
China	2.3	0.0	0.0	0.0	0.0	0.0	0.0	0.0	0.0	0.4	0.0
Vietnam			0.4	0.0	0.0	0.5	197.2	134.3	103.6	6.1	0.2

Source: own elaboration based on (COVID-19 and Related Statistics 2022).

## Appendix D

Table A5. Communications, computer, etc. as a % of service exports.

	2017	2018	2019	2020	2021
<b>Anglo-Saxon model</b>	<b>44.2</b>	<b>45.2</b>	<b>46.3</b>	<b>55.3</b>	<b>60.4</b>
Ireland	75.05733718	78.39089583	80.56090528	84.74048791	85.84943511
United Kingdom	51.73400862	53.59555737	54.3556805	61.04554527	61.35376748
Canada	49.14219131	51.07201149	51.83397138	62.60320658	63.47158469
United States	48.4486822	48.31342932	49.22303739	58.29486981	58.43605712
Australia	21.34883929	21.10219424	21.92888586	34.1336442	46.69816482
New Zealand	19.19337286	18.5622856	19.94700922	30.84307169	46.76756499
<b>Rhenish (German) model</b>	<b>60.1</b>	<b>60.2</b>	<b>60.0</b>	<b>63.1</b>	<b>62.2</b>
Belgium	62.39909403	62.14700282	62.60034489	63.81248449	62.73845421
Germany	57.22498312	57.61653953	57.54207168	62.30480882	60.81586752
Netherlands	67.76506205	66.44139947	66.90268709	71.48285284	68.67899707
Switzerland	53.21018729	54.66971257	53.0994684	54.87344565	56.64012863
<b>Scandinavian (Swedish) model</b>	<b>44.3</b>	<b>44.1</b>	<b>47.0</b>	<b>57.1</b>	<b>52.5</b>
Denmark	34.66869238	36.48714019	35.16161734	36.79874231	29.55980655
Finland	71.77170932	71.05126601	73.08927911	84.32100277	84.76089425
Iceland	15.77228251	15.57357165	22.09320861	47.8338883	35.59355701
Norway	33.22450984	32.89905355	35.26015201	41.06454886	40.58221579
Sweden	66.31018683	64.61295781	69.47537803	75.67737515	72.02660513
<b>Japanese model</b>	<b>44.5</b>	<b>44.4</b>	<b>44.1</b>	<b>62.3</b>	<b>66.2</b>
Indonesia	31.56129706	33.22324465	32.07659137	55.83153732	65.63389296
Japan	56.68290955	56.36117915	57.57903174	69.85898198	73.093649
Malaysia	36.15409261	36.33395338	36.56132658	66.93479457	76.54224781
South Korea	53.72787239	51.60232452	50.13082766	56.75361652	49.55457416
<b>Chinese model</b>	<b>60.9</b>	<b>60.9</b>	<b>60.9</b>	<b>60.9</b>	<b>60.9</b>
China	60.88352357	60.88352357	60.88352357	60.88352357	60.88352357
Vietnam	...	...	...	...	...

Source: own elaboration based on (World Development Indicators (WDI) 2022). ... —no data.

**Table A6.** Communications, computer, etc. as a % of service imports.

	2017	2018	2019	2020	2021
<b>Anglo-Saxon model</b>	<b>46.6</b>	<b>46.9</b>	<b>48.5</b>	<b>62.4</b>	<b>61.9</b>
Ireland	83.81065257	81.93914316	86.22825975	86.99577811	85.14069696
United Kingdom	49.66916088	51.2649503	52.07493961	69.29383135	66.47186585
Canada	38.15118669	40.48536832	42.37828907	55.8637609	58.35493615
United States	44.3759709	43.28663107	42.66385393	55.2272431	50.96960381
Australia	27.04156365	27.28019663	28.03761011	53.11261441	57.37615398
New Zeland	36.50517535	37.1990325	39.86840086	53.66720374	53.26019589
<b>Rhenish (German) model</b>	<b>61.2</b>	<b>60.7</b>	<b>61.2</b>	<b>67.2</b>	<b>64.1</b>
Belgium	54.63510949	54.37495686	55.73224996	60.17961604	57.24475382
Germany	49.75304378	49.58028062	50.77431769	58.67686619	54.51614024
Netherlands	68.47091713	67.57137015	66.56505073	71.77558334	67.16624438
Switzerland	71.9285433	71.17340584	71.60858525	77.98832848	77.39226681
<b>Scandinavian (Swedish) model</b>	<b>45.5</b>	<b>46.3</b>	<b>48.2</b>	<b>61.0</b>	<b>58.8</b>
Denmark	37.79592829	39.9172503	40.06613054	45.16918873	41.80856418
Finland	57.06772248	58.01932838	61.46151773	71.6091286	71.82659044
Iceland	33.01342232	35.84915889	36.59856094	54.45525693	50.73477094
Norway	41.46978611	39.74891965	41.87667821	59.26009173	55.99895991
Sweden	58.24670094	58.03248066	60.9708934	74.39750219	73.80770386
<b>Japanese model</b>	<b>47.5</b>	<b>46.5</b>	<b>48.3</b>	<b>58.6</b>	<b>59.2</b>
Indonesia	37.75165623	34.76245333	37.10766921	54.43350712	56.00033063
Japan	62.56298461	63.57553381	67.06778297	72.68903423	72.96429008
Malaysia	40.99841364	39.0962351	38.46178202	47.77574101	48.66910029
South Korea	48.54415773	48.64440958	50.47213053	59.69368671	59.30591324
<b>Chinese model</b>	<b>22.8</b>	<b>23.9</b>	<b>26.2</b>	<b>36.5</b>	<b>36.7</b>
China	22.83291969	23.89444497	26.17395206	36.51316135	36.68037004
Vietnam	...	...	...	...	...

Source: own elaboration based on (World Development Indicators (WDI) 2022). ... —no data.

## References

- Aksenov, Sergey Mikhailovich. 2006. The Swedish model of society development. *ECO* 2: 137–51. Available online: [https://www.elibrary.ru/download/elibrary\\_9251080\\_81770608.pdf](https://www.elibrary.ru/download/elibrary_9251080_81770608.pdf) (accessed on 15 August 2022).
- An Overview of Economic Measures Applied by Countries in the Context of the Spread of COVID-19. 2020. Roscongress. Available online: [https://roscongress.org/upload/medialibrary/c98/Obzor\\_eco\\_mer\\_final2.pdf](https://roscongress.org/upload/medialibrary/c98/Obzor_eco_mer_final2.pdf) (accessed on 9 September 2022).
- Bardhan, Pranab. 2020. The Chinese governance system: Its strengths and weaknesses in a comparative development perspective. *China Economic Review* 61: 101430. [CrossRef]
- COVID-19 and Related Statistics. 2022. Available online: <https://public.knoema.com/oxosmkg/covid-19-and-related-statistics> (accessed on 31 August 2022).
- Curtis, Steven Kane. 2021. Business model patterns in the sharing economy. *Sustainable Production and Consumption* 27: 1650–71. [CrossRef]
- Data on COVID-19 (Coronavirus) by Our World in Data. 2022. Available online: <https://github.com/owid/covid-19-data/tree/master/public/data/> (accessed on 4 September 2022).
- Durán-Polanco, Liliana, and Mario Siller. 2021. Crowd management COVID-19. *Annual Reviews in Control* 52: 465–78. [CrossRef] [PubMed]
- Faruk, Omar, and Suman Kar. 2021. A Data Driven Analysis and Forecast of COVID-19 Dynamics during the Third Wave Using SIRD Model in Bangladesh. *COVID* 1: 503–17. [CrossRef]
- Gubaidullina, Farida Sabirovna. 2016. Transformation of Economic Model of Japan. *Journal of Modern Competition* 10: 74–89.
- Gueye, Khadim, Abdou Padane, Cyrille Kouligueul Diédhiou, Samba Ndiour, Ndéye Diabou Diagne, Aminata Mboup, Moustapha Mbow, Cheikh Ibrahima Lo, Nafissatou Leye, Aissatou Sow Ndoye, and et al. 2022. Evolution of SARS-CoV-2 Strains in Senegal: From a Wild Wuhan Strain to the Omicron Variant. *COVID* 2: 1116–24. [CrossRef]
- Habibi, Zohal, Hamed Habibi, and Mohammad Aqa Mohammadi. 2022. The Potential Impact of COVID-19 on the Chinese GDP, Trade, and Economy. *Economics* 10: 73. [CrossRef]
- IMF: World Economic Outlook (WEO) Database, April. 2022. Available online: <https://public.knoema.com/wqxlxcg/imf-world-economic-outlook-weo-database-april-2022> (accessed on 23 August 2022).
- Ivanovskiy, Boris Georgievich. 2021. Economic damage from the COVID-19 pandemic and measures to overcome it in the countries of the European Union (Review). *Economic and Social Problem of Russia* 3: 75–87. [CrossRef]
- Kanarsh, Grigorij Y. 2018. Two models of capitalism. *Horizons of Humanitarian Knowledge* 2: 35–51. [CrossRef]



- Keogh-Brown, Marcus R., Henning Tarp Jensen, W. John Edmunds, and Richard D. Smith. 2020. The impact of COVID-19, associated behaviours and policies on the UK economy: A computable general equilibrium model. *SSM—Population Health* 12: 100651. [CrossRef]
- Knoema. 2020. Available online: <https://knoema.com> (accessed on 4 September 2022).
- Kurrey, Ramsingh, and Anushree Saha. 2022. An Overview of SARS-CoV-2 and Technologies for Detection and Ongoing Treatments: A Human Safety Initiative. *COVID* 2: 731–51. [CrossRef]
- Kuznetsov, Aleksei V. 2017. Peculiarities of investment strategies of Japan and the prospects of cooperation with Russia. *Finansy: Teoriya i praktika = Finance: Theory and Practice* 21: 108–17. [CrossRef]
- Lacey King, Erin, Stephan Weiler, Eric Stewart, and Kendall Stephenson. 2022. Multi-Level Nowcasting: Estimation in a Post-COVID Landscape. *Economics* 10: 194. [CrossRef]
- Lee, Won Do, Matthias Qian, and Tim Schwanen. 2021. The association between socioeconomic status and mobility reductions in the early stage of England's COVID-19 epidemic. *Health and Place* 69: 102563. [CrossRef] [PubMed]
- Li, Xin, Eddie C. M. Hui, and Jianfu Shen. 2022. Institutional development and the government response to COVID-19 in China. *Habitat International* 127: 102629. [CrossRef] [PubMed]
- Lukonin, Sergey Aleksandrovich, and Ekaterina Olegovna Zakliazminskaia. 2020. Transformation of the socio-economic model of China in the context of a pandemic. *Outlines of Global Transformations: Politics, Economics, Law* 13: 198–216. [CrossRef]
- Majeed, Abdul. 2021. Effective Handling of COVID-19 Pandemic: Experiences and Lessons from the Perspective of South Korea. *COVID* 1: 325–34. [CrossRef]
- Murewanhema, Grant, Tafadzwa Dzinamarira, Innocent Chingombe, Munyaradzi Paul Mapingure, Solomon Mukwenha, Itai Chitungo, Helena Herrera, Roda Madziva, Solwayo Ngwenya, Godfrey Musuka, and et al. 2022. Emerging SARS-CoV-2 Variants, Inequitable Vaccine Distribution, and Implications for COVID-19 Control in Sub-Saharan Africa. *COVID* 2: 341–49. [CrossRef]
- Paudel, Samrat, Amol Dahal, and Hitesh Kumar Bhattarai. 2021. Temporal Analysis of SARS-CoV-2 Variants during the COVID-19 Pandemic in Nepal. *COVID* 1: 423–34. [CrossRef]
- Plyuhina, Anastasiya Alekseevna. 2020. Theoretical aspects of the concept of socio-economic model and its main elements. In *XX Chayanov Readings, Paper presented at the Russian Economy: New Realities and Development Strategies. Collection of Articles, Moscow, Russian, 19 March 2020*. Moscow: Russian State University for the Humanities, pp. 223–33.
- Population of the World: Data for 2022. 2022. Available online: <https://migrantumir.com/naselenie-stran> (accessed on 23 August 2022).
- Ramazanov, Zamal S. 2010. World socio-economic models and Russia. *Proceedings of Tomsk Polytechnic University* 316: 16–21.
- Salinas, Teresa, Magaly Tejada, Juan José Encinas, Seyyedmilad Talebzadehosseini, and Iván Garibay. 2021. Evolution Scenarios and Mitigation Strategies for COVID-19 in Peru, from the Complexity Approach and Agent-Based Modeling. *COVID* 1: 528–45. [CrossRef]
- Schlickeiser, Reinhard, and Martin Kröger. 2022. Forecast of Omicron Wave Time Evolution. *COVID* 2: 216–29. [CrossRef]
- “Stringency Index” in the Fight against the Pandemic. 2022. Available online: <https://cer.uz/en/post/publication/indeks-strogosti-v-borbe-s-pandemiej> (accessed on 25 August 2022).
- Tang, Wenguang, Jian Hu, Geovanny Genaro Reivan Ortiz, Fatma Mabrouk, and Jinghuan Li. 2022. Research on the Impact of COVID-19 on Import and Export Strategies. *Frontiers in Environmental Science* 10: 891780. [CrossRef]
- Tcerkasevich, Larisa. 2019. Myths and Reality of the Swedish “People’s Home”. *Sovremennaya Evropa = The Modern Europe* 2: 163–74. [CrossRef]
- Teng, Bin, Sicong Wang, Yufeng Shi, Yunchuan Sun, Wei Wang, Wentao Hua, and Chaojun Shi. 2022. Economic recovery forecasts under impacts of COVID-19. *Economic Modelling* 110: 105821. [CrossRef] [PubMed]
- Teterina, Tatiana. 2015. The History of the Formation of Modern Economic System. *Vestnik Universiteta* 1: 111–15.
- Tsedilin, Leonid Ivanovich. 2019. Modern Model of Social and Economic Development of China: Identification and Analysis. *Bulletin of the IE RAS* 3: 126–36.
- Vasin, Sergey Mikhailovich. 2022. Sectoral Transformation of the Economic System during Crisis and Stable Growth Periods (A Case Study of the European Countries). *Economics* 10: 148. [CrossRef]
- World Bank Global Economic Monitor. 2022. Available online: <https://public.knoema.com/qhpqgye/world-bank-global-economic-monitor> (accessed on 16 August 2022).
- World Development Indicators (WDI). 2022. Available online: <https://public.knoema.com/lftihvf/world-development-indicators-wdi> (accessed on 16 August 2022).
- World Health Organization. 2020. WHO Announces COVID-19 Outbreak a Pandemic. Available online: <https://www.euro.who.int/en/health-topics/health-emergencies/coronavirus-covid-19/news/news/2020/3/who-announces-covid-19-outbreak-a-pandemic/> (accessed on 20 April 2022).
- World Health Organization. 2022. Situation by Region, Country, Territory & Area. Available online: <https://covid19.who.int/table> (accessed on 23 August 2022).
- World Pandemic Uncertainty Index. 2022. Available online: <https://public.knoema.com/djnymtf/world-pandemic-uncertainty-index> (accessed on 27 August 2022).

MDPI  
St. Alban-Anlage 66  
4052 Basel  
Switzerland  
Tel. +41 61 683 77 34  
Fax +41 61 302 89 18  
[www.mdpi.com](http://www.mdpi.com)

*Economies* Editorial Office  
E-mail: [economies@mdpi.com](mailto:economies@mdpi.com)  
[www.mdpi.com/journal/economies](http://www.mdpi.com/journal/economies)







Academic Open  
Access Publishing

[www.mdpi.com](http://www.mdpi.com)

ISBN 978-3-0365-7797-5